



We are America's Cabinetmaker.®



EXPRESS®
PRODUCT LINE
SPEC BOOK

OUR
STREAMLINED
PRODUCT
LINE



We are America's Cabinetmaker.®

Looking for Merillat Express® sales support? These resources can help.

Merillat.com

This consumer-facing website offers many ways to inspire organizational solutions in beautiful cabinetry options, as well as drives business to our dealers. Here are some highlights:

- View inspirational designs and photos.
- Download floor plan drawings from photosets to gather design ideas.
- Visualize door styles by wood species and finish.
- Use the "Features & Accessories for Your Lifestyle" to view organizational solutions by room type.
- Engage consumers by directing them to the "Step-by-Step Kitchen Planner" to create a mood board to share with their designer.
- Educate consumers about wood characteristics, installation, Merillat Cabinetry sustainability initiatives, and dos and don'ts of cabinetry care.

MerillatBusiness.com

If you're not currently registered for MerillatBusiness.com, you could be missing important product and brand information that can assist you with your Merillat Cabinetry sales efforts. It's quick and easy, so visit the site and register today. It will enable you to:

- Check order status.
- Download or order product literature, like the product brochure, specification and price books, door/style finish codes, and 2020 Design updates. (For questions on 2020 Design, email ecatalogsupport@mascocabinetry.com.)
- Download promotional materials, such as brand campaign print ads, direct mail postcards, videos and counter cards.
- Order samples and displays, like wood chips, selection centers, and sample doors and backer cards.

Automated Orders proCAB™

proCAB™ is an online, web-based, real-time order management solution available for Merillat Cabinetry product lines. Sign up today if you don't already have an account. Benefits of proCAB™ are:

- Order Entry and Inquiry
- Import Kitchen Designs from 2020
- No Charge Shortage and Damage Ordering
- Quote Order Capabilities
- Expedite Requests
- Shipment Status Inquiry
- Product Inquiry Search
- Document Imaging to retrieve copies of acknowledgements, invoices, and shipping reports
- ACH electronic payment of your invoices
- Outstanding Invoices
- View open and paid invoices
- View check number that paid a specific invoice and payment receipts

For more information, please contact us directly at **(866) 626-1621** or proCABsupport@mascocabinetry.com

Order Confirmation and Tracking

You can monitor your order using MerillatBusiness.com or proCAB™. Simply login to review your confirmation that your order has been received and to also track its progress.

Merillat Express® Cancellation Policy

Merillat Express® cabinetry is made to order. That means we don't start building your cabinets until your order is placed. Due to our fast 5-day shipping schedule, orders are fulfilled as quickly as possible, affecting our ability to accept cancellations. To consistently maintain the quick 5-day shipping schedule, our policy is that orders cannot be canceled once placed.

Merillat Customer Care Resources

Electronic means are convenient, but sometimes you just need to talk to a person, and Merillat Customer Care consultants are here to help. Your consultant can help you:

- Order product.
- Follow up on orders or track delivery progress.
- Discuss product situations or address invoice questions.

Your Merillat® Account Manager is there to help you every step of the way. Make sure to contact them whenever you have questions, concerns or need information.

Additional assistance is available through Customer Care:

(855) 896-9803 or distribution@mascocabinetry.com

Hours M-F 8:00 am – 6:00 pm EST

For Order Placement:

Fax **(866) 998-4432** or orderentry@mascocabinetry.com

Kitchen Cabinet Manufacturers Association



All products impact the environment. For ESP program criteria, visit greencabinetsource.org.



Merillat Cabinetry carries the seal of the Kitchen Cabinet Manufacturers Association (KCMA) Certification Program, which assures that our cabinets meet or exceed the rigorous standards set by the American National Standards Institute (ANSI). Our cabinets are also independently tested to ANSI/KCMA A161.1-2000 and paragraph 611-1.1, "HUD Minimum Property Standards-Housing 4910.1" 9-8-86.

Merillat Cabinetry demonstrates its commitment to environmental sustainability through meeting or exceeding the requirements as outlined in the Environmental Stewardship Program certification, administered by the KCMA.

All Merillat Cabinetry facilities have also obtained ISO 14001 certificate of approval, demonstrating our commitment to reducing the impact of operations on the environment.

Construction and assembly methods may vary from what is shown in samples and imagery, but do not affect KCMA certification or performance standards of products.

 **WARNING:** This product can expose you to chemicals including formaldehyde, which is known to the State of California to cause cancer. For more information go to www.P65Warnings.ca.gov.



We are America's Cabinetmaker.®

Express™ Product Line

Specifications

Table of Contents

Merillat Express® Specifications Book

What's New	1-6	Office Cabinets	H1-H2
Code System	3-4	Office Cabinets	H1
Understanding Product Codes	5-6	Office Accessories	H2
Index	i-ii	Panels-Shelving-Trays	I1-I6
Door Styles	A1-A8	Panels	I1
Finishes	B1-B2	Shelving	I2
Cabinet Specifications and Options	C1-C6	Trays	I3-I6
Cabinet Specifications	C1	Decorative Enhancements	J1-J10
Construction Options	C2-C6	Supports & Valances	J1
Wall Cabinets	D1-D12	Moldings	J2-J6
Wall Cabinets	D1-D3	Decorative Hardware Knobs	J7-J8
Wall Corner Cabinets	D4-D7	Decorative Hardware Pulls	J9-J10
Wall Open Cabinets	D8	Replacement Parts	K1-K20
Wall Appliance Cabinets	D9	Hardware	K1-K7
Wall Accessories	D10-D12	Touch Up Materials	K8-K10
Base Cabinets	E1-E16	Sales Doors	K11
Base Cabinets	E1-E3	Understanding Replacement Parts	K12-K13
Base Sink Cabinets	E4-E7	Doors and Drawer Fronts - Sizes	K14-K16
Base Corner Cabinets	E8-E11	Accessory Non-Drilled Doors -Sizes	K17-K18
Base Accessories	E12-E16	Framed Cabinet Specifications	K19
Tall Cabinets	F1-F6	Use and Care	K20
Tall Cabinets	F1-F2	Index	
Tall Appliance Cabinets	F3-F4	Nomenclature Index	L1-L2
Tall Accessories	F5-F6		
Vanity Cabinets	G1-G10		
Vanity Cabinets	G1-G7		
Vanity Accessories	G8-G10		

What's New for the Merillat Express® product line in 2017

Watch for this icon highlighting new items

Watch for grey codes and this note highlighting new models or codes

CVLM8 *Gray color coding indicates new product, size or code*

New Product

Construction Options Page

Case Only Option (CSO) C6

Trays Page

Base Tray Kit- Double Faced, Standard in 36" I3

Vanity Tray Kit- Space Saver in 21" I4

Moldings Page

Cove Large Molding J3

Cove Light Rail Molding J3

Hardware Page

Door Stop Kit K7

What's Changed

Base Corner Revolving now available in traditional overlay door styles

What's Discontinued

Moldings

Inset Light Rail

Contemporary Crown Molding

Code System

Merillat Express® Ordering Code

Merillat® builds its order code from global options, model, and model options which together define an orderable item. The order code is created from the door, finish, construction, cartoning, model and model options to complete the order code. The order code can incorporate all possible combinations available in the Merillat Express® product line. Each order code **must** be complete to be recognized as a unique product. By understanding the Merillat® code system you can identify any product with any variation or option in one place. Following is a breakdown of each order code segment and how it combines to make a full order code. Each segment is identified with an identification number. That number will be repeated on this page and every page where the specification of product relates to a segment position of the order code.

①	②	③	④	⑤	⑥	⑦	⑧	⑨	⑩
MR5	.HW	.S	.KONON	.N	.NNNN	.SST	.S	.C	.B15LHDS
Door Style	Species	Door Shape	Finish			Cabinet Construction	Drawer Front Construction	Carton	Model + Options

① Door Style Code

Arbor Falls Express	AB5
Marlin Express	MR5
Portrait Express	PR5
Ralston Express	RA5
Seneca Ridge Express	SN5
Spring Valley Express	SV5

② Species Code

Hardwood	HW
Maple	MP
Red Oak	RO
Thermofoil	TH

③ Door Shape Code

Square	S
--------	---

④ Stain Finishes Code

Amaretto	ARNON
Kona	KONON
Pecan	PCNON
Sable	SBNON
Sedona	SDNON
Toffee	TFNON

④ Stain w/Accent Glaze Finishes Code

Sable w/Ebony Accent	SBEBZA
Sedona w/Ebony Accent	SDEBZA
Toffee w/Java Accent	TFJVA

④ Stain w/Glaze Finishes Code

Sable w/Ebony Glaze	SBEBZ
Toffee w/Java Glaze	TFJVZ

④ Painted Finish Code

Chiffon	CHNON
Cotton	CTNON

④ Painted Finish w/Accent Glaze Code

Chiffon w/Desert Accent	CHDSA
Chiffon w/Tuscan Accent	CHTNA
Cotton w/Tuscan Accent	CTTNA

④ Painted Finish w/Glaze Code

Chiffon w/Desert Glaze	CHDSZ
Chiffon w/Tuscan Glaze	CHTNZ
Cotton w/Tuscan Glaze	CTTNZ

④ Thermofoil Finishes Code

White	WHNON
-------	-------

- ⑤ This attribute is being held for future use to indicate special finishing options

N

- ⑥ This attribute is being held for future use to indicate special construction material options

NNNN

⑦ **Cabinet Construction**

⑦a

**Cabinet
Construction
Code**
S

⑦b

**Drawer
Box
Code**
S, D

⑦c

**Thick
Shelf
Code**
T

Options

Code

Standard Construction, Standard Drawers, Thick Shelves SST
Standard Construction, Dovetail Drawers, Thick Shelves SDT

⑧ **Drawer Front** **Code**
Solid Drawer Front S

⑨ **Cartoning** **Code**
Cartoned C

⑩ **Model + Options**

⑩a

⑩c

⑩d

⑩g

Model	Hinging	Code	Tray/Shelf	Code	Partial Cabinet	Code
W1842	Left	L	Half Depth Shelf	HDS	Cabinet Front Only	CFO
B21	Right	R	Full Depth Shelf	FDS		
B30B			1 Standard Tray	1ST		
B39			2 Standard Trays	2ST	Case Only	CSO
U188424			4 Standard Trays	4ST		
VCD2435DL			1 Standard Full Width Tray	1FT		
			2 Standard Full Width Trays	2FT		

Model + Option Code Examples

	Code
Wall Single Door Cabinet 18" Wide x 42" High x 12" Deep Hinged Right	W1842R
Base Single Door Cabinet 21" Wide Hinged Right with 1 Standard Tray	B21R1ST
Base Butt Double Door Cabinet 30" Wide with Half Depth Shelf	B30BHDS
Base Single Door Cabinet 39" Wide 4 Standard Trays	B394ST
Utility Cabinet Single Door 18" Wide x 96" High x 24" Deep Hinged Right with Cabinet Front Only	U189624RCFO
Vanity Combination Drawer 24" Wide x 34 1/2" High Drawers Left	VCD2435DL

Understanding Product Codes

Standard Cabinets

Wall Cabinet widths are always listed first followed by height. A standard wall cabinet is 12" deep except for Wall Refrigerator Cabinets which have a standard depth of 24". Thus 36 is the width, 24 is the height and depth is 12". Depth is only listed as the last two numbers when depth is other than standard. Cabinets with a "B" suffix have BUTT doors without a frame center stile.

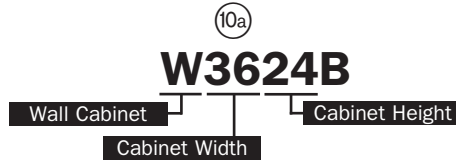

Tall cabinets follow the same sequence characteristics as Wall Cabinets; width first followed by height (eg; U 1884). In those instances where the cabinet depth is greater than 12", the sequence is width and height, followed by depth eg; U 188424).

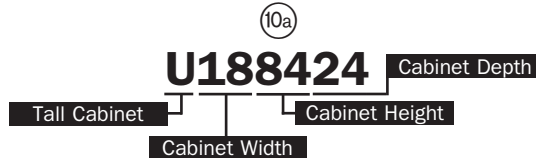

Base Cabinets are simpler than Wall Cabinets because the height (34 1/2" plus 1 1/2" for the countertop) and the depth (24") are always the same unless otherwise noted. The only numbers you need to know are the width. Cabinets with a "B" suffix have BUTT doors without a frame center stile.



Vanity Cabinets are similar to Base Cabinets; the numbers are used to represent the width. Vanity Sink Base Cabinets are either 31 1/2" or 34 1/2" high plus 1 1/2" for the countertop. This particular cabinet is 31 1/2" high and comes standard with two drawers and is located at the end of the code.

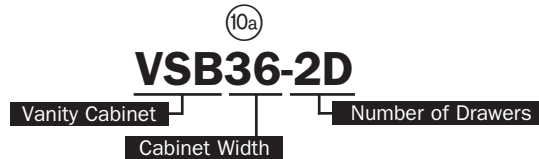

Cabinets with Options

Trays are an available option for select Base Cabinets. The option of 2 Standard Trays has been chosen for this cabinet. The code looks the same as it did before with (2ST) placed at the end.

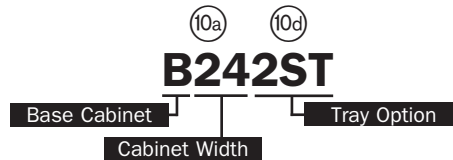

ITEM	PAGE	ITEM	PAGE	ITEM	PAGE
1		C		Narrow Batten Molding	J4
1 Standard Full-Width Tray	C6	Cabinet Care Kit	K8	O	
1 Standard Tray	C5	Cabinet Cleaning and Polishing Cloths	K8	Ochre Finished Ceramic Totem Knob	J8
170 Degree Hinge	K4	Cabinet Dusting Cloths	K8	Ochre Finished Ceramic Totem Pull	J9
2		Cabinet Front Only	C6	Oil Rubbed Bronze Cup Pull	J9
2 Standard Full-Width Trays	C6	Case Only Option	C6	Oil Rubbed Bronze Round Knob	J8
2 Standard Trays	C5	Chrome Traditional Pull	J10	Oven Cabinet Single	F4
3		Classic Crown Molding	J3	Oven Cabinet Support Platform	F4
3/4 Extension Side Mount Roller Guide Kit	K1	Copper-Pewter Knob	J7	Oven Cabinet Universal	F3
3/4 Extension Side Mount Roller Guide Peninsula Base Kit	K1	CoreGuard® Panel Backer	I1	Oven Drawer Kit	F4
3/4 Extension Side Mount Roller Guides	K1	CoreGuard® Sink Base	E4		
3/4" Shelf Clip	K6	Corner Molding	J2	P	
3/4" Shelf Clip with Stop	K6	Countertop Molding - Decorative Edge	J2	Panel Backer-Paper	I1
4		Countertop Support Bracket	J1	Panel Backer-Veneer	I1
4 Standard Trays	C5	Cove Light Rail Molding	J3	Peninsula Base Butt Door	E3
A		Cove Molding	J3	Peninsula Base Butt Door Blind Corner	E9
Angle Crown Molding	J2	Crown Molding	J3	Peninsula Base Single Door	E2
Antique Iron Knob	J7	Cutlery Divider	E13	Peninsula Base Single Door Blind Corner	E9
Antique Pewter Braided Knob	J7	D		Peninsula Wall Angle	D6
Antique Pewter Braided Pull	J9	Desk End Panel	H2	Peninsula Wall Double Door	D3
Antique Pewter Flower Knob	J7	Desk Knee Drawer	H1	Peninsula Wall Single Door	D2
Arbor Falls Express	A2	Door and Frame Assembly Sales Samples	K11	Portrait Express	A4
		Door Stop Kit	K7		
		Dusty Copper Flower Knob	J7	Q	
B		F		Quarter Round Molding	J4
Back Plugs	K7	Full Depth Shelf	C5		
Base Blind Corner	E9	Full Extension Side Mount Ball Bearing Guide Kit	K1	R	
Base Corner Fixed Shelf	E11	Full Extension Side Mount Ball Bearing Guides	K2	Ralston Express	A5
Base Corner Revolving	E10	Full Extension Under Mount Soft Action+ Guides	K2	Rear Mounting Bracket - 3/4 Extension Side Mount Roller Guides	K3
Base Double Door	E2	Full Extension Under Mount Soft Action+ Peninsula Base Guide Kit	K2	Rear Mounting Bracket - 3/4 Extension Side Mount Roller Guides Peninsula Base	K3
Base Double Door Full-Height	E2	Full Extension Under Mount SoftAction+ Guide Kit	K2	Rear Mounting Bracket - Full Extension Side Mount Ball Bearing Guides	K4
Base End Panel	E15	Full Overlay 6 Way Hinge	K5	Rear Mounting Bracket - Full Extension Under Mount Soft Action+ Guides	K3
Base End Panel Filler	E14			Rear Mounting Bracket - Full Extension Under Mount Soft Action+ Guides DKD	K3
Base Filler	E14	H		Rear Mounting Bracket - Full Extension Under Mount Soft Action+ Guides Peninsula Base	K3
Base Filler Corner	E14	Half Depth Shelf	C5	Roll-Out Trays - Solid Wood	I5
Base Four Drawer	E3	Hardware Template Kit Universal	K7	Rusty Flower Knob	J7
Base Lazy Susan	E10	L			
Base Single Door	E1	Large Starter Molding	J6	S	
Base Single Door Full-Height	E1	Lazy Susan Revolving Shelf Kit (One Shelf)	D10	Sales Door	K11
Base Three Drawer	E3	Lazy Susan Revolving Shelf Kit (Three Shelves)	D10	Satin Aluminum Boat Cleat Transitional Pull	J9
Base Tray Kit - Double Faced, Standard	I3	Locking Device - Full Extension Under Mount Soft Action+ Guides	K2	Satin Aluminum Knob	J7
Base Tray Kit - Standard	I3			Satin Nickel Canoe Pull	J9
Base Wastebasket Floor Mount Kit Double	E12	M		Satin Nickel Diminishing Knob	J8
Base Wastebasket Floor Mount Kit Single	E12	Marlin Express	A3	Satin Nickel Football Shaped Knob	J8
Base Wastebasket Top Mount	E3	Matching Base End Panel	E15	Satin Nickel Fusilli Pull	J9
Base Wastebasket Top Mount Kit	E12	Matching Tall End Panel	F6	Satin Nickel Knob	J7
Bi-Fold Hinge	K4	Matching Vanity End Panel	G9	Satin Nickel Knob	J7
Black Ceramic Insert Pull	J9	Matching Wall End Panel	D11	Satin Nickel Knob	J7
Black Ceramic Insert Round Knob	J8	Medicine Cabinet	G6	Satin Nickel Knob	J7
Black Nickel Knob	J7	Medicine Cabinet Pack Hinge	K5	Satin Nickel Rope Knob	J7
Black Nickel Traditional Pull	J10				
Bookcase Cabinets	D8	N			
Bright Brass Traditional Pull	J10				
Bright Chrome Knob	J7				
Brushed Satin Pewter French Tassel Pull	J9				
Brushed Satin Pewter French Tassel Round Knob	J8				

ITEM	PAGE	ITEM	PAGE	ITEM	PAGE
Satin Nickel Rope Pull	J9	Utility Tray Kit	E13		
Satin Nickel Suitcase Pull	J9				
Satin Nickel Traditional Pull	J9	V			
Satin Nickel Traditional Pull	J10	Vanity Base Double Door	G1		
Satin Nickel Wavy Pull	J9	Vanity Base Double Door Full-Height	G2		
Satin Nickel Wire Cable Pull	J9	Vanity Base Four Door Full-Height	G2		
Scribe Molding	J5	Vanity Base Single Door	G1		
Seneca Ridge Express	A6	Vanity Base Single Door Full-Height	G1		
Shelf Kits	I2	Vanity Base Three Door Full-Height	G2		
Shelf Support Back Pack	K6	Vanity Combination Drawer Eight Drawer Double Door	G5		
Shelf Support Center	K6	Vanity Combination Drawer Eight Drawer Single Door	G5		
Shelf Support Pack	K6	Vanity Combination Drawer Six Drawer Double Door	G5		
Shoe Molding	J5	Vanity Combination Drawer Six Drawer Single Door	G4		
Single Bead Trim	J5	Vanity Combination Drawer Three Drawer	G4		
Sink Base Angle	E7	Vanity Combination Drawer Two Drawer	G4		
Sink Base Double Door	E5	Vanity Drawer Three Drawer	G5		
Sink Base Double Door Full-Height	E6	Vanity Filler	G8		
Sink Base Single Door	E5	Vanity Linen Cabinet Tall	G6		
Sink Base Single Door Full-Height	E5	Vanity Sink Base Butt Door	G2		
Sink Front Bottom	E13	Vanity Sink Base Double Bowl	G3		
Sink Front Double Door	E6	Vanity Sink Base Two Drawer Double Door	G3		
Sink Front Double Door Full-Height	E7	Vanity Sink Base Two Drawer Four Door	G4		
Sink Front Single Door	E6	Vanity Sink Base Two Drawer Three Door	G3		
Sink Front Single Door Full-Height	E6	Vanity Tray Kit	I4		
Soffit Crown Molding	J4	Vanity Tray Kit - Space Saver	I4		
SoftAction Door Hardware	K7	Vanity Wall - 4 3/4" Deep	G6		
Solid Bright Brass Knob	J7	Vanity Wall Boutique - 7" Deep	G6		
Solid Wood Stock	J5	Venetian Bronze Copper French Lace Knob	J8		
Spring Valley Express	A7	Vent Clip Pack	K7		
		W			
T		Wall Angle Single Door	D6		
Tall End Panel	F6	Wall Blind Corner Double Door	D5		
Tall End Panel Filler	F6	Wall Blind Corner Single Door	D5		
Tall Filler	F5, G8	Wall Corner Angle	D7		
Tall Utility Cabinet 12" Deep	F1	Wall Double Door	D2		
Tall Utility Cabinet 24" Deep	F2	Wall End Panel	D11		
Toe Kick Cover - Laminate	E13, F5, G9	Wall Filler	D11		
Toe Kick Cover - Veneer	E13, F5, G9	Wall Filler Corner	D11		
Touch Up Kit	K9	Wall Lattice	D8		
Touch Up Pen	K9	Wall Microwave Shelf	D9		
Touch Up Quart	K9	Wall Refrigerator	D2		
Touch Up Spray Can Primer	K9	Wall Single Door	D1		
Touch Up Spray Can Topcoat	K9	White Ceramic Knob	J7		
Traditional Furniture Base	J4	White Fusilli Pull	J9		
Traditional Overlay 6 Way Hinge	K5				
Tri-View Medicine Cabinet	G7				
Tumbled Dark Gunmetal Mission Style Ringed Pendant Pull	J9				
Tumbled Dark Gunmetal Round Knob	J8				
U					
Under Cabinet Molding	J6				
Utility Front	F2				
Utility Tray Hinge	K5				

Wood Species

Hardwood is considered highly durable, making it well suited for furniture and cabinetry. Hardwood is a general term used to classify several types of trees that wood comes from; it can refer to a number of species (e.g. Birch, Maple, and Red Oak)

Maple is a popular choice featuring a fine uniform grain that takes color quite well. Maple is versatile and available in nearly every color combination. A very consistent wood type.

Red Oak is a heavy, hardwood, and has a medium-fine, noticeable grain. It gives you dramatic lines that play quite differently off of each color.

Thermofoil is a solid colored vinyl that is applied to smooth, engineered wood or Medium Density Fiberboard (MDF), easy to clean and built to last. Thermofoil cabinetry gives you a uniform appearance.

Arbor Falls Express

Traditional Overlay

① ② ③ ⑧
AB5. TH. S. S

Thermofoil

- White vinyl laminated MDF with raised center panel on door
- White vinyl laminated MDF slab drawer front
- Doors and drawer fronts have a 90° return with an integrated finger pull
- Cabinet face frame is White painted hardwood
- Concealed hinge
- Decorative hardware is optional

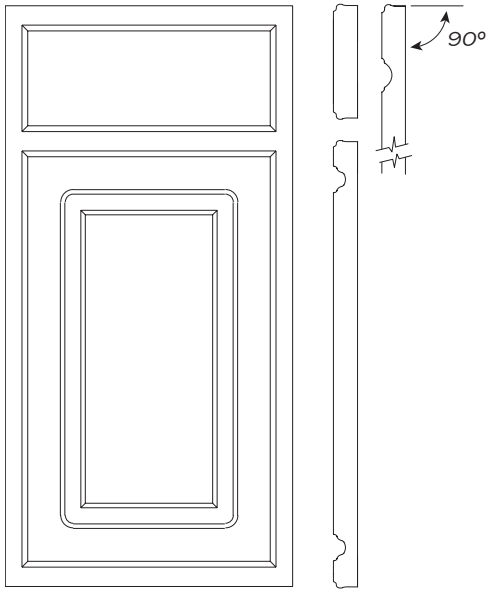

Thermofoil

Thermofoil

White (WHNON)

Marlin Express

Traditional Overlay

① ② ③ ⑧

MR5.HW. S. S Hardwood w/Solid Drawer Front

- Solid hardwood door frame with 2" stiles and rails
- Recessed, flat veneer center panel
- Door and drawer front have horizontal reverse bevels
- Slab drawer front is solid wood
- Doors with painted finishes will either have a recessed veneer or Medium Density Fiberboard (MDF) panel
- Concealed hinge
- Decorative hardware is optional

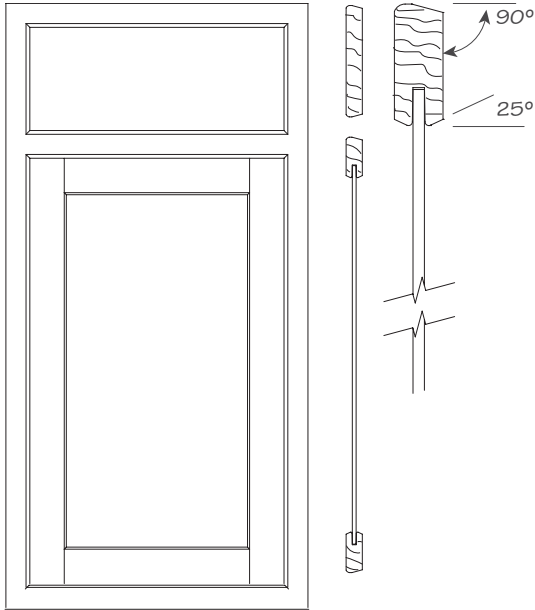

Hardwood

Stain Finishes

Kona (KONON)
Pecan (PCNON)

Painted Finishes*

Cotton (CTNON)

*Available with an upcharge

Portrait Express

Full Overlay

① ② ③ ⑧
 PR5 . MP . S . S

Maple w/Solid Drawer Front

- Solid wood door frame with 2 3/16" stiles and rails
- Recessed, flat, veneer center panel door
- Doors and drawers have a 90° return with no reverse bevel
- Doors with painted finishes will either have a recessed veneer or Medium Density Fiberboard (MDF) panel
- Slab drawer front is solid wood
- Concealed hinge
- Decorative hardware is required

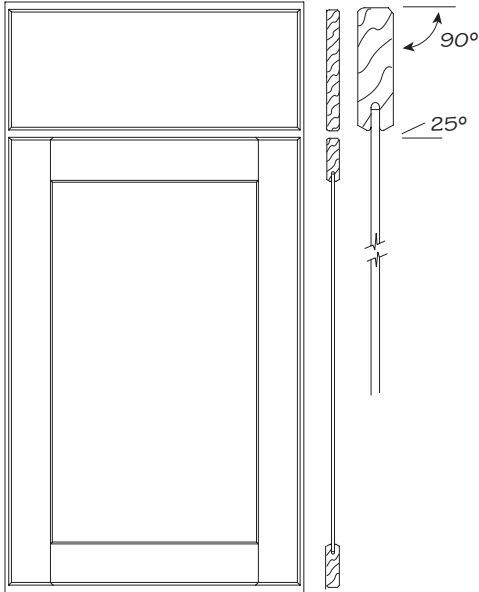

Door Styles

Maple

Stain Finishes

Kona (KONON)
 Sable (SBNON)
 Sedona (SDNON)
 Toffee (TFNON)

Maple (cont.)

Painted Finishes*

Chiffon (CHNON)
 Cotton (CTNON)

*Available with an upcharge

Ralston Express

Full Overlay



RA5.MP. **S.** **S** Maple w/Solid Drawer Front

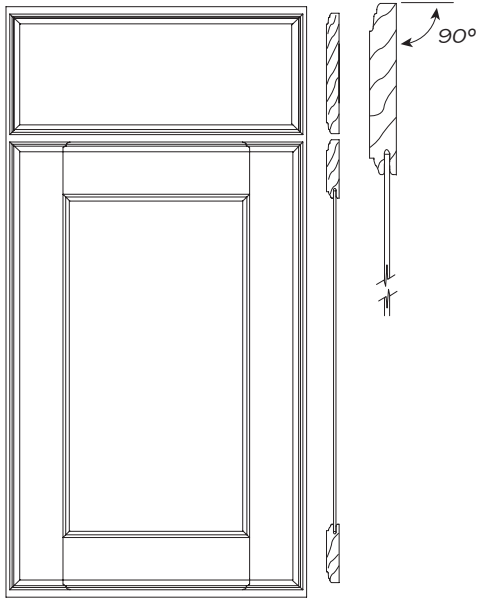

- Solid wood door frame with 3" stiles and rails
- Recessed, flat, veneer center panel door
- Doors and drawers have a 90° return with no reverse bevel
- Doors with painted finishes will either have a recessed veneer or Medium Density Fiberboard (MDF) panel
- Slab drawer front is solid wood
- Concealed hinge
- Decorative hardware is required

Maple

Stain Finishes

Kona (KONON)
Sable (SBNON)
Sedona (SDNON)
Toffee (TFNON)

Stain w/ Glaze Finishes*

Sable w/Ebony Glaze (SBEBZ)
Toffee w/Java Glaze (TFJVZ)

Maple (cont.)

Painted Finishes*

Chiffon (CHNON)
Cotton (CTNON)

Painted w/Traditional Glaze Finishes*

Chiffon w/Desert Glaze (CHDSZ)
Chiffon w/Tuscan Glaze (CHTNZ)
Cotton w/Tuscan Glaze (CTTNZ)

*Available with an upcharge

Seneca Ridge Express

Traditional Overlay

① ② ③ ⑧

SN5. MP.
SN5. RO.

S. S
S. S

Maple w/Solid Drawer Front
Red Oak w/Solid Drawer Front

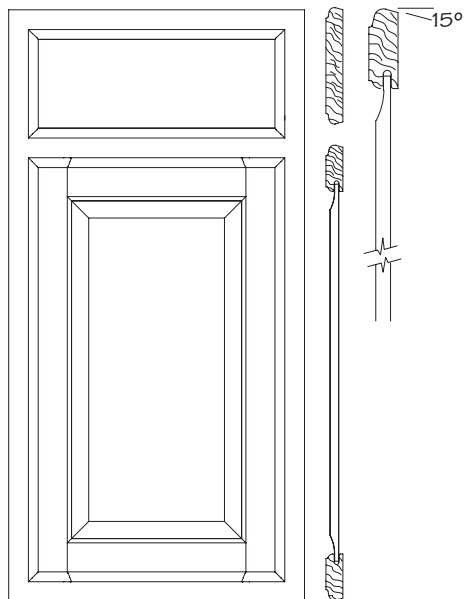

- Solid wood door frame with 2 3/16" stiles and rails
- Wood veneer, raised center panel door
- Top and bottom edges of doors and drawers have a 15° reverse bevel
- Doors with painted finishes will either have a raised, veneer or Medium-Density Fiberboard (MDF) center panel
- Slab drawer front is solid wood
- Concealed hinge
- Decorative hardware is optional

Maple

Stain Finishes

Kona (KONON)
Sable (SBNON)
Sedona (SDNON)
Toffee (TFNON)

Stain w/Accent

Glaze Finishes*

Sable w/Ebony Accent (SBEBA)
Sedona w/Ebony Accent (SDEBA)
Toffee w/Java Accent (TFJVA)

Maple (cont.)

Painted Finishes*

Chiffon (CHNON)
Cotton (CTNON)

Painted w/Accent

Glaze Finishes*

Chiffon w/Desert Accent (CHDSA)
Chiffon w/Tuscan Accent (CHTNA)
Cotton w/Tuscan Accent (CTTNA)

Red Oak

Stain Finishes

Amaretto (ARNON)
Pecan (PCNON)

*Available with an upcharge

Spring Valley Express

Traditional Overlay

① ② ③ ⑧
 SV5. MP. S. S
 SV5. RO. S. S

Maple w/Solid Drawer Front
 Red Oak w/Solid Drawer Front

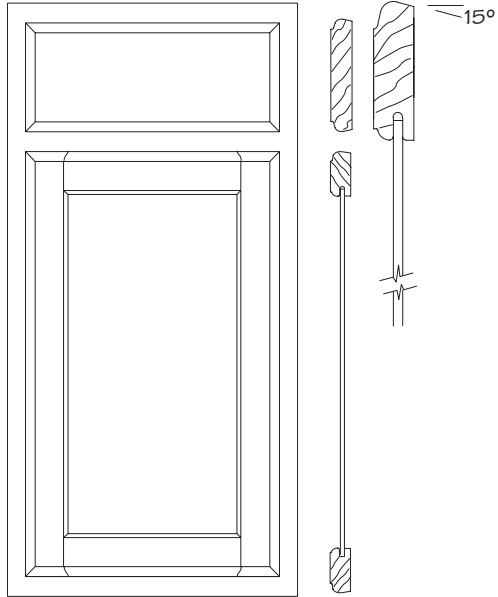

- Solid wood door frame with 2 3/16" stiles and rails
- Recessed, flat, veneer center panel door
- Top and bottom edges of doors and drawers have a 15° reverse bevel
- Doors with painted finishes will either have a recessed veneer or Medium Density Fiberboard (MDF) panel
- Slab drawer front is solid wood
- Concealed hinge
- Decorative hardware is optional

Maple

Stain Finishes

Kona (KONON)
 Sable (SBNON)
 Sedona (SDNON)
 Toffee (TFNON)

Stain w/Accent

Glaze Finishes*

Sable w/Ebony Accent (SBEBA)
 Sedona w/Ebony Accent (SDEBA)
 Toffee w/Java Accent (TFJVA)

Maple (cont.)

Painted Finishes*

Chiffon (CHNON)
 Cotton (CTNON)

Painted w/Accent

Glaze Finishes*

Chiffon w/Desert Accent (CHDSA)
 Chiffon w/Tuscan Accent (CHTNA)
 Cotton w/Tuscan Accent (CTTNA)

Red Oak

Stain Finishes

Amaretto (ARNON)
 Pecan (PCNON)

*Available with an upcharge

Notes

Merillat Express® Finishes and Wood Species

① ② ③ ④ ⑤ ⑥ ⑦ ⑧ ⑨ ⑩
MR5 . HW . S . KONON . N . NNNN . SST . S . C . B15

End grain surfaces and softer areas of the wood may accept more stain and often appear darker than other surfaces. Since wood is in a constant state of expansion and contraction, visible lines are normal at the joints on the cabinet face frames and doors.

All wood species show some wood grain. The amount of grain will vary by species and finish. Maple is a closed or fine grain wood that can have mineral streaks and pin holes. When paint is applied to Maple these beauty marks may remain slightly visible.

Stain Finishes

Stain Process

Stain is applied and brush-wiped to desired color. Next, sealer is applied to protect the finish and prevent warping and cracking of the wood. Sealer is then sanded to develop a bonding surface for the topcoating process.

Amaretto

Rich golden brown

ARNON Red Oak

Kona

Deep semi-transparent dark brown

KONON Hardwood and Maple

Pecan

Warm rich brown with deep brown undertones and black overtones

PCNON Hardwood and Red Oak

Sable

Rich medium brown

SBNON Maple

Sedona

Rich traditional cherry finish on maple

SDNON Maple

Toffee

Warm brown

TFNON Maple

Stain w/Accent Glaze Finishes

Stain w/Accent Glaze Process

Stain is applied and brush-wiped to desired color. Next, sealer is applied to protect the finish and prevent warping and cracking of the hardwood. Sealer is then sanded to develop a bonding surface for the accent glazing and topcoat process.

Accent glaze is applied by hand to specific door and drawer front profiles depending on door style and then cured.

Sable w/Ebony Accent

Rich medium brown with charcoal (black) accent glaze

SBEBA Maple

Sedona w/Ebony Accent

Rich traditional cherry finish with charcoal (black) accent glaze

SDEBA Maple

Toffee w/Java Accent

Warm brown with dark brown accent glaze

TFJVA Maple

Stain w/Glaze Finishes

Stain w/Traditional Glaze Process

Stain is applied and brush-wiped to desired color. Next, sealer is applied to protect the finish and prevent warping and cracking of the hardwood. Sealer is then sanded to develop a bonding surface for the glazing and topcoat process.

Glaze is hand applied by hand face side only to corner hang-ups and profile recesses depending on door style.

Sable w/Ebony Glaze

Rich medium brown with charcoal (black) glaze

SBEBZ Maple

Toffee w/Java Glaze

Warm brown with dark brown glaze

TFJVZ Maple

Painted Finishes

Paint Process

Our painted finishes consist of several coats of pigmented semi-opaque enamel paint that is allowed to saturate the wood developing richness while allowing some of the natural grain to remain visible.

Chiffon

Cream

CHNON Maple

Cotton

White

CTNON Hardwood and Maple

Paint w/Accent Glaze Finishes

Paint w/Accent Glaze Process

Several coats of pigmented semi-opaque enamel paint is applied and allowed to saturate the hardwood developing richness while allowing some of the natural grain to remain visible. Next, sealer is applied to protect the finish and prevent warping and cracking of the hardwood. Sealer is then sanded to develop a bonding surface for the accent glazing and topcoat process.

Accent glaze is hand applied to specific door and drawer front profiles depending on door style and then cured.

Chiffon w/Desert Accent

Cream with brown accent glaze

CHDSA Maple

Chiffon w/Tuscan Accent

Cream with light gray accent glaze

CHTNA Maple

Cotton w/Tuscan Accent

White with light gray accent glaze

CTTNA Maple

Paint w/Glaze Finish

Paint w/Traditional Glaze Process

Several coats of pigmented semi-opaque enamel paint is applied and allowed to saturate the wood developing richness while allowing some of the natural grain to remain visible. Next, sealer is applied to protect the finish and prevent warping and cracking of the wood. Sealer is then sanded to develop a bonding surface for the glazing and topcoat process.

Glaze is applied, face side only, to corner hang-ups and profile recesses depending on door style.

Chiffon w/Desert Glaze

Cream with brown glaze

CHDSZ Maple

Chiffon w/Tuscan Glaze

Cream with light gray glaze

CHTNZ Maple

Cotton w/Tuscan Glaze

White with light gray glaze

CTTNZ Maple

Thermofoil Finishes

Thermofoil

Heavy gauge vinyl laminate is applied with thermo-pressure to door and drawer front and edges

White

Solid white color with satin finish

WHNON Thermofoil

Notes

Cabinet Specifications

Construction Options and Modifications

Full Overlay - Concealed Hinges

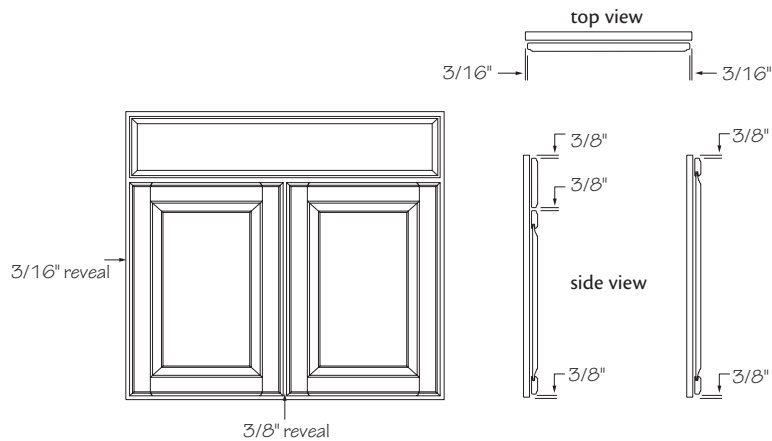

- Full Overlay doors leave $3/16$ " of the cabinet's face frame exposed on either side of the doors and $3/8$ " exposed between doors
- Butt door cabinets have $1/8$ " reveal between doors
- Nickel-finished self-closing hinges, adjustable six ways for door alignment
- The reveals shown here may vary slightly on some cabinets due to actual door/drawer front sizes used

Traditional Overlay - Concealed Hinges

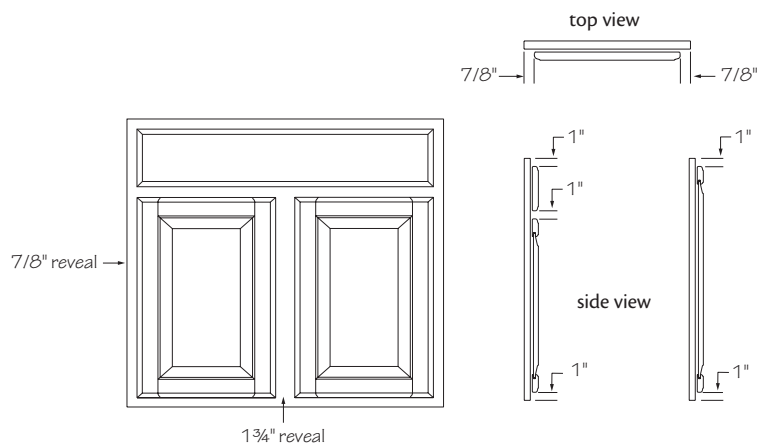

- Traditional Overlay doors leave $7/8$ " of the cabinet's face frame exposed on either side of the doors and $1\ 3/4$ " exposed between doors
- Butt door cabinets have $1/8$ " reveal between doors
- Nickel-finished self-closing hinges, adjustable six ways for door alignment
- The reveals shown here may vary slightly on some cabinets due to actual door/drawer front sizes used

Construction Options

Construction Options and Modifications

- ❖ Included as standard
- Available with an upcharge
- ☆ Available with exceptions

(Blank) **Not** available

Depending on the door style selected, all Merillat Cabinetry cabinet frames shall be constructed of solid hardwood matched to the door and drawer front specifications.



SST	Construction	-----	(7)
SDT	Construction	-----	(7)
HDS	Half Depth Shelf	-----	(10d)
FDS	Full Depth Shelf	-----	(10d)
1ST	1 Standard Tray	-----	(10d)
2ST	2 Standard Trays	-----	(10d)
4ST	4 Standard Trays	-----	(10d)
1FT	1 Standard Full-Width Tray	--	(10d)
2FT	2 Standard Full-Width Trays	--	(10d)
CFO	Cabinet Front Only	-----	(10g)
CSO	Case Only	-----	(10g)

Cabinet Construction

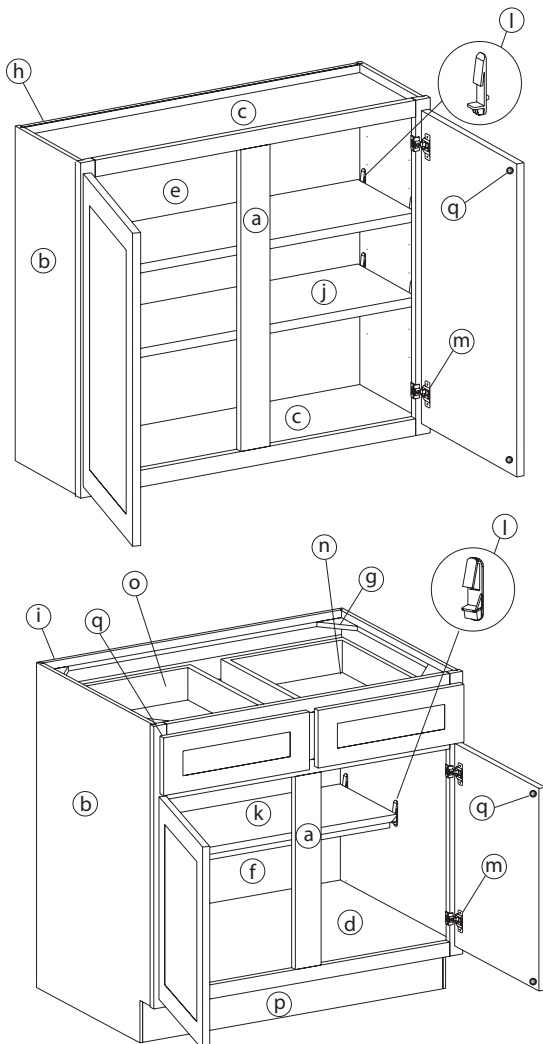

- a. Face Frame
- b. End Panels
- c. Wall and Tall Tops and Bottoms
- d. Base and Vanity Bottoms
- e. Wall Backs
- f. Tall, Base and Vanity Backs
- g. Base Corner Gussets
- h. Wall and Tall Hang Rail
- i. Base and Vanity Screw Rail
- j. Wall and Tall Shelves
- k. Base Shelves
- l. Shelf Supports
- m. Hinges
- n. Drawer Guides
- o. Drawer Core
- p. Toeboard Backer
- q. Door and Drawer Bumpers

Construction Options Chart

	Standard Construction (SST)	Details (SST)	Standard Construction with Dovetail Drawers (SDT)	Details (SDT)
Face Frame	Solid Hardwood			
Wall, Base and Vanity End Panels	3/8" Engineered Wood	Ext. Finish: laminate to match frame Int. Finish: natural wood grain laminate	3/8" Engineered Wood	Ext. Finish: laminate to match frame Int. Finish: natural wood grain laminate
Tall End Panels	1/2" Engineered Wood		1/2" Engineered Wood	
Wall and Tall Tops and Bottoms	1/2" Engineered Wood	Ext. Finish: natural wood grain laminate Int. Finish: natural wood grain laminate	1/2" Engineered Wood	Ext. Finish: natural wood grain laminate Int. Finish: natural wood grain laminate
Base and Vanity Bottoms		Ext. Finish: unfinished Int. Finish: natural wood grain laminate		Ext. Finish: unfinished Int. Finish: natural wood grain laminate
Wall Backs	3/8" Engineered Wood		3/8" Engineered Wood	
Base and Vanity Backs	1/4" Engineered Wood	Ext. Finish: unfinished Int. Finish: natural wood grain laminate	1/4" Engineered Wood	Ext. Finish: unfinished Int. Finish: natural wood grain laminate
Tall Backs	1/4" Engineered Wood		1/4" Engineered Wood	
Base Corner Gussets	1/2" Engineered Wood Dadoed and glued to cabinet corners			
Shelves	3/4" Engineered Wood w/ Clear Polycarbonate Shelf Supports	15lbs per sq. ft load capacity	3/4" Engineered Wood w/ Clear Polycarbonate Shelf Supports	15lbs per sq. ft load capacity
Hinges	Nickel Plated, concealed self-closing			
Drawer Guides	3/4 extension side-mount drawer slide system	75 lb load capacity	Full extension, concealed, undermount slide system with SoftAction+	75 lb load capacity
Drawer Core/ Drawer Bottom	Core: 1/2" Engineered Wood Bottom: 1/4" Engineered Wood	Drawers 30" and wider have 3/8" bottoms	Core: 5/8" Solid Hardwood Bottom: 3/16" 3-ply Plywood	Drawers 30" and wider have 3/8" solid hardwood cleat for extra support
Toeboard Backer	3/8" Engineered Wood Toespace - 4 1/2" tall (Universal is 5 1/2" tall) x 2 25/32" Deep			
Roll-Out Trays	1/2" Engineered or Solid Wood			

Construction Options Diagram

Standard Construction (SST)

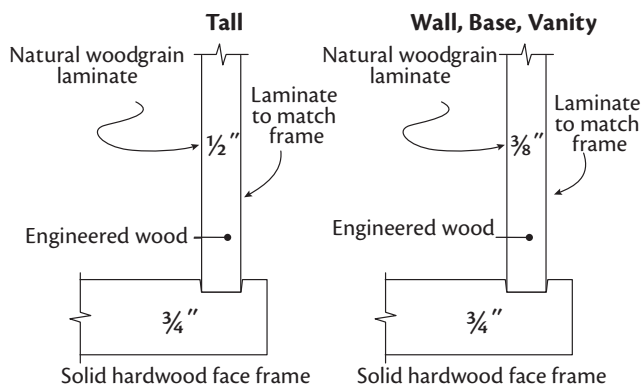

1/2" Engineered wood (SST)

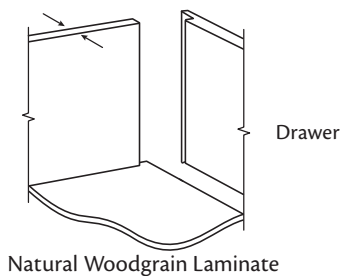

Standard Construction with Dovetail Drawers (SDT)

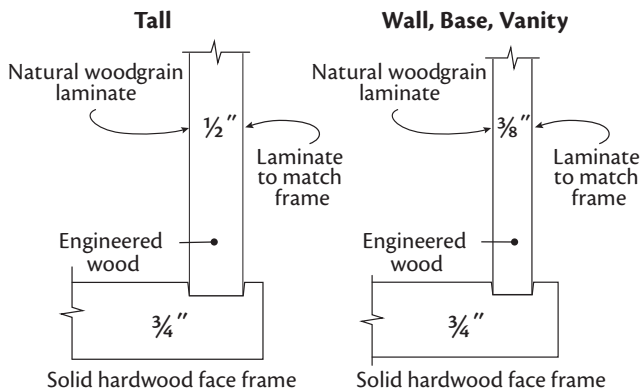

5/8" Solid Hardwood

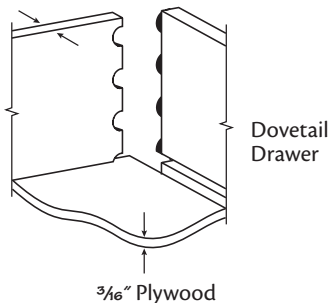

Half Depth Shelf

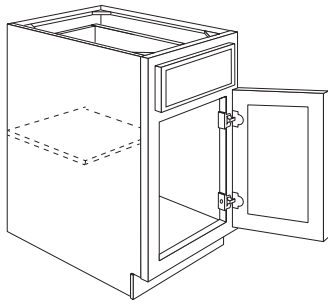

⑩d
HDS

- 3/4" thick engineered wood
- Standard shelf for most Base and Universal cabinets
- Cabinets 39" or wider will have full length support cleat attached to the underside of the shelf along the front edge

◆ **HDS** ⑩d

Full Depth Shelf

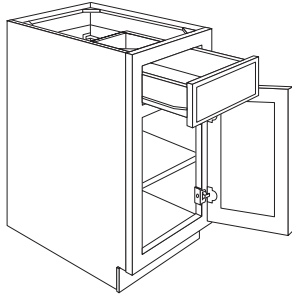

⑩d
FDS

- 3/4" thick engineered wood
- Available for most Base cabinets
- **Note:** When selected, replace HDS (10d) with FDS

● **FDS** ⑩d

1 Standard Tray

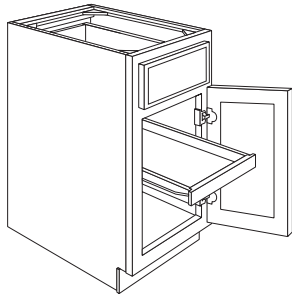

⑩d
1ST

- Standard trays sides and back are 1/2" thick engineered wood with 1/4" thick engineered wood bottom, natural woodgrain laminate. Fronts are 3/4" thick solid hardwood
- Available for most Base cabinets
- Natural woodgrain laminate
- 3/4 extension side mount glide
- 75 lbs. capacity
- Shelves are omitted from cabinets when roll-out tray options are selected

● **1ST** ⑩d

2 Standard Trays

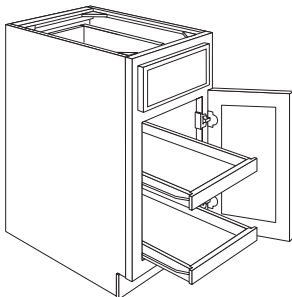

⑩d
2ST

- Standard trays sides and back are 1/2" thick engineered wood with 1/4" thick engineered wood bottom, natural woodgrain laminate. Fronts are 3/4" thick solid hardwood
- Available for most Base cabinets
- Natural woodgrain laminate
- 3/4 extension side mount glide
- 75 lbs. capacity
- Shelves are omitted from cabinets when roll-out tray options are selected

● **2ST** ⑩d

4 Standard Trays

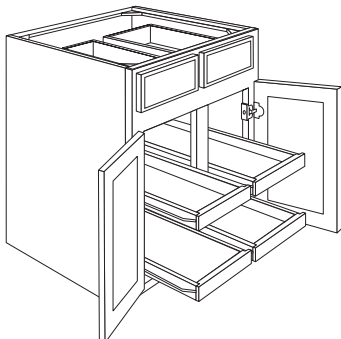

⑩d
4ST

- Standard trays sides and back are 1/2" thick engineered wood with 1/4" thick engineered wood bottom, natural woodgrain laminate. Fronts are 3/4" thick solid hardwood
- Available for most 2 door Base cabinets
- 3/4 extension side mount glide
- 75 lbs. capacity
- Shelves are omitted from cabinets when roll-out tray options are selected

● **4ST** ⑩d

1 Standard Full-Width Tray

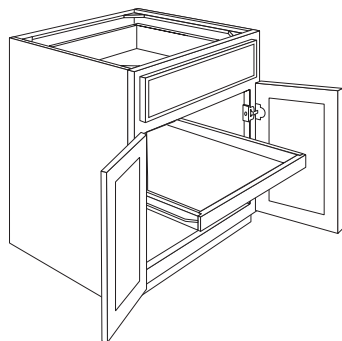

⑩d
1FT

- Standard tray spans the full-width of cabinet
- Standard trays sides and back are 1/2" thick engineered wood with 1/4" thick engineered wood bottom, natural woodgrain laminate. Fronts are 3/4" thick solid hardwood
- 3/4 extension side mount glide
- 75 lbs. capacity
- Available for most Base Butt Door cabinets
- Shelves are omitted from cabinets when roll-out tray options are selected

● 1FT ⑩d

2 Standard Full-Width Trays

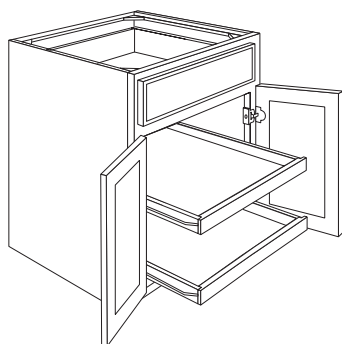

⑩d
2FT

- Standard tray spans the full-width of cabinet
- Standard trays sides and back are 1/2" thick engineered wood with 1/4" thick engineered wood bottom, natural woodgrain laminate. Fronts are 3/4" thick solid hardwood
- 3/4 extension side mount glide
- 75 lbs. capacity
- Available for most Base Butt Door cabinets
- Shelves are omitted from cabinets when roll-out tray options are selected

● 2FT ⑩d

Cabinet Front Only

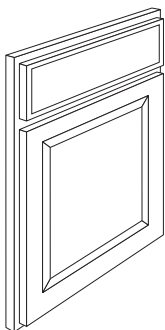

⑩g
CFO

- Front frame and appropriate doors and drawer fronts only
- Does **not** include toe kick

● CFO ⑩g

New

Case Only Option

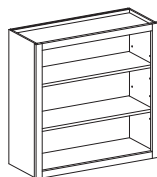

⑩g
CSO

Grey color coding indicates new product, size or code.

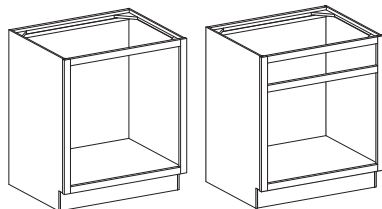

- For Case Only option on Walls: Includes shelves, if applicable. Interior and shelves are natural woodgrain. No doors or hinges
- For Case Only (CSO) option on Base, Base Drawer, Vanity, Vanity Drawer, and Tall: Includes cabinet box only. Does **not** include doors, drawer fronts, drawer cores, hinges, shelves, trays and slides
- Available on most cabinets, see individual models for exceptions
- Cabinets with revolving shelves will ship with revolving shelves; Base Corner Fixed Shelf (BCF536) will ship with fixed shelf

● CSO ⑩g

Wall Cabinets

Construction Options and Modifications

- ❖ Included as standard
- Available with an upcharge
- ☆ Available with exceptions

(Blank) **Not** available

SST Construction	-----	⑦
SDT Construction	-----	⑦
CFO Cabinet Front Only	-----	⑩g
CSO Case Only	-----	⑩g

Note: Standard wall cabinet box depth is 12" unless stated otherwise. Add door thickness with bumpers for total depth.

Caution: Installation of a wall cabinet 30" or wider requires additional support, such as attachment to a soffit, or support from below. Failure to provide additional support could result in collapse of the cabinet, serious personal injury, or property damage. Damage relating to failure to provide additional support is **not** covered by the limited warranty. See inside cover for warranty details

Any wall cabinet over 24" wide or 30" high with a depth greater than 12" and/or butt doors **must** be installed between two cabinets, a cabinet and a wall, or supported from below.

Material dimensions may vary slightly based on lumber industry standards.

Specifications subject to change without notice.

⑩a ⑩c ⑩g
W1830 **L** **CFO**

Wall Single Door

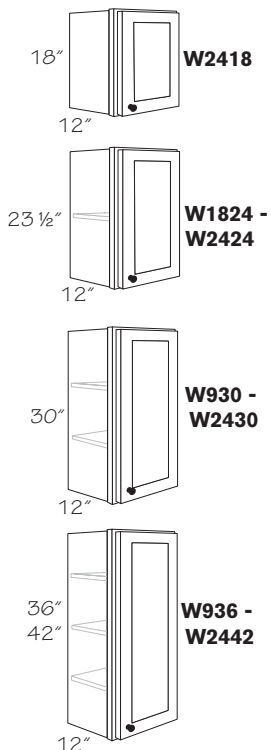

⑩a	⑩c	⑩a	⑩c
<i>Specify R or L</i>		<i>Specify R or L</i>	
18" High		36" High	
W2418	R or L	W936	R or L
<i>23 1/2" High</i>		<i>42" High</i>	
W1824	R or L	W1236	R or L
W2124	R or L	W1536	R or L
W2424	R or L	W1836	R or L
<i>30" High</i>		W2136	R or L
W930	R or L	W2436	R or L
W1230	R or L	W942	R or L
W1530	R or L	W1242	R or L
W1830	R or L	W1542	R or L
W2130	R or L	W1842	R or L
W2430	R or L	W2142	R or L
		W2442	R or L

- 18" high cabinets have no shelves
- 23 1/2" high cabinets have one adjustable shelf
- 30" high cabinets have two adjustable shelves
- 36" - 42" high cabinets have three adjustable shelves

❖	SST	⑦
❖	SDT	⑦
●	CFO	⑩g
●	CSO	⑩g

Wall Double Door

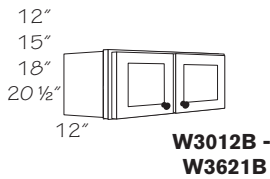

⑩a

12" High
W3012B
W3612B
W3912

⑩a

30" High
W2430B
W2730B
W3030B
W3330B
W3630B
W3930
W4230
W4530
W4830

- 12" - 20 1/2" high cabinets have no shelves
- 23 1/2" and 27" high cabinets have one adjustable shelf
- 30" high cabinets have two adjustable shelves
- 36" - 42" high cabinets have three adjustable shelves
- Cabinets with a "B" suffix have BUTT doors without a center stile

❖ SST ⑦
❖ SDT ⑦
● CFO ⑩g
● CSO ⑩g

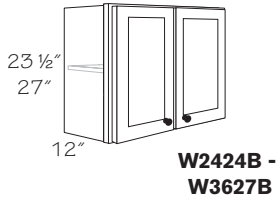

15" High
W3015B
W3315B
W3615B
18" High
W3018B
W3318B
W3618B
W3918

36" High
W2436B
W2736B
W3036B
W3336B
W3636B
W3936
W4236

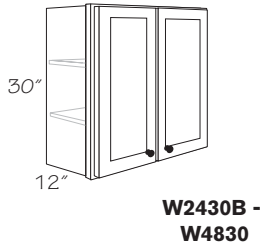

20 1/2" High
W3021B
W3621B
23 1/2" High
W2424B
W3024B
W3324B
W3624B
W3924
W4224

42" High
W2442B
W2742B
W3042B
W3342B
W3642B
W3942
W4242

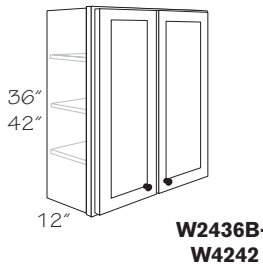

Wall Refrigerator

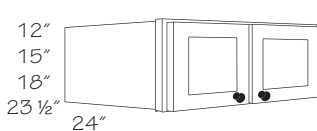

⑩a

12" High
WR3012B
WR3612B
WR3912
15" High
WR3315B
WR3615B

⑩a

18" High
WR3018B
WR3318B
WR3618B
WR3918
23 1/2" High
WR3624B
WR3924

- Designed for use over refrigerators where there is adequate clearance
- No shelves
- Cabinets with a "B" suffix have BUTT doors without a center stile

❖ SST ⑦
❖ SDT ⑦
● CFO ⑩g
● CSO ⑩g

Caution: Additional support is required. See installation sheet provided with cabinet or the Merillat Framed Cabinet Installation Guide

Peninsula Wall Single Door

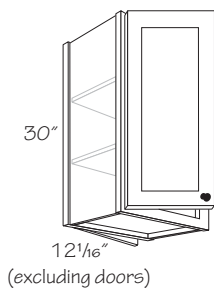

⑩a

30" High
PW1830
PW2130
PW2430

- Two adjustable shelves
- Reversible for left or right hinging
- Each side has one door hinged at the same end of cabinet

❖ SST ⑦
❖ SDT ⑦
● CFO ⑩g
● CSO ⑩g

Caution: Peninsula Wall Cabinets *must* be installed against a soffit, ceiling or supported by a countertop. See Cabinet installation guide for specific instructions

Peninsula Wall Double Door

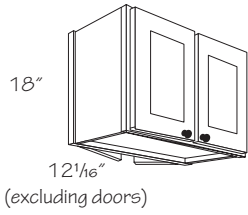

PW3018B - PW3618B

10a

18" High
PW3018B
PW3618B
 23 1/2" High
PW3024B
PW3624B
 30" High
PW2430B
PW3030B
PW3630B

- 18" high cabinets have no shelves
- 23 1/2" high cabinets have one adjustable shelf
- 30" high cabinets have two adjustable shelves
- Cabinets have BUTT doors without a center frame stile
- Each side has two doors

- ❖ SST 7
- ❖ SDT 7
- CFO 10g
- CSO 10g

! Peninsula Wall Cabinets *must* be installed against a soffit, ceiling or supported by a countertop. See Cabinet installation guide for specific instructions

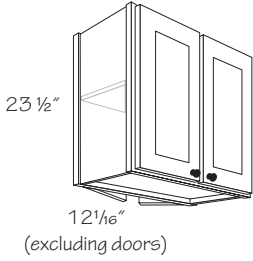

PW3024B - PW3624B

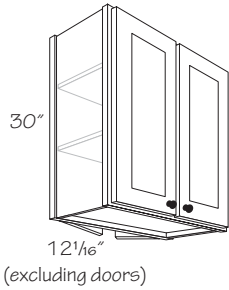

PW2430B - PW3630B

Wall Corner Cabinets

- SST Construction ----- (7)
- SDT Construction ----- (7)
- CFO Cabinet Front Only----- (10g)
- CSO Case Only----- (10g)

Construction Options and Modifications

- ❖ Included as standard
 - Available with an upcharge
 - ☆ Available with exceptions
- (Blank) **Not** available

10a

WBC30/3330BR

Wall Blind Corner Cabinet Information

- Wall blind corner cabinets provide access to corner space and permits adjustability of up to 2 7/8" maximum to aid in kitchen cabinet layout. Consult chart for "pull" dimensions and minimum wall space requirements.
- "Pulling" the cabinet away from the corner (2 7/8" maximum), and using the supplied filler and panel provides clearance for opening doors when decorative hardware is used.
- BR or BL indicates blind end of cabinet. Please specify.
- Door hinged on same side as blind
- Cabinets may be changed from right to left by inverting cabinet.
- **Note:** A 3" Wall Filler and Blind Panel is included with each WBC cabinet ordered, shipped unattached.

Wall Blind Corner	Partial Overlay						Full Overlay					
	(A) Wall Space		(B) Cabinet Width	(C) Frame Opening	(D) Door Hardware Clearance		(A) Wall Space		(B) Cabinet Width	(C) Frame Opening	(D) Door Hardware Clearance	
	No Pull	Max Pull			No Pull	Max Pull	No Pull	Max Pull			No Pull	Max Pull
WBC30/33	30"	32 7/8"	30"	13 1/2"	1 5/8"	4 1/2"	30"	32 7/8"	30"	13 1/2"	1 3/16"	3 11/16"
WBC36/39	36"	38 7/8"	36"	19 1/2"	1 5/8"	4 1/2"	36"	38 7/8"	36"	19 1/2"	1 3/16"	3 11/16"
WBC48/51	48"	50 7/8"	48"	13 1/2", 15"	1 5/8"	4 1/2"	48"	50 7/8"	48"	13 1/2", 15"	1 3/16"	3 11/16"

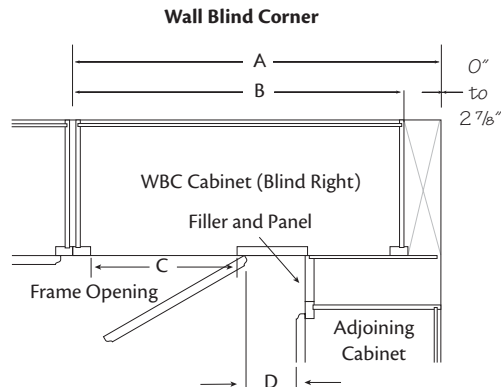
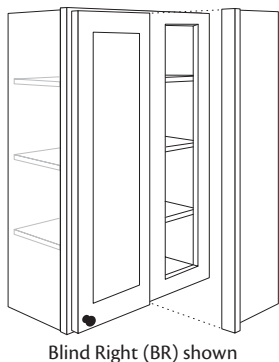

Wall Blind Corner Single Door

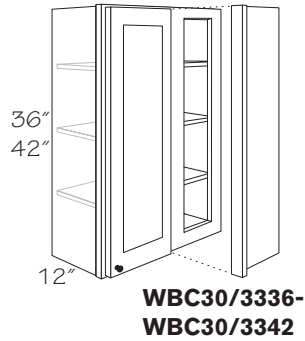
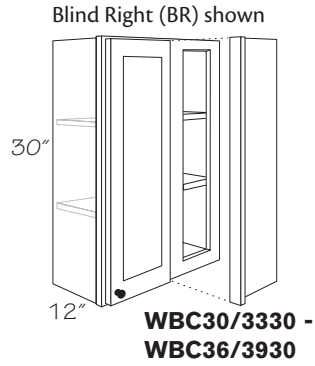

⑩a

Specify BR or BL
30" High

WBC30/3330 BR or BL

WBC36/3930 BR or BL

36" High

WBC30/3336 BR or BL

42" High

WBC30/3342 BR or BL

- 30" high cabinets have two adjustable shelves
- 36" - 42" high cabinets have three adjustable shelves
- Door hinged to center stile
- Do **not** pull cabinet more than 2 7/8" from corner
- Blind Panel with 3" filler included, shipped unattached

❖ SST ⑦

❖ SDT ⑦

● CFO ⑩g

● CSO ⑩g

Wall Blind Corner Double Door

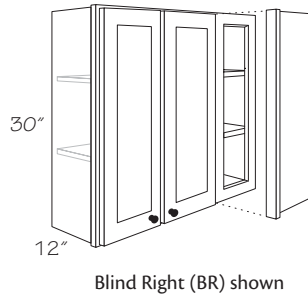

⑩a

Specify BR or BL

WBC48/5130 BR or BL

- Two adjustable shelves
- Two different width doors; the narrower is located next to the blind panel
- Do **not** pull cabinet more than 2 7/8" from corner
- Blind Panel with 3" filler included, shipped unattached

❖ SST ⑦

❖ SDT ⑦

● CFO ⑩g

● CSO ⑩g

Wall Angle Single Door

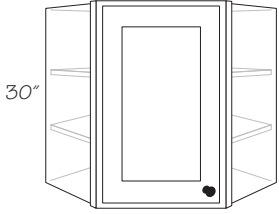

30"

WA2430-WA2730

⑩a ⑩c

Specify R or L
 30" High
WA2430 R or L
WA2730 R or L
 36" High
WA2436 R or L
WA2736 R or L
 42" High
WA2442 R or L
WA2742 R or L

- 30" high cabinets have two adjustable shelves
- 36" - 42" high cabinets have three adjustable shelves
- Back corner removed for easy installation
- Full and Traditional overlay door widths are similar to avoid interference with adjacent cabinet doors
- Adjacent cabinets can be installed directly without fillers

- ❖ SST ⑦
- ❖ SDT ⑦
- CFO ⑩g
- CSO ⑩g

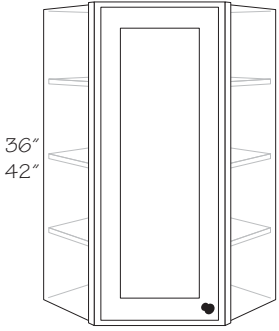

36"
42"

WA2436 - WA2742

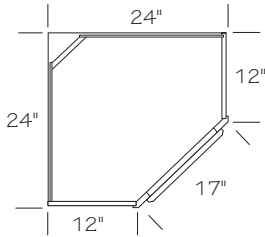

WA24__

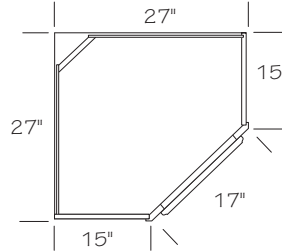

WA27__

Peninsula Wall Angle

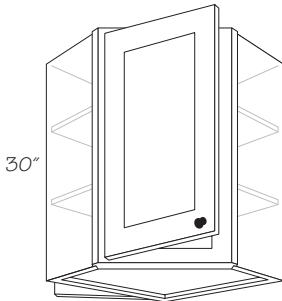

30"

Left Hand shown

⑩a ⑩c

Specify R or L
PWA2430 R or L

- Two adjustable shelves
- R or L designates dining room side door hinging
- Stile on dining room frame is extra wide to clear window or door molding
- Full and Traditional overlay door widths are similar to avoid interference with adjacent cabinet doors
- Adjacent cabinets can be installed directly without fillers
- Requires 24 1/16" of wall space excluding dining room side cabinet door

- ❖ SST ⑦
- ❖ SDT ⑦
- CFO ⑩g
- CSO ⑩g

! Peninsula Wall Cabinets **must** be installed against a soffit, ceiling or supported by a countertop. See Cabinet installation guide for specific instructions

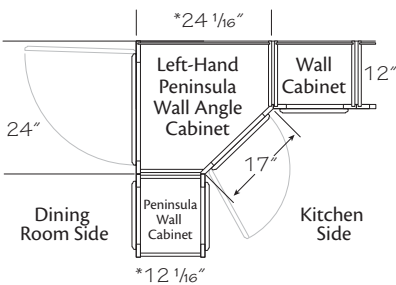

Left Hand shown

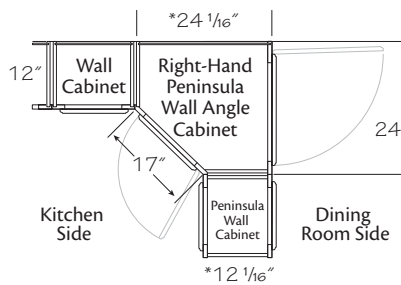

Right Hand shown

*Dimension excludes doors

Wall Corner Angle

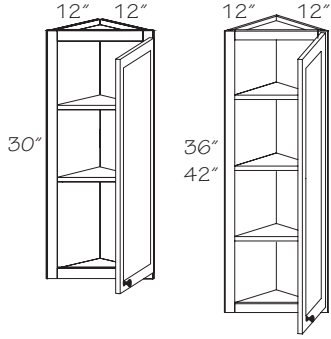

WCA1230

**WCA1236-
WCA1242**

10a

10c

Specify R or L
30" High

WCA1230 R or L

36" High

WCA1236 R or L

42" High

WCA1242 R or L

- For use at end of cabinet run or in a corner
- 30" high cabinets have two adjustable shelves
- 36" - 42" high cabinets have three adjustable shelves

❖ SST 7

❖ SDT 7

● CFO 10g

● CSO 10g

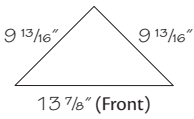

Plan View of Adjustable Shelf

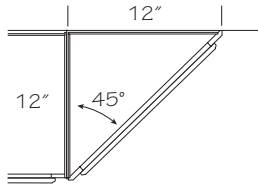

Wall Open Cabinets

Construction Options and Modifications

SST Construction ----- (7)
 SDT Construction ----- (7)

- ❖ Included as standard
 - Available with an upcharge
 - ☆ Available with exceptions
- (Blank) **Not** available

Caution: Bookcases are typically subjected to extreme weight. Additional support is required. Wall hung applications **must** be limited to 15 lbs. per square foot of shelf area; **not** to exceed 50 lbs. per shelf.

Specifications subject to change without notice.

(10a)

BK1830

Bookcase Cabinets

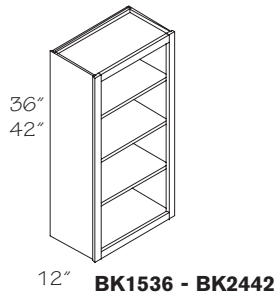
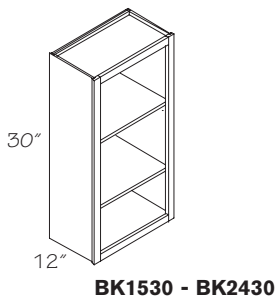

(10a)

30" High
BK1530
BK1830
BK2130
BK2430

36" High
BK1536
BK1836
BK2136
BK2436

42" High
BK1542
BK1842
BK2142
BK2442

- 30" high bookcases have two adjustable shelves ❖ SST (7)
- 36" and 42" high bookcases have three adjustable shelves ❖ SDT (7)
- Matching laminate interior
- Maple Accent Glaze shipped standard finish
- Vertical wood grain back panel; except for painted finishes
- Includes low profile clear polycarbonate shelf supports in addition to hold-down style supports used for shipping

Wall Lattice

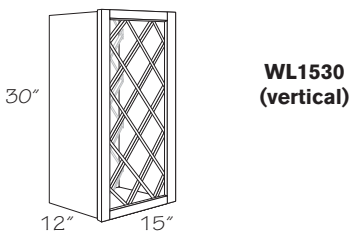
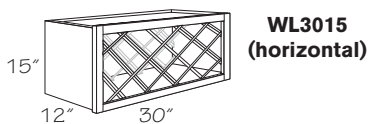

(10a)

15" High
WL3015 11 Bottles
 30" High
WL1530 11 Bottles

- Matching laminate interior ❖ SST (7)
- Vertical wood grain back panel; except for painted finishes ❖ SDT (7)
- Lattices are finished to match
- Lattice in painted finishes are painted hardwood
- Lattices are **not** removable
- 4" x 4" bottle openings

Wall Appliance Cabinets

SST Construction ----- (7)

SDT Construction ----- (7)

Construction Options and Modifications

- ❖ Included as standard
- Available with an upcharge
- ☆ Available with exceptions

(Blank) **Not** available

(10a)

WMS271812

Wall Microwave Shelf

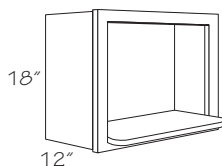

(10a)

WMS271812
WMS301812

- ❖ SST (7) 3/4" thick shelf extends 3 25/32" beyond face frame of cabinet
- ❖ SDT (7) Shelf shipped unattached for easier installation; mounting hardware included
- Vertical wood grain back panel; except for painted finishes
- Designed for countertop style microwaves
- Matching laminate interior
- Available in all finishes; Maple Accent Glaze shipped standard finish
- Painted glazes are shipped as standard finish
- **Note: Must** be installed between two cabinets or between cabinet and side wall

Cabinet	Opening Sizes
WMS271812	24" wide x 14 1/4" high x 15" deep (shelf)
WMS301812	27" wide x 14 1/4" high x 15" deep (shelf)

Wall Accessories

HW	Hardwood	-----	(2)
MP	Maple	-----	(2)
RO	Red Oak	-----	(2)
TH	Thermofoil	-----	(2)

Construction Options and Modifications

- ❖ Included as standard
 - Available with an upcharge
 - ☆ Available with exceptions
- (Blank) **Not** available

(10a)

MWEP1230

Lazy Susan Revolving Shelf Kit (One Shelf)

(10a)

LS1

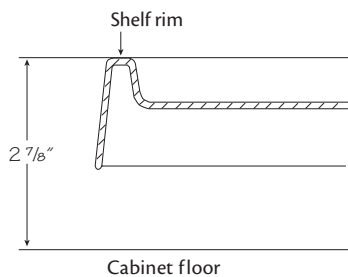
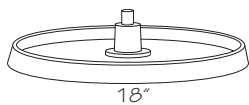

- One 18" diameter wide impact white plastic shelf
- Distance from top of shelf rim to top of cabinet surface is 2 7/8"
- Attaches to cabinet shelf or bottom, 1 1/2" clearance gap between bottom of shelf and cabinet bottom
- Installation instructions and mounting hardware included
- Fits 30", 36" and 42" high Wall Angle (WA) and Peninsula Wall Angle (PWA) cabinets
- One per carton

HW	(2)
MP	(2)
RO	(2)
TH	(2)

Lazy Susan Revolving Shelf Kit (Three Shelves)

(10a)

LS3

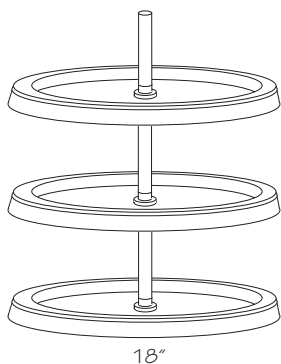

- Three 18" diameter wide impact white plastic shelves that rotate together
- Fits 24" wide Wall Angle (WA) and Peninsula Wall Angle (PWA) cabinets
- Replaces adjustable shelves shipped with cabinet
- Includes center post and installation hardware
- Adjust 22" to 33" in height
- One set of three shelves per carton

HW	(2)
MP	(2)
RO	(2)
TH	(2)

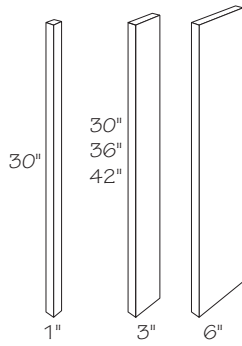

Wall Filler

- ⑩a
 1" Wide
WF1-30
 3" Wide
WF3-30
WF3-30-4
WF3-36
WF3-42
WF3-42-4
- ⑩a
 6" Wide
WF6-30
WF6-36
WF6-42

- 3/4" thick solid wood
- Backside of filler **not** finished
- Available in all finishes; Maple Accent Glaze shipped standard finish
- Available in all painted finishes, which are painted hardwood
- Offered individually; select models offered in quantities of 4

- ❖ HW ②
- ❖ MP ②
- ❖ RO ②
- ❖ TH ②

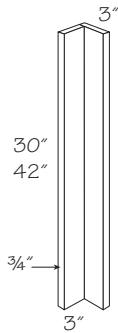

Wall Filler Corner

- ⑩a
WFC3-30
WFC3-42

- 3" on each face
- 3/4" thick solid wood
- Available in all finishes; Maple Accent Glaze shipped standard finish
- Available in all painted finishes, which are painted hardwood
- Backside of filler **not** finished
- One per carton

- ❖ HW ②
- ❖ MP ②
- ❖ RO ②
- ❖ TH ②

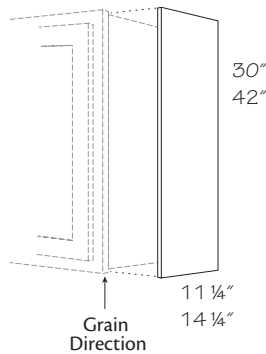

Wall End Panel

- ⑩a
 11 1/4" Wide
WEP30
WEP42
 14 1/4" Wide
WEP1530
WEP1542

- Used to trim exposed end of wall cabinet
- For right or left hand use
- 5/32" thick veneered plywood panel, except White, finished on one side; grain runs lengthwise
- 3/16" thick laminate panel for White; finished on one side only
- 42" panels trimmable for 36" wall cabinets
- Finished one side only
- Available in all finishes; Maple Accent Glaze shipped standard finish
- Available in all painted finishes, which are painted veneer
- One per carton

- ❖ HW ②
- ❖ MP ②
- ❖ RO ②
- ❖ TH ②

Matching Wall End Panel

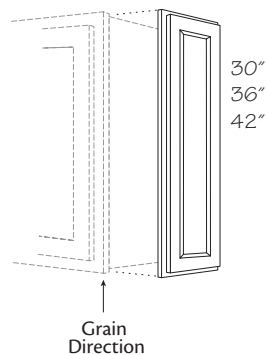

- ⑩a
 11 1/4" Wide
MWEP1230
MWEP1236
MWEP1242

- Provides a finished furniture look to 12" deep wall cabinet ends
- For right or left hand use
- 3/16" thick white laminate panel for Arbor Falls Express
- 5/32" thick veneered plywood panel, except Arbor Falls Express
- Available in all door styles and finishes
- Door shipped attached to panel
- One per carton

- ❖ HW ②
- ❖ MP ②
- ❖ RO ②
- ❖ TH ②

Item	Panel Size		Full Overlay Door		Traditional Overlay Door	
	Width	Length	Width	Length	Width	Length
MWEP1230	11 1/4"	30"	11 5/8"	29 1/4"	10 1/4"	28"
MWEP1236	11 1/4"	36"	11 5/8"	35 1/4"	10 1/4"	34"
MWEP1242	11 1/4"	42"	11 5/8"	41 1/4"	10 1/4"	40"

Notes

Base Cabinets

Construction Options and Modifications

- ❖ Included as standard
- Available with an upcharge
- ☆ Available with exceptions

(Blank) **Not** available

SST	Construction	-----	(7)
SDT	Construction	-----	(7)
HDS	Half Depth Shelf	-----	(10d)
FDS	Full Depth Shelf	-----	(10d)
1ST	1 Standard Tray	-----	(10d)
2ST	2 Standard Trays	-----	(10d)
4ST	4 Standard Trays	-----	(10d)
1FT	1 Standard Full-Width Tray	-----	(10d)
2FT	2 Standard Full-Width Trays	-----	(10d)
CFO	Cabinet Front Only	-----	(10g)
CSO	Case Only	-----	(10g)



Base Single Door

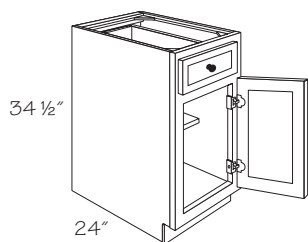

HDS option shown



Specify R or L

B12	R or L	HDS
B15	R or L	HDS
B18	R or L	HDS
B21	R or L	HDS
B24	R or L	HDS

- Standard height top drawer
- Back panel is pre-drilled for optional accessory Tray Kits
- **Note:** For tray or shelf options for select cabinets, replace HDS (10d) with the option code of your choice

❖ SST (7)	4ST (10d)
● SDT (7)	1FT (10d)
❖ HDS (10d)	2FT (10d)
● FDS (10d)	● CFO (10g)
● 1ST (10d)	● CSO (10g)
● 2ST (10d)	

Base Single Door Full-Height

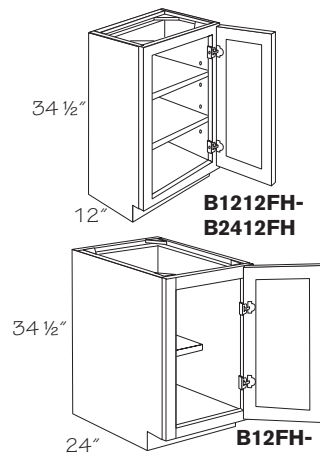

HDS option shown



12" Deep
Specify R or L

▲	B1212FH	R or L	
▲	B1512FH	R or L	
▲	B1812FH	R or L	
▲	B2112FH	R or L	
▲	B2412FH	R or L	

24" Deep

▲	B9FH	R or L	
	B12FH	R or L	HDS
	B15FH	R or L	HDS
	B18FH	R or L	HDS
	B21FH	R or L	HDS
	B24FH	R or L	HDS

▲ **Not** available with tray or shelf options

- B9FH has no shelf
- Back panel is pre-drilled for optional accessory Tray Kits
- **Note:** For tray or shelf options for select cabinets, replace HDS (10d) with the option code of your choice

❖ SST (7)	4ST (10d)
❖ SDT (7)	1FT (10d)
● HDS (10d)	2FT (10d)
● FDS (10d)	● CFO (10g)
● 1ST (10d)	● CSO (10g)
● 2ST (10d)	

Base Double Door

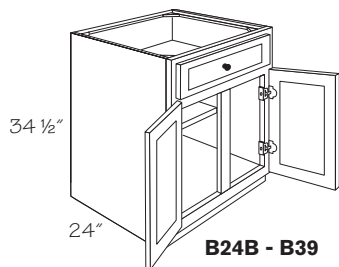

Non-Butt, HDS option shown

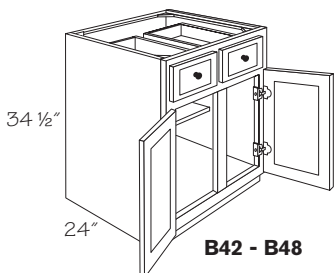

HDS option shown

⑩a ⑩d

One Drawer

B24B HDS
B27B HDS
B30B HDS
B33B HDS
B36B HDS
B39 HDS

Two Drawers

B42 HDS
B45 HDS
B48 HDS

- Standard height top drawers
- B24B-B39 have one standard drawer
- B42-B48 have two standard drawers
- Back panel is pre-drilled for optional accessory Tray Kits
- Cabinets with a "B" suffix have BUTT doors without a center stile
- Note:** For tray or shelf options for select cabinets, replace HDS (10d) with the option code of your choice

❖ SST ⑦	● 4ST ⑩d
● SDT ⑦	● 1FT ⑩d
❖ HDS ⑩d	● 2FT ⑩d
● FDS ⑩d	● CFO ⑩g
1ST ⑩d	● CSO ⑩g
● 2ST ⑩d	

Base Double Door Full-Height

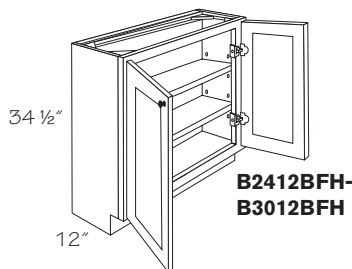

B2412BFH-
B3012BFH

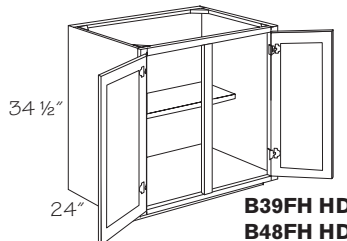

B39FH HDS-
B48FH HDS

Non-butt, HDS option shown

⑩a ⑩d

12" Deep

▲ **B2412BFH**
 ▲ **B2712BFH**
 ▲ **B3012BFH**

24" Deep

B24BFH HDS
B27BFH HDS
B30BFH HDS
B33BFH HDS
B36BFH HDS
B39FH HDS
B42FH HDS
B45FH HDS
B48FH HDS

▲ **Not available with tray or shelf options**

- Cabinets with a "B" suffix have BUTT doors without a center stile
- Back panel is pre-drilled for optional accessory Tray Kits
- Note:** For tray or shelf options for select cabinets, replace HDS (10d) with the option code of your choice

❖ SST ⑦	● 4ST ⑩d
❖ SDT ⑦	● 1FT ⑩d
❖ HDS ⑩d	● 2FT ⑩d
● FDS ⑩d	● CFO ⑩g
1ST ⑩d	● CSO ⑩g
● 2ST ⑩d	

Peninsula Base Single Door

Peninsula side

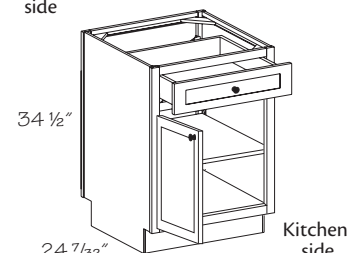

FDS option shown

⑩a ⑩d

PB18 FDS
PB21 FDS
PB24 FDS

Peninsula side

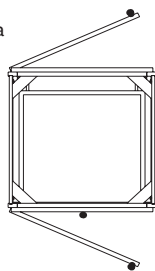

Kitchen side

- One standard height full-width drawer opens on kitchen side
- Peninsula side has one full-width false drawer front above door
- Each side has one door hinged at the same end of cabinet
- Door hinged left on kitchen side
- Note:** Full depth shelf (FDS) option or a tray option **must** be selected for this cabinet
- Note:** Because these cabinets do **not** have back panels, it is **not** recommended to use Peninsula Base cabinets (PB) in island applications. Failure to follow this limitation could cause serious injury and will void the product warranty

❖ SST ⑦	● 4ST ⑩d
● SDT ⑦	● 1FT ⑩d
HDS ⑩d	● 2FT ⑩d
● FDS ⑩d	● CFO ⑩g
● 1ST ⑩d	● CSO ⑩g
● 2ST ⑩d	

Peninsula Base Butt Door

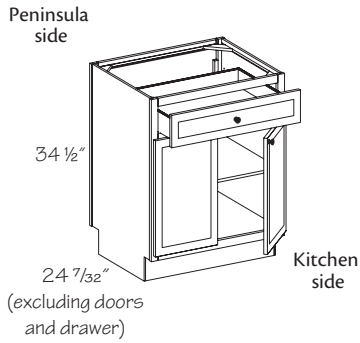

- ⑩a
- PB24B FDS**
- PB27B FDS**
- PB30B FDS**
- PB36B FDS**
- ⑩d

- One standard height full-width drawer opens on kitchen side
- Peninsula side has one full-width false drawer front above doors
- Each side has two doors
- Cabinets have BUTT doors without a center frame stile
- **Note:** Full depth shelf (FDS) option or a tray option **must** be selected for this cabinet
- **Note:** Because these cabinets do **not** have back panels, it is **not** recommended to use Peninsula Base cabinets (PB) in island applications. Failure to follow this limitation could cause serious injury and will void the product warranty

❖ SST ⑦	4ST ⑩d
● SDT ⑦	● 1FT ⑩d
HDS ⑩d	● 2FT ⑩d
● FDS ⑩d	● CFO ⑩g
1ST ⑩d	● CSO ⑩g
2ST ⑩d	

Base Three Drawer

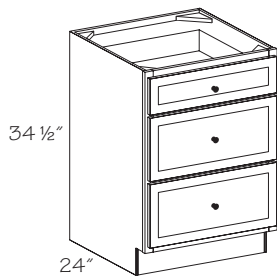

- ⑩a
- 3/4 Extension Drawer*
- BD12-3D**
- BD15-3D**
- BD18-3D**
- BD21-3D**
- BD24-3D**
- BD27-3D**
- Full Extension Drawer*
- BD30-3D**
- BD33-3D**
- BD36-3D**

- One standard height drawer on top
- Two deep drawers on bottom
- Cabinets BD12-3D to BD27-3D in SST construction will have standard 3/4 extension side mount slides on all three drawers. SDT construction will have full extension undermount soft-close slides on all three drawers
- Cabinets BD30-3D to BD36-3D in SST construction will have standard 3/4 extension side mount slides on top drawer and full extension ball bearing side mount slides on deep drawers. SDT construction will have full extension undermount soft-close slides on all three drawers

❖ SST ⑦	4ST ⑩d
● SDT ⑦	1FT ⑩d
HDS ⑩d	2FT ⑩d
FDS ⑩d	● CFO ⑩g
1ST ⑩d	● CSO ⑩g
2ST ⑩d	

Base Four Drawer

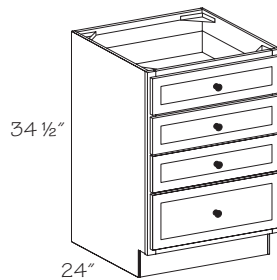

- ⑩a
- BD12-4D**
- BD15-4D**
- BD18-4D**
- BD21-4D**
- BD24-4D**

- Three standard height drawers
- One deep drawer on bottom
- 3/4 extension slides on all drawers when SST construction is chosen

❖ SST ⑦	4ST ⑩d
● SDT ⑦	1FT ⑩d
HDS ⑩d	2FT ⑩d
FDS ⑩d	● CFO ⑩g
1ST ⑩d	● CSO ⑩g
2ST ⑩d	

Base Wastebasket Top Mount

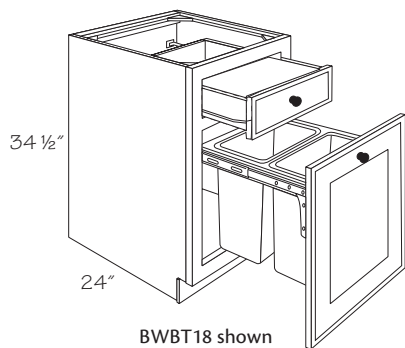

- ⑩a
- BWBT15**
- BWBT18**

- One standard height full-width drawer
- Door is attached to wastebasket assembly and is pulled open to access basket(s)
- Wastebasket assembly rolls out on full-extension ball-bearing slides
- BWBT15 has one 35 qt. white plastic basket and one 5 1/2" deep white plastic tray for garbage bag storage
- BWBT18 has two 35 qt. white plastic baskets (no garbage bag tray storage)
- Hardwood veneer tray supports easily removable basket(s)
- 35 qt. basket size is 10 1/2" x 14 5/8" x 18" tall

❖ SST ⑦	4ST ⑩d
● SDT ⑦	1FT ⑩d
HDS ⑩d	2FT ⑩d
FDS ⑩d	● CFO ⑩g
1ST ⑩d	● CSO ⑩g
2ST ⑩d	

Base Sink Cabinets

- SST Construction ----- (7)
- SDT Construction ----- (7)
- CFO Cabinet Front Only ----- (10g)
- CSO Case Only ----- (10g)

Construction Options and Modifications

- ❖ Included as standard
 - Available with an upcharge
 - ☆ Available with exceptions
- (Blank) **Not** available

(10a)

SB24BFH

CoreGuard® Sink Base

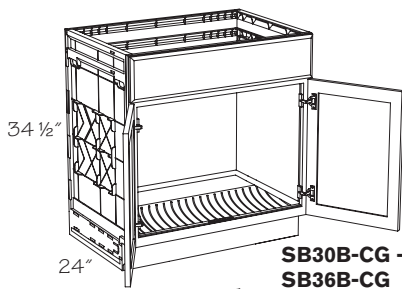

(10a)

Without Utility Tray

SB30B-CG
SB33B-CG
SB36B-CG

With Utility Tray

SB30BUT-CG
SB33BUT-CG
SB36BUT-CG

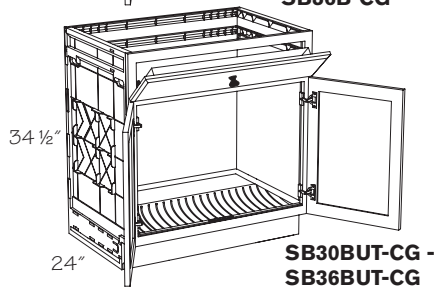

- No shelf
- One full-width false drawer front above doors
- Light beige color interior
- Cabinets have BUTT doors without a center frame stile
- Available for order with all door styles
- Decorative end panel required for end of peninsula or island. **Not** Included, order separately
- Bottom panel slants 1° toward front of cabinet and has raised ribs to slightly elevate stored items
- Easy to clean and durable sink base helps protect the cabinetry from everyday leaks and spills
- For cabinet back panel plumbing installation errors, CoreGuard® Panel Backer is available. See CGPB36 in Panels section. Order separately
- ☆ Regardless of construction option, model is constructed the same
- ☆ Available in all construction options, shipped with back, end and bottom panels made of an engineered polymer material
- ☆ **Note:** Case Only (CSO) option **not** available with cabinets "With a Utility Tray"

- ☆ SST (7)
- ☆ SDT (7)
- CFO (10g)
- ☆ CSO (10g)

Opening Sizes

Cabinet	Top Width	Top Depth
SB30B-CG	27 1/16"	22 3/8"
SB33B-CG	30 1/16"	22 3/8"
SB36B-CG	33 1/16"	22 3/8"
SB30BUT-CG	27 1/16"	22 3/8"
SB33BUT-CG	30 1/16"	22 3/8"
SB36BUT-CG	33 1/16"	22 3/8"

Caution: For an island/peninsula installation, the CoreGuard® Sink cabinet **must** have a minimum of one (1) 15" cabinet or larger installed adjacent to it in order for the island/peninsula to have adequate structural stability. Accessories **cannot** be installed on end panels, back or floor of the cabinet

Sink Base Single Door

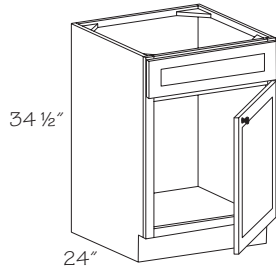

10a

10c

Specify R or L

- SB12 R or L**
- SB15 R or L**
- SB18 R or L**
- SB21 R or L**
- SB24 R or L**

With Utility Tray

- SB24UT R or L**

- No shelf
- One full-width false drawer front
- Back panel is pre-drilled for optional accessory Tray Kits
- ☆ **Note:** Cabinet Front Only (CFO) and Case Only (CSO) option is **not** available for cabinets "With a Utility Tray"

❖ SST 7

❖ SDT 7

☆ CFO 10g

☆ CSO 10g

Sink Base Single Door Full-Height

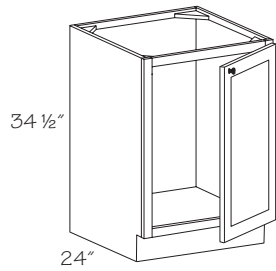

10a

10c

Specify R or L

- SB24FH R or L**

- No shelf
- Specify right or left hinging
- Back panel is pre-drilled for optional accessory Tray Kits

❖ SST 7

❖ SDT 7

● CFO 10g

● CSO 10g

Sink Base Double Door

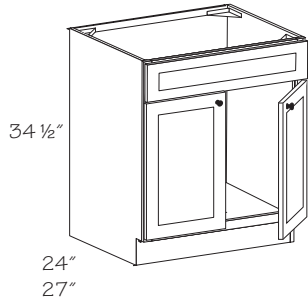

10a

10a

24" Deep

- SB24B**
- SB27B**
- SB30B**
- SB33B**
- SB36B**
- SB39**
- SB42**
- SB48**

24" Deep
With Utility Tray

- SB24BUT**
- SB27BUT**
- SB30BUT**
- SB33BUT**
- SB36BUT**
- SB39UT**
- SB42UT**
- SB48UT**

- No shelf
- One full-width false drawer front above doors except SB42, SB42UT, SB4227, SB4227UT, SB48 and SB48UT which have two drawer fronts
- Cabinets with a "B" suffix have BUTT doors without a center stile
- Back panel is pre-drilled for optional accessory Tray Kits
- Roll-out tray **not** available for 27" deep cabinets
- ☆ Cabinet Front Only (CFO) and Case Only (CSO) options **not** available with cabinets with a Utility Tray (UT)

❖ SST 7

❖ SDT 7

☆ CFO 10g

☆ CSO 10g

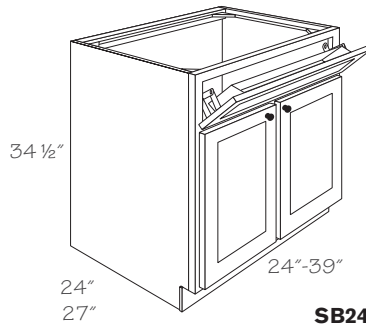

27" Deep

- SB2727B**
- SB3027B**
- SB3327B**
- SB3627B**
- SB4227**

27" Deep
With Utility Tray

- SB2727BUT**
- SB3027BUT**
- SB3327BUT**
- SB3627BUT**
- SB4227UT**

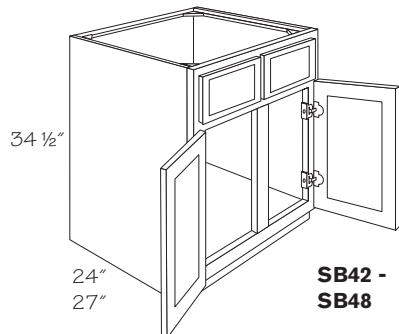

34 1/2"

24"
27"

- SB42 - SB48**

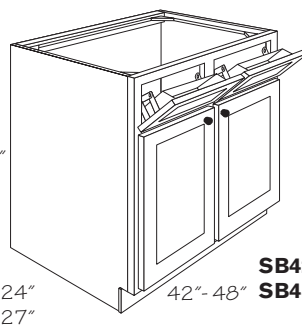

- SB42UT - SB48UT**

Sink Base Double Door Full-Height

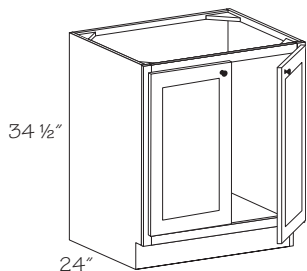

⑩a
SB24BFH
SB27BFH
SB30BFH
SB36BFH

- No shelf
- Cabinets have BUTT doors without a center frame stile
- Back panel is pre-drilled for optional accessory Tray Kits

- ❖ SST ⑦
- ❖ SDT ⑦
- CFO ⑩g
- CSO ⑩g

Sink Front Single Door

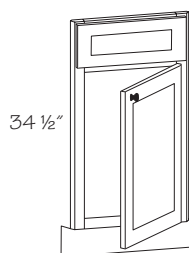

⑩a ⑩c
Specify R or L
SF24 R or L

- **Not** trimmable
- One full-width false drawer front
- Toespace (toe kick backer assembly) included, shipped unattached
- Bottom panel **not** included, order separately. See Sink Front Bottom (SFB2336)
- ☆ Regardless of construction option, model is shipped the same

- ☆ SST ⑦
- ☆ SDT ⑦
- CFO ⑩g
- CSO ⑩g

Sink Front Single Door Full-Height

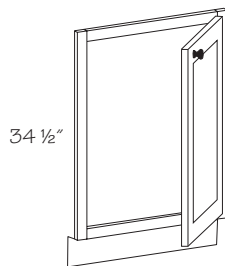

⑩a
SF24FH

- **Not** trimmable
- Invertible for right or left hand use
- Toespace (toe kick backer assembly) included, shipped unattached
- Bottom panel **not** included, order separately. See Sink Front Bottom (SFB2336)
- ☆ Regardless of construction option, model is shipped the same

- ☆ SST ⑦
- ☆ SDT ⑦
- CFO ⑩g
- CSO ⑩g

Sink Front Double Door

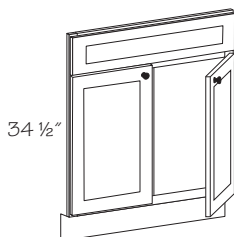

⑩a
SF24B
SF30B
SF36B

- **Not** trimmable
- One full-width false drawer front
- Cabinets have BUTT doors without a center frame stile
- Toespace (toe kick backer assembly) included, shipped unattached
- Bottom panel **not** included, order separately. See Sink Front Bottom (SFB2336)
- ☆ Regardless of construction option, model is shipped the same

- ☆ SST ⑦
- ☆ SDT ⑦
- CFO ⑩g
- CSO ⑩g

Sink Front Double Door Full-Height

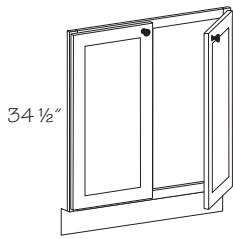

⑩a

SF24BFH
SF30BFH
SF36BFH

- **Not** trimmable
- Cabinets have BUTT doors without a center frame stile
- Toespace (toe kick backer assembly) included, shipped unattached
- Bottom panel **not** included, order separately. See Sink Front Bottom (SFB2336)
- ☆ Regardless of construction option, model is shipped the same

- ☆ SST ⑦
- ☆ SDT ⑦
- CFO ⑩g
- CSO ⑩g

Sink Base Angle

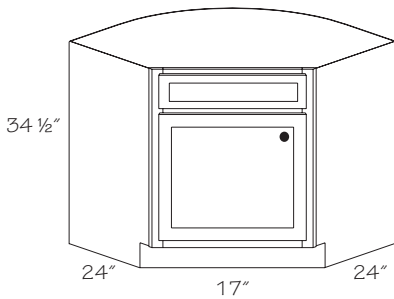

⑩a

⑩c

Specify R or L
SBA36 R or L

- One full-width false drawer front above door
- Full overlay sink front door and false drawer front are similar in width to traditional overlay cabinets in order to avoid interference with adjacent cabinet doors. This exposes more of the cabinet face frame
- Top panel **must** be cut in field to receive sink
- Use Base End Panel Filler (BEPF3-34) if end is exposed (requires 3" of space)
- 29 1/4" minimum doorway clearance required for delivery with cabinet door removed
- Adjacent cabinets can be installed directly without fillers

- ◆ SST ⑦
- ◆ SDT ⑦
- CFO ⑩g
- CSO ⑩g

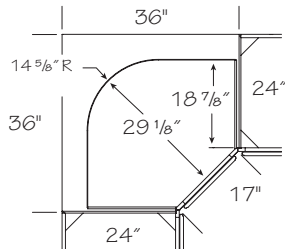

Caution: If cabinet is installed next to an appliance deeper than 25", it may interfere with the cabinet door opening. Options available:
 A) Use a filler between cabinet and appliance,
 B) Pull cabinet even with appliance front, which will result in a deeper countertop and overall base cabinet depth dimension

Base Corner Cabinets

Construction Options and Modifications

- ❖ Included as standard
 - Available with an upcharge
 - ☆ Available with exceptions
- (Blank) **Not** available

- SST Construction ----- (7)
- SDT Construction ----- (7)
- HDS Half Depth Shelf ----- (10d)
- FDS Full Depth Shelf ----- (10d)
- 1ST 1 Standard Tray ----- (10d)
- 2ST 2 Standard Trays ----- (10d)
- 1FT 1 Standard Full-Width Tray -- (10d)
- 2FT 2 Standard Full-Width Trays - (10d)
- CFO Cabinet Front Only ----- (10g)
- CSO Case Only ----- (10g)

(10a) **BBC39/42**

(10c) **BR**

(10d) **HDS**

Base Blind Corner Cabinet Information

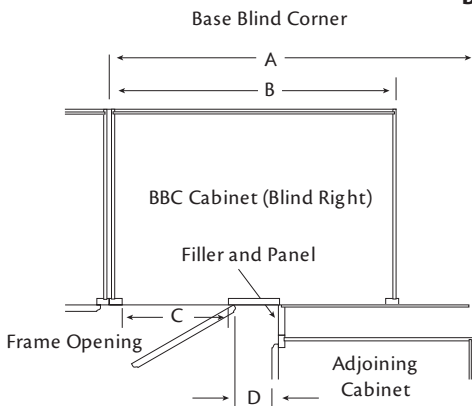

- Base blind corner cabinets provide access to corner space and permit adjustability of up to 2 7/8" maximum to aid in kitchen layout. Consult chart for "pull" dimensions and minimum wall space requirements
- "Pulling" the cabinet away from the corner (adding up to 2 7/8" maximum to the void area), and using the supplied filler and panel, provides clearance for opening doors and drawers when decorative hardware is used
- BR or BL indicates blind end of cabinet. Please specify.
- Door hinged on same side as blind
- Blind side **must** be ordered left or right
- Full overlay products **must** be pulled the maximum 2 7/8" for proper hardware clearance for drawer and roll-out tray of adjoining cabinet
- **Note:** A 3" Base Filler and Blind Panel is included with each BBC cabinet ordered, shipped unattached

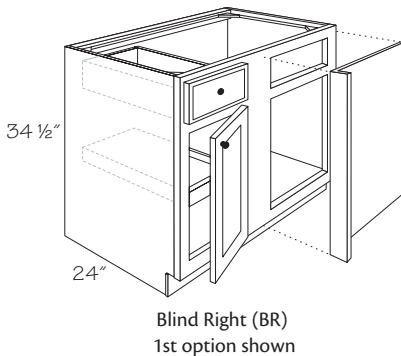

Base Blind Corner	(A) Wall Space		(B) Cabinet Width	(C) Frame Opening		(D) Door Hardware Clearance	
	No Pull	Max Pull		Drawer Opening	Door Opening	No Pull	Max Pull
	BBC39/42	39"	41 7/8"	30"	5" h x 10 1/2" w	10 1/2" w x 20 1/2" h	1 5/8"
BBC42/45	42"	44 7/8"	36"	5" h x 13 1/2" w	13 1/2" w x 20 1/2" h	1 5/8"	4 1/2"
BBC45/48	45"	47 7/8"	42"	5" h x 16 1/2" w	16 1/2" w x 20 1/2" h	1 5/8"	4 1/2"
BBC48/51	48"	50 7/8"	48"	5" h x 19 1/2" w	19 1/2" w x 20 1/2" h	1 5/8"	4 1/2"

Full Overlay							
Base Blind Corner	(A) Wall Space		(B) Cabinet Width	(C) Frame Opening		(D) Door Hardware Clearance	
	No Pull	Max Pull		Drawer Opening	Door Opening	No Pull	Max Pull
BBC39/42	39"	41 7/8"	30"	5" h x 10 1/2" w	10 1/2" w x 20 1/2" h	13/16"	3 11/16"
BBC42/45	42"	44 7/8"	36"	5" h x 13 1/2" w	13 1/2" w x 20 1/2" h	13/16"	3 11/16"
BBC45/48	45"	47 7/8"	42"	5" h x 16 1/2" w	16 1/2" w x 20 1/2" h	13/16"	3 11/16"
BBC48/51	48"	50 7/8"	48"	5" h x 19 1/2" w	19 1/2" w x 20 1/2" h	13/16"	3 11/16"

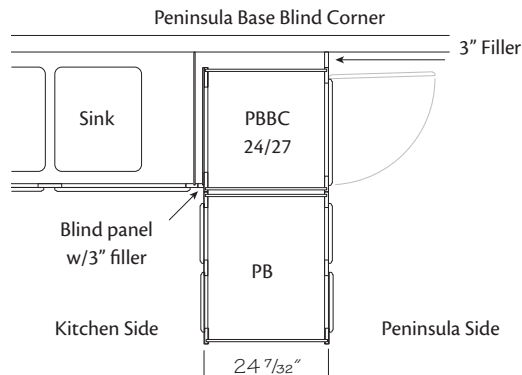
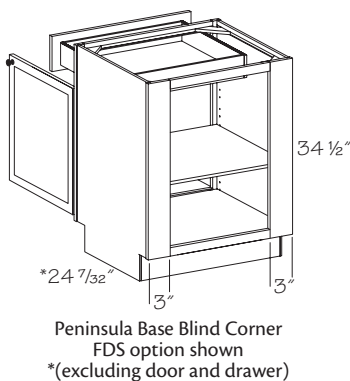
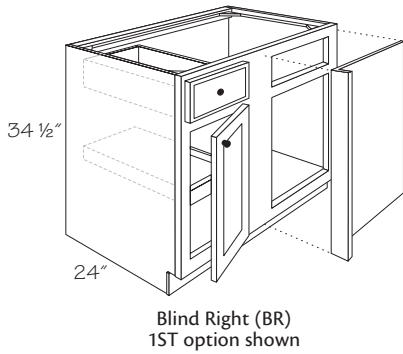

Illustration is Right Hand hinging

Base Blind Corner



10a
 Specify BR or BL
BBC39/42 BR or BL
BBC42/45 BR or BL
BBC45/48 BR or BL
BBC48/51 BR or BL

10d
HDS
HDS
HDS
HDS

- Standard height top drawer
- Door hinged to center stile
- Blind Panel with 3" filler included, shipped unattached
- Do **not** pull cabinet more than 2 7/8". This is **not** the space from the wall to the cabinet. This varies depending on cabinet size
- Back panel is pre-drilled for optional accessory Tray Kits
- **Note:** For tray or shelf options for select cabinets, replace HDS (10d) with the option code of your choice

❖ SST 7	2ST 10d
● SDT 7	1FT 10d
❖ HDS 10d	2FT 10d
● FDS 10d	● CFO 10g
● 1ST 10d	● CSO 10g

Peninsula Base Single Door Blind Corner

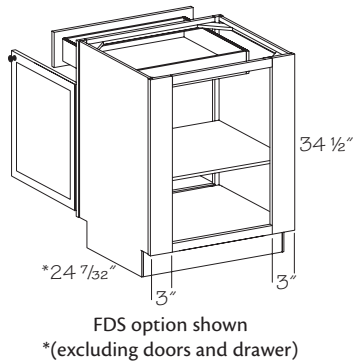

10a 10c 10d
 Specify R or L
PBBC24/27 R or L FDS

- Cabinet is 24" wide
- Cabinet can be pulled a maximum of 3" from wall
- One door on peninsula side
- One standard height top drawer opens on peninsula side
- Use to start a peninsula run
- One 3" filler (BF3) included, shipped unattached
- Blind Panel with 3" filler included, shipped unattached
- Back face frames are pre-drilled for optional roll out trays
- **Note:** Full depth shelf (FDS) option or a tray option **must** be selected for this cabinet

❖ SST 7	● 2ST 10d
● SDT 7	1FT 10d
HDS 10d	2FT 10d
● FDS 10d	● CFO 10g
● 1ST 10d	● CSO 10g

Peninsula Base Butt Door Blind Corner

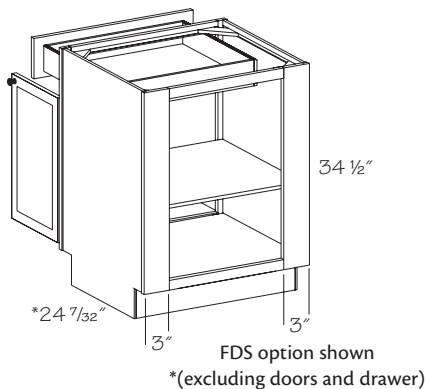

10a 10d
PBBC24/27B FDS

- Cabinet is 24" wide
- Cabinet can be pulled a maximum of 3" from wall
- Cabinet has Butt doors without frame center stile on peninsula side
- One standard height top drawer opens on peninsula side
- Use to start a peninsula run
- One 3" filler (BF3) included, shipped unattached
- Blind Panel with 3" filler included, shipped unattached
- Back face frames are pre-drilled for optional roll out trays
- **Note:** Full depth shelf (FDS) option or a tray option **must** be selected for this cabinet

❖ SST 7	2ST 10d
● SDT 7	● 1FT 10d
HDS 10d	● 2FT 10d
● FDS 10d	● CFO 10g
1ST 10d	● CSO 10g

Base Lazy Susan

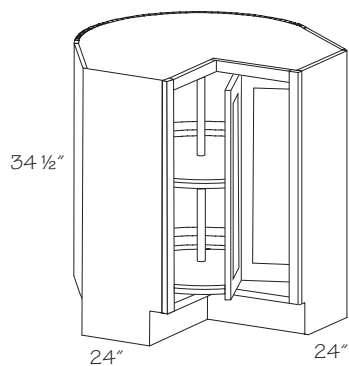

⑩a
BLS36

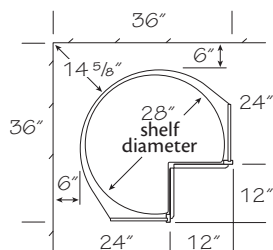

- Two 28" diameter high impact, pie-cut revolving white plastic shelves
- Shelf load rating of 15 lbs. per square foot, **not** to exceed 50 lbs.
- Doors and shelves revolve as one unit
- Available in traditional overlay door styles only
- Use Base End Panel Filler (BEPF3-34) if end is exposed (requires 3" of space)

❖ SST ⑦	2ST ⑩d
❖ SDT ⑦	1FT ⑩d
HDS ⑩d	2FT ⑩d
FDS ⑩d	CFO ⑩g
1ST ⑩d	● CSO ⑩g

Base Corner Revolving

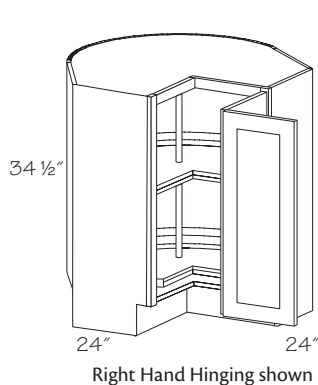

⑩a ⑩c
 Specify R or L
BCR33 R or L
BCR36 R or L

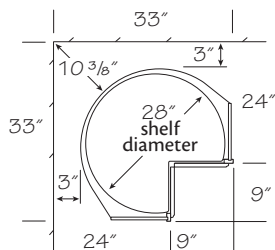

BCR33

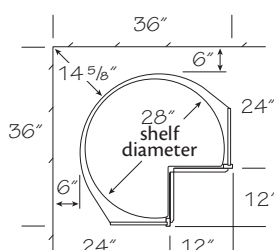

BCR36

- Two 28" diameter high impact, pie-cut revolving white plastic shelves
- Shelves rotate independently of doors and each other
- Shelf load rating of 15 lbs. per square foot, **not** to exceed 50 lbs.
- Shelf height **cannot** be adjusted
- Two piece bi-fold door with independent adjustment
- Use Base End Panel Filler (BEPF3-34) if end is exposed (requires 3" of space)
- 168° opening hinges on face frame door
- Full overlay door style face frame stiles are notched to accept door hinges. Door hinging **cannot** be inverted in field

❖ SST ⑦	2ST ⑩d
❖ SDT ⑦	1FT ⑩d
HDS ⑩d	2FT ⑩d
FDS ⑩d	● CFO ⑩g
1ST ⑩d	● CSO ⑩g

! Caution: If cabinet is installed next to an appliance deeper than 25", it may interfere with the cabinet door opening. Options available:
 A) Use a filler between cabinet and appliance,
 B) Pull cabinet even with appliance front, which will result in a deeper countertop and overall base cabinet depth dimension

Base Corner Fixed Shelf

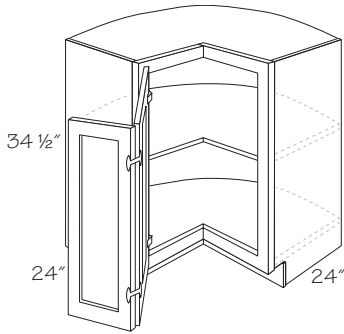

Left Hand Hinging shown

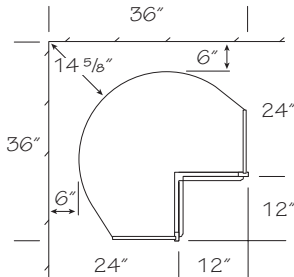

10a

10c

Specify R or L

BCFS36 R or L

- One fixed, pie-cut shelf in center position (**not** adjustable)
- Two piece bi-fold door with independent adjustment
- 168° opening hinges on face frame door
- Full overlay door style face frame stiles are notched to accept door hinges. Door hinging **cannot** be inverted in field
- Use Base End Panel Filler (BEPF3-34) if end is exposed (requires 3" of space)

❖ SST 7	2ST 10d
❖ SDT 7	1FT 10d
HDS 10d	2FT 10d
FDS 10d	● CFO 10g
1ST 10d	● CSO 10g



Caution: If cabinet is installed next to an appliance deeper than 25", it may interfere with the cabinet door opening. Options available:
 A) Use a filler between cabinet and appliance,
 B) Pull cabinet even with appliance front, which will result in a deeper countertop and overall base cabinet depth dimension

Base Accessories

HW	Hardwood	-----	(2)
MP	Maple	-----	(2)
RO	Red Oak	-----	(2)
TH	Thermofoil	-----	(2)

Construction Options and Modifications

- ❖ Included as standard
 - Available with an upcharge
 - ☆ Available with exceptions
- (Blank) **Not** available

(10a)
MBEP2434

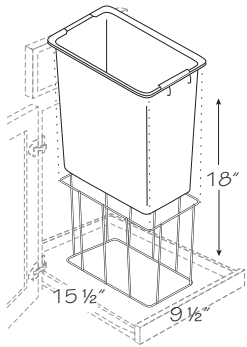

Base Wastebasket Floor Mount Kit Single

(10a)
BWBFMK

- White epoxy coated wire
- Requires base cabinet roll-out tray in the bottom position, **not** included
- Fits base cabinets 15" or wider
- Includes 30 qt. white plastic bin
- Installation instructions and mounting hardware included
- One per carton

HW	(2)
MP	(2)
RO	(2)
TH	(2)

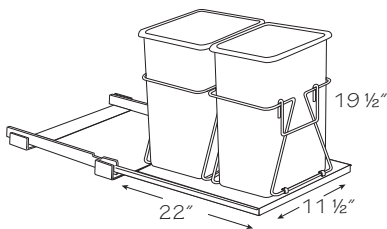

Base Wastebasket Floor Mount Kit Double

(10a)
BWBFMK-2

- White epoxy coated wire
- Bins mounted on white laminated platform with full extension slides
- 11 1/2" wide pull out, fits minimum 15" single door cabinet or 27" double door cabinet unless cabinet is butt door
- Includes two 27-qt. white plastic bins
- Load rated at 40 lbs.
- Does **not** fit 9" or 12" wide base or 27" wide base with center stile
- Installation instructions and mounting hardware included
- One per carton

HW	(2)
MP	(2)
RO	(2)
TH	(2)

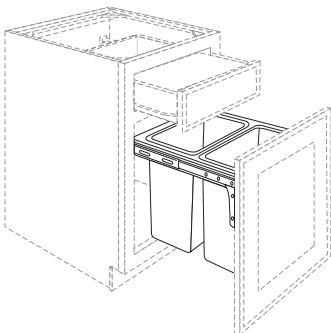

BWBTK18-2 shown

Base Wastebasket Top Mount Kit

(10a)
BWBTK15
BWBTK18-2

- Fits B15 or B18 cabinets
- BWBTK15 includes one 35 qt. white plastic basket and one 5 1/2" deep white plastic tray for garbage bag storage
- BWBTK18-2 includes two 35 qt. white plastic baskets (no bag storage tray)
- Wastebasket assembly rolls out on full-extension ball-bearing slides
- Hardwood veneer tray supports easily removable basket(s)
- 35 qt. basket is 10 1/2" x 14 5/8" x 18" high
- Installation instructions and mounting hardware included
- One per carton

HW	(2)
MP	(2)
RO	(2)
TH	(2)

Sink Front Bottom

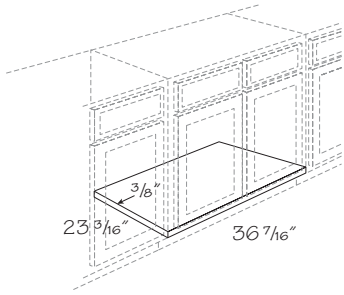

10a
SFB2336

- Designed to be used as an optional cabinet bottom with SF24, SF24B, SF30, SF30B, SF36, SF24FH, SF24BFH, SF30FH, SF30BFH and SF36FH sink fronts
- Fits SF36B and SF36BFH without field trimming; field trim to length required for remaining sizes
- 36 7/16" long x 23 3/16" wide
- Easy to clean natural woodgrain laminate on one side; backside unfinished
- 3/8" thick engineered wood core
- Installation screws included
- One per carton

HW 2
 MP 2
 RO 2
 TH 2

Cutlery Divider

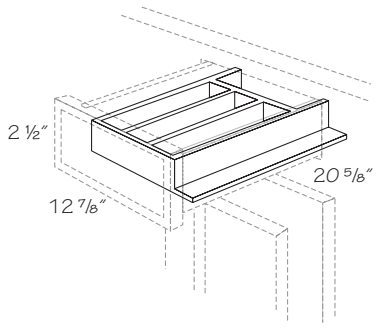

10a
CDI18

- 1/2" thick engineered wood dividers with Natural woodgrain laminate and matching top edges
- 1/4" thick engineered wood bottom panel with Natural woodgrain laminate on exposed surface
- Clean with a damp cloth only
- Five compartment cutlery organizer for 18" wide cabinets; can be cut down for 15" wide cabinets
- When used in Dovetail hardwood full extension drawer, 1 5/16" **must** be field cut off back edge
- One per carton

HW 2
 MP 2
 RO 2
 TH 2

Utility Tray Kit

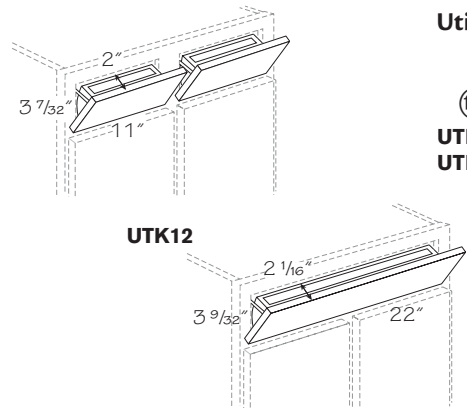

10a
UTK12
UTK22

- Removable high-impact white plastic tray installs on backside of drawer front for convenient out-of-sight storage of small items, soap, scouring pads, etc.
- UTK22 fits sink base cabinets 27" through 39" wide
- UTK12 fits sink base cabinets 30" or wider
- Concealed self-closing hinges allow drawer front to tilt down 51° for tray access
- Hinge detent holds drawer front in full open position
- Order decorative hardware separately
- Installation instructions and mounting hardware included
- One per carton

HW 2
 MP 2
 RO 2
 TH 2

If installing one UTK12 on a 24" or 27" wide sink base, consider utilizing the second tray on the backside for storage

UTK22

Toe Kick Cover - Laminate

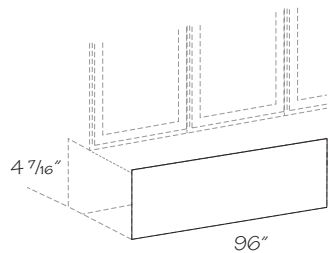

10a
 1/8" Thick
TKCL8

- Matching easy clean laminate on one side
- Grain direction runs lengthwise (when applicable)
- Available in all finishes; Maple Accent Glaze shipped standard finish
- Offered in individual 8' lengths

HW 2
 MP 2
 RO 2
 TH 2

Toe Kick Cover - Veneer

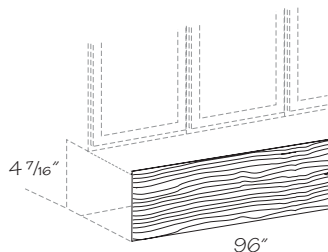

10a
 5/32" Thick
TKCV8

- Matching wood veneer plywood finished on one side, grain direction runs lengthwise
- Available in all finishes; Maple Accent Glaze shipped standard finish
- Offered in individual 8' lengths

HW 2
 MP 2
 RO 2
 TH 2

Base Filler

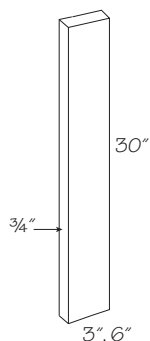

⑩a
BF3
BF6

- 3/4" thick solid wood
- Backside of filler **not** finished
- Available in all finishes; Maple Accent Glaze shipped standard finish
- Available in all painted finishes, which are painted hardwood
- One per carton

- ❖ HW ②
- ❖ MP ②
- ❖ RO ②
- ❖ TH ②

Base Filler Corner

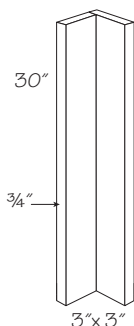

⑩a
BFC3

- Used to provide clearance between cabinets when corner space is **not** used
- 3/4" thick solid wood
- 3" faces
- Backside of filler **not** finished
- Available in all finishes; Maple Accent Glaze shipped standard finish
- Available in all painted finishes, which are painted hardwood
- Shipped assembled
- One per carton

- ❖ HW ②
- ❖ MP ②
- ❖ RO ②
- ❖ TH ②

Base End Panel Filler

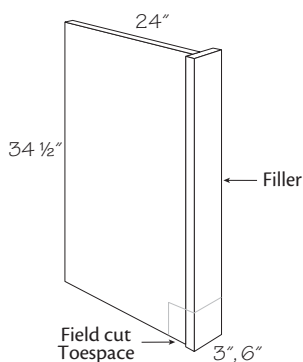

⑩a
BEPF3-34
BEPF3-34-2
BEPF6-34

- Used on the end of cabinet run to conceal dishwasher or cap end of BCFS/BCR/BLS cabinets
- For right or left hand use
- Toespace notch **must** be field cut
- Available in all finishes; Maple Accent Glaze shipped standard finish
- Available in all painted finishes, which are painted hardwood
- BEPF3-34 offered individually or two per carton; BEPF6-34 offered individually

- ❖ HW ②
- ❖ MP ②
- ❖ RO ②
- ❖ TH ②

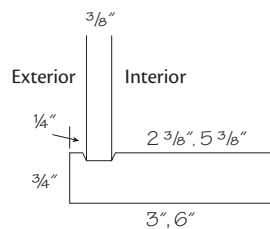

Base End Panel

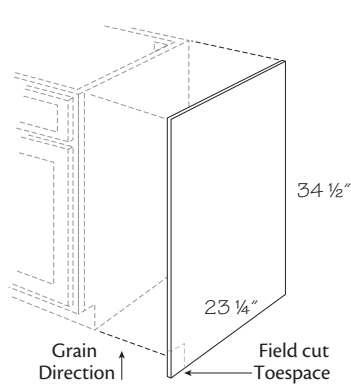

⑩a
BEP
BEP-6

- Used to trim laminate exposed end of base cabinet
- For right or left hand use
- 5/32" thick veneered plywood panel, except White, finished on one side; grain runs lengthwise
- 3/16" thick laminate panel for White; finished on one side only
- Available in all finishes; Maple Accent Glaze shipped standard finish
- Available in all painted finishes, which are painted hardwood
- Toespace notch **must** be field cut
- Offered individually or six per carton

- ❖ HW ②
- ❖ MP ②
- ❖ RO ②
- ❖ TH ②

Matching Base End Panel

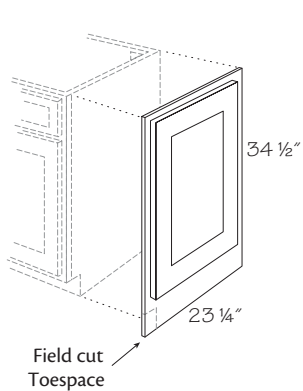

⑩a
MBEP2434

- Provides a finished furniture look to 34 1/2" base cabinets
- Includes end panel with decorative door
- Available in all door styles and finishes
- For right or left hand use
- Available in all painted finishes, which are painted hardwood
- 5/32" thick veneered plywood panel, except Arbor Falls Express
- 3/16" thick white laminate panel for Arbor Falls Express
- Toespace notch **must** be field cut
- Traditional overlay doors are 22 1/4" x 28" tall shipped attached to panel
- Full overlay doors are 23 5/8" x 29 1/4" tall shipped unattached to panel. When installed, door overlaps cabinet frame edge to provide matching reveals
- One per carton

- ❖ HW ②
- ❖ MP ②
- ❖ RO ②
- ❖ TH ②

Notes

Tall Cabinets

Construction Options and Modifications

- ❖ Included as standard
- Available with an upcharge
- ☆ Available with exceptions

(Blank) **Not** available

SST Construction	-----	⑦
SDT Construction	-----	⑦
CFO Cabinet Front Only	-----	⑩g
CSO Case Only	-----	⑩g

Note: Standard tall cabinet box depth is 12" or 24" unless stated otherwise. Add door thickness with bumpers for total depth.

Material dimensions may vary slightly based on lumber industry standards.

Specifications subject to change without notice.



Tall Utility Cabinet 12" Deep

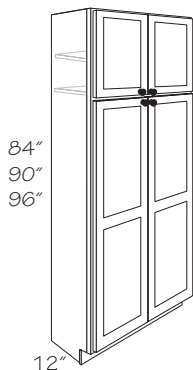
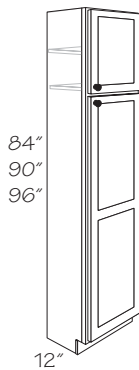

⑩a

⑩c

Specify R or L
84" High

U1884 R or L

U2484 R or L

U3084B

90" High

U1890 R or L

U2490 R or L

U3090B

96" High

U1896 R or L

U2496 R or L

U3096B

- ❖ **SST** ⑦
 - ❖ **SDT** ⑦
 - **CFO** ⑩g
 - **CSO** ⑩g
- Fixed shelf between top and bottom section with adjustable shelves in top section: 84" high-no shelves; 90" high-1 shelf; 96" high-2 shelves
 - Cabinets with a "B" suffix have BUTT doors without a center stile
 - Tall doors are two-piece panel construction except Arbor Falls Express
 - Arbor Falls Express tall doors have a single raised panel profile
 - 30" cabinets have 3" wide center stile in upper section only
 - Interior height of tall section on 84" and 96" tall cabinets is 60 15/16"; 90" tall is 61 7/16"
 - 96" tall cabinets include toe kick platform, shipped unattached
 - Toe kick cover required on exposed sides of toe kick platform
 - End panels of bottom section are pre-drilled for optional shelves



If ordering a 96" high unit, consider ordering a tall end panel to give a finished look to the exposed side of the cabinet

Tall Utility Cabinet 24" Deep

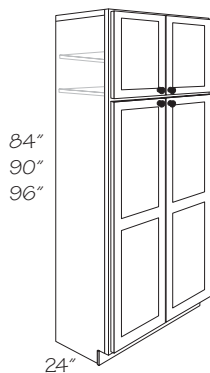
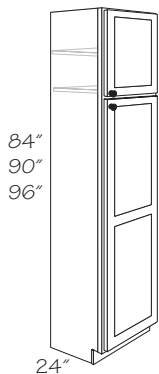

⑩a

⑩c

Specify R or L
84" High

U188424 R or L
U248424 R or L
U308424B

90" High

U189024 R or L
U249024 R or L
U309024B

96" High

U189624 R or L
U249624 R or L
U309624B

- Fixed shelf between top and bottom section with adjustable shelves in top section: 84" high-no shelves; 90" high-1 shelf; 96" high-2 shelves
- Cabinets with a "B" suffix have BUTT doors without a center stile
- Tall doors are two-piece panel construction except Arbor Falls Express
- Arbor Falls Express tall doors have a single raised panel profile
- 30" cabinets have 3" wide center stile in upper section only
- Interior height of tall section on 84" and 96" tall cabinets is 60 15/16"; 90" tall is 61 7/16"
- 96" tall cabinets include toe kick platform, shipped unattached
- Toe kick cover required on exposed sides of toe kick platform
- End panels of bottom section are pre-drilled for optional shelves and accessory Tray Kits

- ❖ SST ⑦
- ❖ SDT ⑦
- CFO ⑩g
- CSO ⑩g

 If ordering a 96" high unit, consider ordering a tall end panel to give a finished look to the exposed side of the cabinet

Utility Front

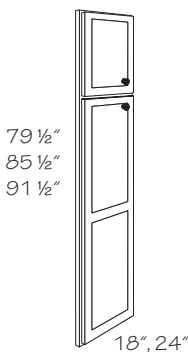

⑩a

⑩c

Specify R or L
84" High

UF1884 R or L
UF2484 R or L

90" High

UF1890 R or L
UF2490 R or L

96" High

UF1896 R or L
UF2496 R or L

- Includes face frame and appropriate hinged doors only
- Tall doors are two-piece panel construction except Arbor Falls Express
- Arbor Falls Express tall doors have a single raised panel profile
- Does **not** include toespace (toe kick backer) assembly
- ☆ Regardless of construction option, model is constructed the same

- ☆ SST ⑦
- ☆ SDT ⑦
- CFO ⑩g
- CSO ⑩g

Tall Appliance Cabinets

Construction Options and Modifications

- ❖ Included as standard
- Available with an upcharge
- ☆ Available with exceptions

(Blank) **Not** available

- SST Construction ----- (7)
- SDT Construction ----- (7)
- CFO Cabinet Front Only ----- (10g)
- CSO Case Only ----- (10g)

Oven Cabinet Frame Dimensions

Oven Cabinet Single (OCS)

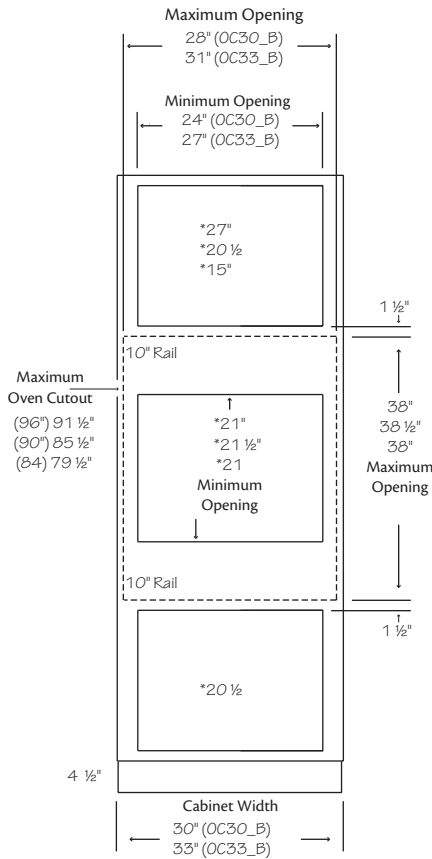

Oven Cabinet Universal (OCU)

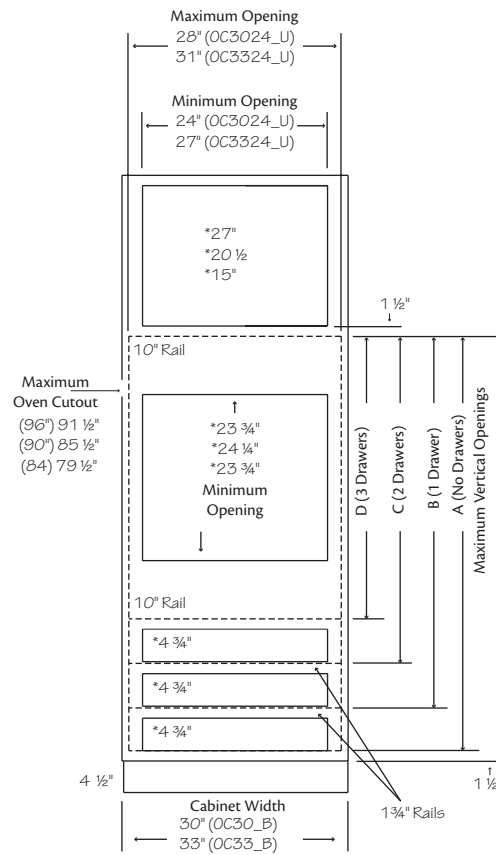

- Vertical opening sizes are preceded by an asterisk (*)
- Unless otherwise noted, all stiles and rails are 1 1/2" wide
- Unless otherwise noted, depth of cabinets excludes doors
- OCS cabinets with stained finishes have 1 1/2" face frame stiles. Painted finishes have 3" wide, trimmable stiles provide opening width adjustment
- OCU cabinets have 3" wide trimmable full-length vertical stiles that provide opening width adjustment
- Substitute " _ " with cabinet's height

Maximum Vertical Openings for Oven				
Cabinet Height	A	B	C	D
84"	60"	53 3/4"	47 1/4"	40 3/4"
90"	60 1/2"	54 1/4"	47 3/4"	41 1/4"
96"	60"	53 3/4"	47 1/4"	40 3/4"

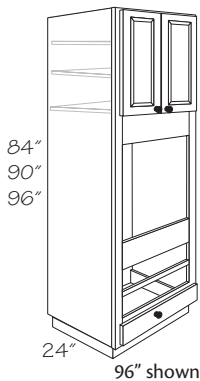

Oven Cabinet Universal

- (10a)
- 84" High
OCU3084B
OCU3384B
- 90" High
OCU3090B
OCU3390B
- 96" High
OCU3096B
OCU3396B

Fixed shelf between top and bottom section with adjustable shelves in top section: 84" high-no shelves; 90" high-1 shelf; 96" high-2 shelves

- Three full-width drawer openings at bottom
- Cabinets have BUTT doors without a frame center stile
- Includes one full-width drawer. Order additional drawer(s) as needed. See Oven Drawer Kit (ODK)
- Face-mounted door hinges provide matching frame reveals
- Center section accommodates single and double ovens by trimming or removing horizontal cross rails
- Face frame rails are attached to stiles with screws on the back side for easy removal
- 96" tall cabinets include toe kick platform, shipped unattached
- 3" wide, trimmable stiles provide opening width adjustment for painted finishes and White laminate. All other finishes have 1 1/2" wide removable, trimmable vertical stiles for easy adjustment
- Toe kick cover required on exposed sides of toe kick platform
- Includes adjustable 1" thick engineered wood oven platform with heavy-duty mounting brackets and screws that install into pre-drilled end panel holes. Order additional support platform kits as needed. See Oven Cabinet Shelf Platform (OCSP)

- ❖ SST (7)
- SDT (7)
- CFO (10g)
- CSO (10g)



If ordering a 96" high unit, consider ordering a tall end panel to give a finished look to the exposed side of the cabinet

Oven Cabinet Single

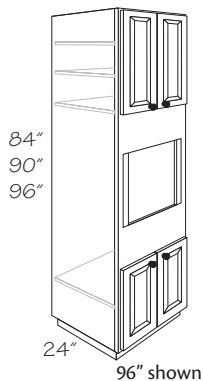

⑩a

- 84" High
OCS3084B
OCS3384B
- 90" High
OCS3090B
OCS3390B
- 96" High
OCS3096B
OCS3396B

- Fixed shelf between top and bottom section with adjustable shelves in top section: 84" high-no shelves; 90" high-1 shelf; 96" high-2 shelves
- One adjustable shelf in bottom section
- Cabinets have BUTT doors without a frame center stile
- Cabinet doors are: 5 1/2" shorter on top than the bottom for 84" high cabinets, are equal height on 90" high cabinets and are 6 1/2" taller on top than the bottom for 96" high cabinets
- Center section accommodates single ovens
- 96" tall cabinets include toe kick platform, shipped unattached
- 3" wide, trimmable stiles provide opening width adjustment for painted finishes and White laminate. All other finishes have 1 1/2" wide removable, trimmable vertical stiles for easy adjustment
- Toe kick cover required on exposed sides of toe kick platform
- Includes adjustable 1" thick engineered wood oven platform with heavy-duty mounting brackets and screws that install into pre-drilled end panel holes. Order additional support platform kits as needed. See Oven Cabinet Shelf Platform (OCSP)

- ❖ SST ⑦
- ❖ SDT ⑦
- CFO ⑩g
- CSO ⑩g



If ordering a 96" high unit, consider ordering a tall end panel to give a finished look to the exposed side of the cabinet

Oven Drawer Kit

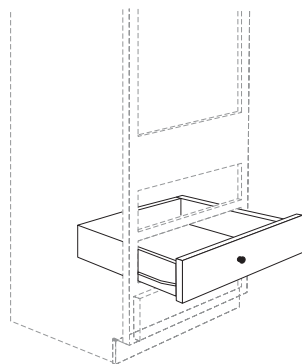

⑩a

- ODK30**
ODK33

- Available in all door styles
- Available with solid wood dovetail drawer core with under-mount drawer guides
- Kit includes:
1 drawer front
1 drawer core
Guides and all mounting hardware

- ❖ SST ⑦
- SDT ⑦
- CFO ⑩g
- CSO ⑩g

Oven Cabinet Support Platform

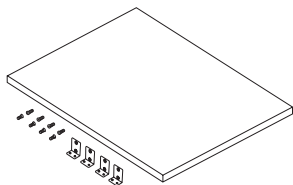

⑩a

- OCSP30**
OCSP33

- For installing second appliance in Oven Cabinet Universal (OCU); shelf platform and hardware same as included with OCU
- 1" thick engineered wood
- Includes four heavy-duty metal mounting brackets and eight screws which install into pre-drilled holes in cabinet end panels
- One per carton

- ❖ SST ⑦
- ❖ SDT ⑦
- CFO ⑩g
- CSO ⑩g

Item	Width	Depth
OCSP30	28 1/4"	22 7/16"
OCSP33	31 1/4"	22 7/16"

Tall Accessories

Construction Options and Modifications

- ❖ Included as standard
- Available with an upcharge
- ☆ Available with exceptions

(Blank) **Not** available

10a

MTEP2496

HW	Hardwood	-----	②
MP	Maple	-----	②
RO	Red Oak	-----	②
TH	Thermofoil	-----	②

Tall Filler

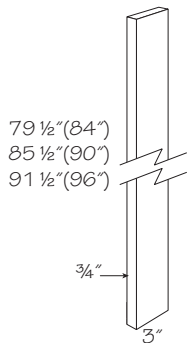

10a

TF3-84
TF3-90
TF3-96

- 3/4" thick solid wood
- Available in all finishes; Maple Accent Glaze shipped standard finish
- Available in all painted finishes, which are painted hardwood
- Backside of filler **not** finished
- One per carton

- ❖ HW ②
- ❖ MP ②
- ❖ RO ②
- ❖ TH ②

Toe Kick Cover - Laminate

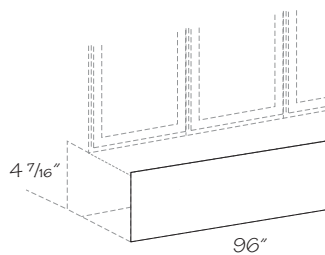

10a

1/8" Thick
TKCL8

- Matching easy clean laminate on one side
- Grain direction runs lengthwise (when applicable)
- Available in all finishes; Maple Accent Glaze shipped standard finish
- Offered in individual 8' lengths

- ❖ HW ②
- ❖ MP ②
- ❖ RO ②
- ❖ TH ②

Toe Kick Cover - Veneer

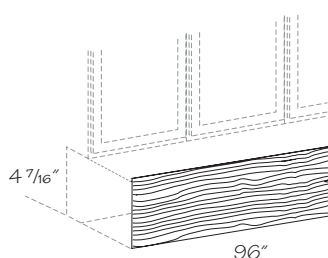

10a

5/32" Thick
TKCV8

- Matching wood veneer plywood finished on one side, grain direction runs lengthwise
- Available in all finishes; Maple Accent Glaze shipped standard finish
- Offered in individual 8' lengths

- ❖ HW ②
- ❖ MP ②
- ❖ RO ②
- ❖ TH ②

Tall End Panel

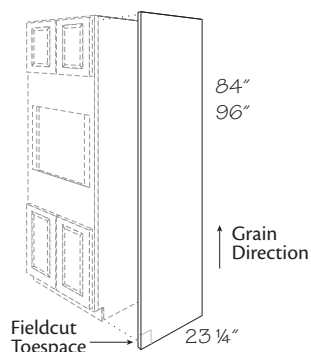

10a
TEPF84
TEPF96

- Optional panel used to trim laminate exposed end of tall cabinet
- Can also be used as decorative panel on doors of side by side refrigerator where trim kits from the refrigerator manufacturer are available
- For right or left hand use
- 5/32" thick veneered plywood panel, except White, finished on one side; grain runs lengthwise
- 3/16" thick laminate frontside and unfinished backside for White
- Available in all painted finishes, which are painted hardwood
- Toespace notch **must** be field cut
- Trimmed to fit installation
- One per carton

- ❖ HW 2
- ❖ MP 2
- ❖ RO 2
- ❖ TH 2

Tall End Panel Filler

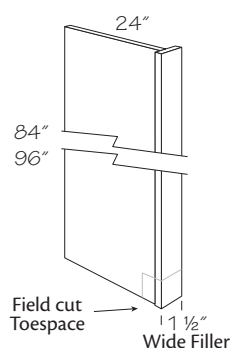

10a
TEPF1-84
TEPF1-96

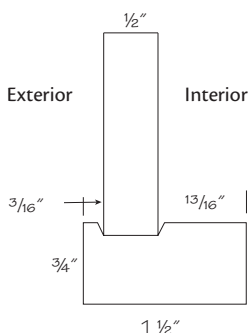

- Use next to refrigerator to conceal side, also supports 24" deep wall cabinet over refrigerator
- 1/2" thick plywood panel with matching veneer finish, except White
- 1/2" thick matching laminate on both sides for White
- Available in all finishes, except Maple Accent Glaze shipped standard finish
- Available in all painted finishes, which are painted hardwood
- Toespace notch **must** be field cut
- One per carton

- ❖ HW 2
- ❖ MP 2
- ❖ RO 2
- ❖ TH 2

Matching Tall End Panel

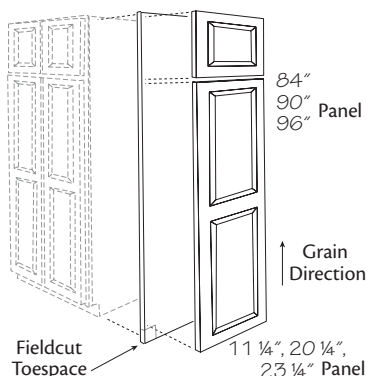

10a
 84" High
MTEP1284
MTEP2184
MTEP2484
 90" High
MTEP1290
MTEP2190
MTEP2490
 96" High
MTEP1296
MTEP2196
MTEP2496

- Provides a finished furniture look to Oven Cabinet Single (OCS), Oven Cabinet Universal (OCU), Utility Cabinet (UC) and Vanity Linen Cabinet Tall (VLC) ends
- For right or left hand use
- 5/32" thick plywood panel with one short and one tall decorative door, except Arbor Falls Express
- 3/16" thick white laminate panel with one short and one tall decorative door for Arbor Falls Express
- All full overlay door styles overlap cabinet frame to match reveals
- Toespace notch **must** be field cut
- Doors and panel are shipped separately; field assembly required
- Available in all door styles and finishes

- ❖ HW 2
- ❖ MP 2
- ❖ RO 2
- ❖ TH 2

Panel Size		
Item	Width	Height
MTEP1284	11 1/4"	84"
MTEP2184	20 1/4"	84"
MTEP2484	23 1/4"	84"
MTEP1290	11 1/4"	90"
MTEP2190	20 1/4"	90"
MTEP2490	23 1/4"	90"
MTEP1296	11 1/4"	96"
MTEP2196	20 1/4"	96"
MTEP2496	23 1/4"	96"

Vanity Cabinets

Construction Options and Modifications

- ❖ Included as standard
- Available with an upcharge
- ☆ Available with exceptions

(Blank) **Not** available

SST Construction	-----	(7)
SDT Construction	-----	(7)
CFO Cabinet Front Only	-----	(10g)
CSO Case Only	-----	(10g)

(10a) (10c)
VB12 **L**

Vanity Base Single Door

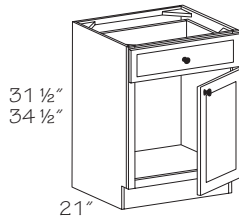

(10a)	(10c)	(10a)	(10c)
<i>Specify R or L</i>		<i>Specify R or L</i>	
21" Deep		21" Deep	
31 1/2" High		34 1/2" High	
VB12	R or L	VB1235	R or L
VB15	R or L	VB1535	R or L
VB18	R or L	VB1835	R or L
VB21	R or L	VB2135	R or L
		VB2435	R or L

- Standard height top drawer
- Back is pre-drilled for optional bottom and mid-height accessory Tray Kits. See tray availability charts in the Trays section

- ❖ **SST** (7)
- **SDT** (7)
- **CFO** (10g)
- **CSO** (10g)

Vanity Base Single Door Full-Height

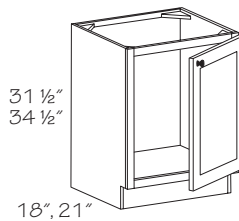

(10a)	(10c)	(10a)	(10c)
<i>Specify R or L</i>		<i>Specify R or L</i>	
31 1/2" High		34 1/2" High	
18" Deep		18" Deep	
VB1818FH	R or L	VB243518SFH	R or L
VB2118FH	R or L		
21" Deep		21" Deep	
VB18FH	R or L	VB1835FH	R or L
VB21FH	R or L	VB2135FH	R or L
VB24SFH	R or L	VB2435SFH	R or L

- Back is pre-drilled for optional bottom and mid-height accessory Tray Kits. See tray availability charts in the Trays section

- ❖ **SST** (7)
- ❖ **SDT** (7)
- **CFO** (10g)
- **CSO** (10g)

Vanity Base Double Door

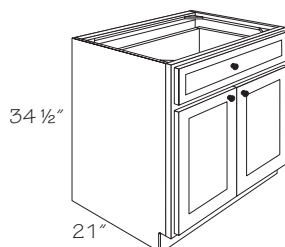

(10a)
 34 1/2" High
VB2435B

- Standard height top drawer
- Cabinets have BUTT doors without a frame center stile
- Back is pre-drilled for optional bottom and mid-height accessory Tray Kits. See tray availability charts in the Trays section

- ❖ **SST** (7)
- **SDT** (7)
- **CFO** (10g)
- **CSO** (10g)

Vanity Base Double Door Full-Height

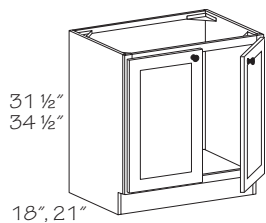

⑩a

31 1/2" High
 18" Deep
VB3018BFH
VB3618BFH
VB4218FH
 21" Deep
VB30BFH
VB36BFH
VB42FH

⑩a

34 1/2" High
 18" Deep
VB243518BFH
VB303518BFH
VB363518BFH
 21" Deep
VB2435BFH
VB3035BFH
VB3635BFH
VB4235FH

- Cabinets with a "B" suffix have BUTT doors without a center stile
- Back is pre-drilled for optional bottom and mid-height accessory Tray Kits. See tray availability charts in the Trays section

- ❖ SST ⑦
- ❖ SDT ⑦
- CFO ⑩g
- CSO ⑩g

Vanity Base Three Door Full-Height

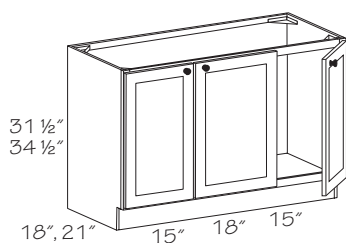

⑩a

18" Deep
 31 1/2" High
VB4818FH
 21" Deep
VB48FH
 21" Deep
 34 1/2" High
VB4835FH

- Center door on 48" cabinets is 3" wider than outer doors
- Center door is hinged right
- Back is pre-drilled for optional bottom and mid-height accessory Tray Kits that fit behind outer doors. See tray availability charts in the Trays section

- ❖ SST ⑦
- ❖ SDT ⑦
- CFO ⑩g
- CSO ⑩g

Vanity Base Four Door Full-Height

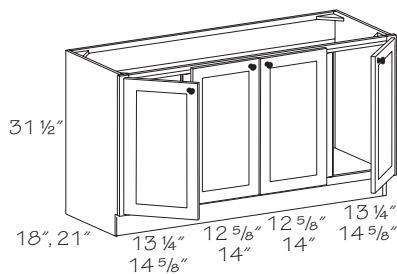

⑩a

18" Deep
 31 1/2" High
VB6018FH
 21" Deep
VB60FH

- Actual cabinet width is 59 1/2", traditional overlay cabinet frame stiles are extended and may be trimmed a maximum of 1/2" each to a cabinet width of 58 1/2"
- Traditional overlay inner doors are 12 5/8" wide and outer doors are 13 1/4" wide. Full overlay inner doors are 14" wide and outer doors are 14 5/8"
- Door left of center hinged left, door right of center hinged right
- 3 3/16" wide full-width support crossrail across top front of cabinet
- Back is pre-drilled for optional bottom and mid-height accessory Tray Kits that fit behind outer doors. See tray availability charts in the Trays section
- Tray Kits are **not** available for center doors

- ❖ SST ⑦
- ❖ SDT ⑦
- CFO ⑩g
- CSO ⑩g

Vanity Sink Base Butt Door

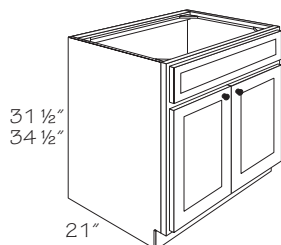

⑩a

21" Deep
 31 1/2" High
VSB30B
VSB36B
VSB42
 34 1/2" High
VSB2435B
VSB3035B
VSB3635B
VSB4235

- No shelf
- All cabinets have one full-width drawer front except VSB42 and VSB4235 which have two drawer fronts
- Cabinets with a "B" suffix have BUTT doors without a center stile
- Back is pre-drilled for optional bottom and mid-height accessory Tray Kits. See tray availability charts in the Trays section

- ❖ SST ⑦
- ❖ SDT ⑦
- CFO ⑩g
- CSO ⑩g

Vanity Sink Base Double Bowl

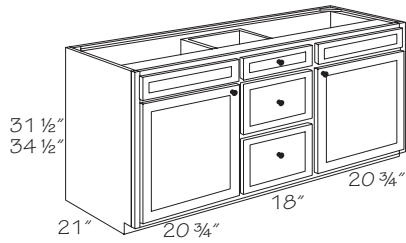

10a

21" Deep
31 1/2" High
VSB60-3D
34 1/2" High
VSB6035-4D

- VSB 31 1/2" high cabinets have 3 drawers in the center section, 1 top drawer of standard height, 2 deep drawers below
- VSB 34 1/2" high cabinets have four drawers in the center section, three top drawers of standard height and one deep drawer below
- One full-width false drawer front above doors
- Actual cabinet width is 59 1/2", frame stiles are extended and may be trimmed a maximum of 1/2" each to a cabinet width of 58 1/2"
- 3 3/16" wide full-width support crossrail across top front of cabinet
- Instructions and hardware included to convert the top drawer into drawer front only for larger vanity bowls

- ❖ **SST** (7)
- **SDT** (7)
- **CFO** (10g)
- **CSO** (10g)

Vanity Sink Base Two Drawer Double Door

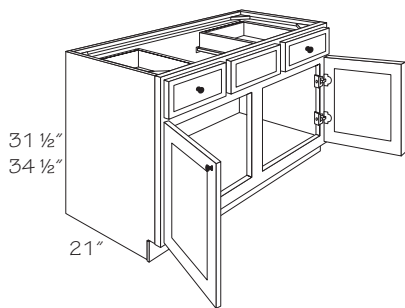

10a

21" Deep
31 1/2" High
VSB36-2D
34 1/2" High
VSB3635-2D

- False front only between drawers
- Space between drawers for sink installation is 18"
- Back is pre-drilled for optional bottom and mid-height accessory Tray Kits. See tray availability charts in the Trays section
- **Note:** Two standard height top drawers. Drawer fronts are offset from drawer core. This limits the sizes of pulls that can be positioned in the middle of the drawer front to pulls with 6" centers or 3" and narrower centers. See details.

- ❖ **SST** (7)
- **SDT** (7)
- **CFO** (10g)
- **CSO** (10g)

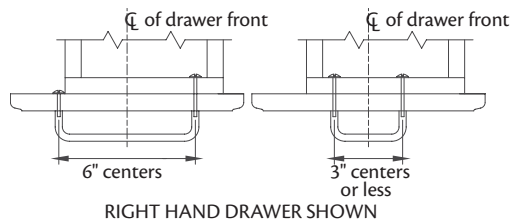

Vanity Sink Base Two Drawer Three Door

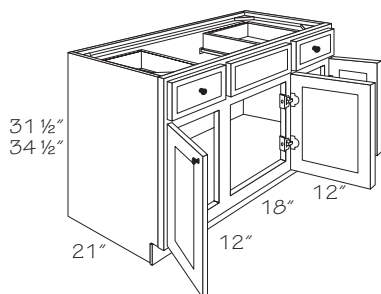

10a

21" Deep
31 1/2" High
VSB42-2D
VSB48-2D
34 1/2" High
VSB4235-2D
VSB4835-2D

- Two standard height top drawers
- Drawer front only between top drawers
- Center door is hinged right
- Center door on 42" cabinets is 6" wider than outer doors
- Center door on 48" cabinets is 3" wider than outer doors
- Back is pre-drilled for optional bottom and mid-height accessory Tray Kits that fit behind outer doors. See tray availability charts in the Trays section
- Space between drawers for sink installation is 21"
- Instructions and hardware included to convert drawers into drawer fronts only for larger vanity bowls

- ❖ **SST** (7)
- **SDT** (7)
- **CFO** (10g)
- **CSO** (10g)

Vanity Sink Base Two Drawer Four Door

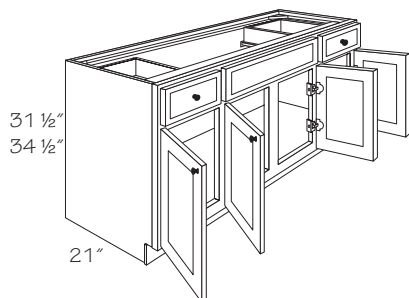

⑩a

21" Deep
31 1/2" High
VSB60-2D
34 1/2" High
VSB6035-2D

- Two standard height top drawers
- Drawer front only between top drawers
- Door left of center hinged left, door right of center hinged right
- Actual cabinet width is 59 1/2", traditional overlay cabinet frame stiles are extended and may be trimmed a maximum of 1/2" each to a cabinet width of 58 1/2"
- Space between drawers for sink installation is 31 3/4"
- Traditional overlay inner doors are 12 5/8" wide and outer doors are 13 1/4" wide. Full overlay inner doors are 14" wide and outer doors are 14 5/8"
- 3 3/16" wide full-width support crossrail across top front of cabinet
- Back is pre-drilled for optional bottom and mid-height accessory Tray Kits that fit behind outer doors. See tray availability charts in the Trays section
- Tray Kits are **not** available for center doors

- ❖ SST ⑦
- SDT ⑦
- CFO ⑩g
- CSO ⑩g

Vanity Combination Drawer Two Drawer

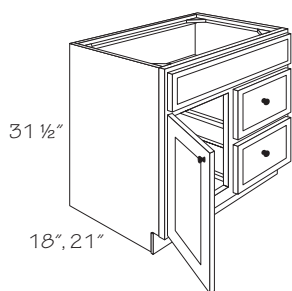

⑩a

Specify DR or DL
18" Deep
31 1/2" High
VCD2418 DR or DL
VCD3018 DR or DL
VCD3618 DR or DL
21" Deep
VCD24 DR or DL
VCD30 DR or DL
VCD36 DR or DL

- One door and one full-width drawer front above door and drawers
- Specify DL (Drawer Left) or DR (Drawer Right) position for drawers
- Back is pre-drilled for optional bottom and mid-height accessory Tray Kits. See tray availability charts in the Trays section

- ❖ SST ⑦
- SDT ⑦
- CFO ⑩g
- CSO ⑩g

Vanity Combination Drawer Three Drawer

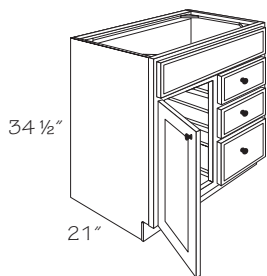

⑩a

Specify DR or DL
21" Deep
34 1/2" High
VCD2435 DR or DL
VCD3035 DR or DL
VCD3635 DR or DL

- One door and one full-width drawer front above door and drawers
- Specify DL (Drawer Left) or DR (Drawer Right) position for drawers
- Back is pre-drilled for optional bottom and mid-height accessory Tray Kits. See tray availability charts in the Trays section

- ❖ SST ⑦
- SDT ⑦
- CFO ⑩g
- CSO ⑩g

Vanity Combination Drawer Six Drawer Single Door

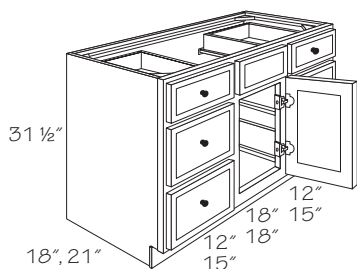

⑩a

18" Deep
31 1/2" High
VCD4218
VCD4818
21" Deep
VCD42
VCD48

- Two standard height top drawers and four deep lower drawers
- Center door is hinged right
- Drawer front only between top drawers
- Space between drawers for sink installation is 21"
- Back is **not** pre-drilled for optional bottom and mid-height accessory Tray Kits
- Instructions and hardware included to convert the top drawers into drawer fronts only for offset or double vanity bowls

- ❖ SST ⑦
- SDT ⑦
- CFO ⑩g
- CSO ⑩g

Vanity Combination Drawer Eight Drawer Single Door

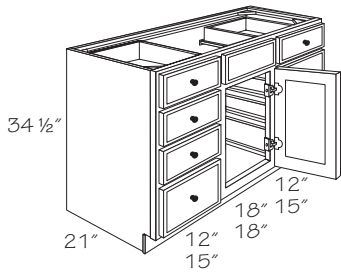

10a
 21" Deep
 34 1/2" High
VCD4235
VCD4835

- Six standard height and two deep drawers
- Center door is hinged right
- Drawer front only between top drawers
- Space between drawers for sink installation is 21"
- Back is **not** pre-drilled for optional roll-out trays

- ❖ SST 7
- SDT 7
- CFO 10g
- CSO 10g

Vanity Combination Drawer Six Drawer Double Door

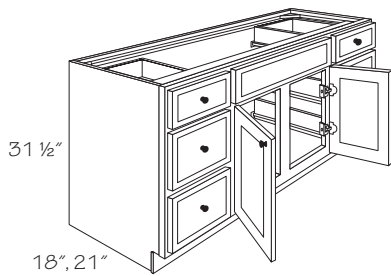

10a
 18" Deep
 31 1/2" High
VCD6018
 21" Deep
VCD60

- Two standard height top drawers and four deep lower drawers
- Drawer front only between top drawers
- Door left of center hinged left, door right of center hinged right
- Actual cabinet width is 59 1/2", traditional overlay cabinet frame stiles are extended and may be trimmed a maximum of 1/2" each to a cabinet width of 58 1/2"
- 3 3/16" wide full-width support crossrail across top front of cabinet
- Space between drawers for sink installation is 31 3/4"
- Accessory Roll-out Trays **not** available
- Instructions and hardware included to convert the top drawer into drawer front only for larger vanity bowls

- ❖ SST 7
- SDT 7
- CFO 10g
- CSO 10g

Vanity Combination Drawer Eight Drawer Double Door

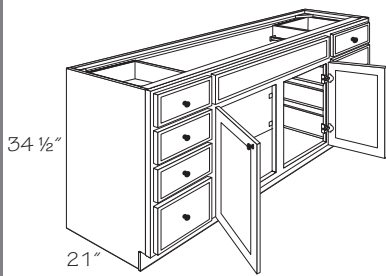

10a
 21" Deep
 34 1/2" High
VCD6035

- Six standard height top drawers and two deep lower drawers
- Drawer front only between top drawers
- Door left of center hinged left, door right of center hinged right
- Actual cabinet width is 59 1/2", traditional overlay cabinet frame stiles are extended and may be trimmed a maximum of 1/2" each to a cabinet width of 58 1/2"
- 3 3/16" wide full-width support crossrail across top front of cabinet
- Space between drawers for sink installation is 31 3/4"
- Accessory Roll-out Trays **not** available
- Instructions and hardware included to convert the top drawers into drawer fronts only for offset or double vanity bowls

- ❖ SST 7
- SDT 7
- CFO 10g
- CSO 10g

Vanity Drawer Three Drawer

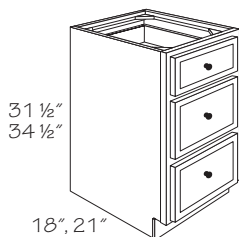

10a
 18" Deep
 31 1/2" High
VD1218-3D
VD1518-3D
VD1818-3D
VD2118-3D
VD2418-3D

10a
 21" Deep
 31 1/2" High
VD12-3D
VD15-3D
VD18-3D
VD21-3D
VD24-3D

34 1/2" High
VD1235-3D
VD1535-3D
VD1835-3D
VD2135-3D
VD2435-3D

- One standard height top drawer and two deep drawers below

- ❖ SST 7
- SDT 7
- CFO 10g
- CSO 10g

Vanity Linen Cabinet Tall

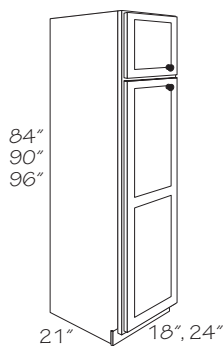

- ⑩a
- ⑩c
- Specify R or L
- 84" Tall
- VLC1884 R or L**
- VLC2484 R or L**
- 90" Tall
- VLC1890 R or L**
- VLC2490 R or L**
- 96" Tall
- VLC1896 R or L**
- VLC2496 R or L**

- Fixed shelf between top and bottom section with adjustable shelves in top section: 84" high-no shelves; 90" high-1 shelf; 96" high-2 shelves
- End panels of bottom section are pre-drilled for optional shelves and accessory Tray Kits
- Interior height of tall section on 84" and 96" tall cabinets is 60 15/16"; 90" tall is 61 7/16"
- 96" high cabinets include toe kick platform shipped unattached for easier handling and installation
- Bottom, tall doors are two-piece panel construction, except Arbor Falls Express, which has a single raised panel profile
- Toe kick cover required on exposed sides of toe kick platform

- ❖ SST ⑦
- ❖ SDT ⑦
- CFO ⑩g
- CSO ⑩g

Vanity Wall Boutique - 7" Deep

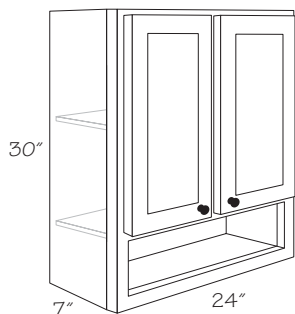

- ⑩a
- VWB2430B**

- One adjustable shelf
- Exposed full-depth fixed shelf in lower section
- No towel bar
- Matching color laminate interior and shelves
- Back panel has vertical grain except for painted finishes
- 5" high frame opening in lower section
- Cabinets have BUTT doors without a frame center stile
- Cabinet back extends through opening in lower section

- ❖ SST ⑦
- ❖ SDT ⑦
- CFO ⑩g
- CSO ⑩g

Vanity Wall - 4 3/4" Deep

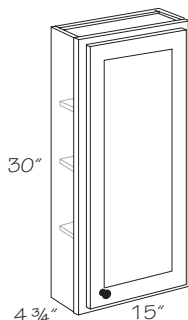

- ⑩a
- ⑩c
- Specify R or L
- VW1530 R or L**

- Three adjustable shelves
- For surface mount installation

- ❖ SST ⑦
- ❖ SDT ⑦
- CFO ⑩g
- CSO ⑩g

Medicine Cabinet

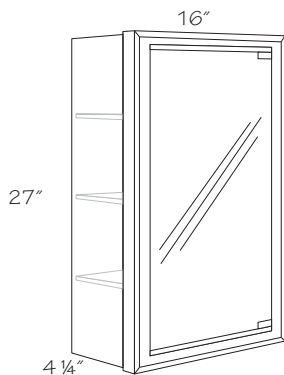

- ⑩a
- MC1627**

Cutout dimensions for recessed installation

Item	Width	Height	Depth
MC1627	14 1/2"	25 3/4"	3 1/2"

- For surface mount or recess installation
- Door is 3/16" thick plate glass mirror with rounded edges with pivot hinges, magnetic touch latch and vinyl safety backer
- Three adjustable 5/8" thick no-tilt shelves with clear shelf supports
- Hinged right
- Cabinet can be inverted, magnetic latch **must** be relocated
- Solid wood frame has profile on all four outside edges complementing; Seneca Ridge Express and Spring Valley Express door styles
- Maple laminate interior
- Available in all finishes, except Maple Accent Glaze shipped standard finish
- Available in all painted finishes, which are painted hardwood
- Mounting hardware included
- Mirror door shipped unattached for easier handling and installation

- ❖ SST ⑦
- ❖ SDT ⑦
- CFO ⑩g
- CSO ⑩g

Tri-View Medicine Cabinet

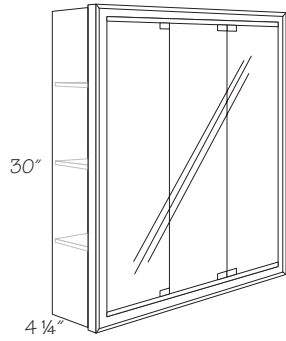

Cutout dimensions for recessed installation

Item	Width	Height	Depth
TVMC2430	22 3/4"	28 3/4"	3 1/2"
TVMC3030	28 3/4"	28 3/4"	3 1/2"
TVMC3630	34 3/4"	28 3/4"	3 1/2"

⑩a
TVMC2430
TVMC3030
TVMC3630

- For surface mount or recess installation **SST** ⑦
- Three adjustable 5/8" thick no-tilt shelves with clear shelf supports **SDT** ⑦
- Doors are 3/16" thick plate glass mirror with rounded edges, pivot hinges, magnetic touch latch and vinyl safety backer **CFO** ⑩g
- Left and center doors hinged right, right door hinged left to create a three-way reflection **CSO** ⑩g
- Vertical divider between center and left hand door in 30" and 36" cabinet
- Solid wood frame has profile on all four outside edges complementing Seneca Ridge Express and Spring Valley Express door styles
- Available in all finishes
- Available in all painted finishes, which are painted hardwood
- Mirror door shipped unattached for easier handling and installation
- Mounting hardware included

Vanity Accessories

HW	Hardwood	-----	(2)
MP	Maple	-----	(2)
RO	Red Oak	-----	(2)
TH	Thermofoil	-----	(2)

Construction Options and Modifications

- ❖ Included as standard
 - Available with an upcharge
 - ☆ Available with exceptions
- (Blank) **Not** available

(10a)

MBEP2131

Vanity Filler

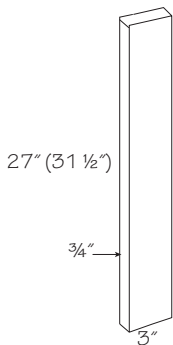

(10a)
VF3

- 3/4" thick solid wood
- Backside of filler **not** finished
- Available in all finishes; Maple Accent Glaze shipped standard finish
- Available in all painted finishes, which are painted hardwood
- One per carton

❖	HW	(2)
❖	MP	(2)
❖	RO	(2)
❖	TH	(2)

Tall Filler

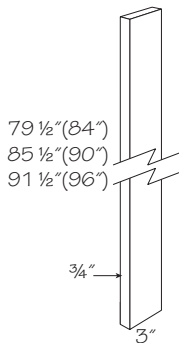

(10a)
TF3-84
TF3-90
TF3-96

- 3/4" thick solid wood
- Backside of filler **not** finished
- Available in all finishes; Maple Accent Glaze shipped standard finish
- Available in all painted finishes, which are painted hardwood
- One per carton

❖	HW	(2)
❖	MP	(2)
❖	RO	(2)
❖	TH	(2)

Toe Kick Cover - Laminate

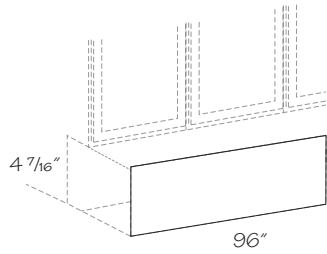

⑩a
1/8" Thick
TKCL8

- Matching easy clean laminate on one side
- Grain direction runs lengthwise (when applicable)
- Available in all finishes; Maple Accent Glaze shipped standard finish
- Offered in individual 8' lengths

❖ HW ②
❖ MP ②
❖ RO ②
❖ TH ②

Toe Kick Cover - Veneer

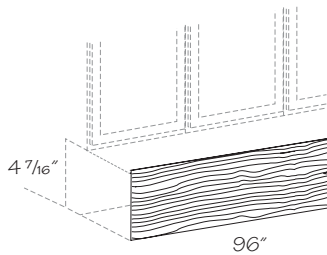

⑩a
5/32" Thick
TKCV8

- Matching wood veneer plywood finished on one side, grain direction runs lengthwise
- Available in all finishes; Maple Accent Glaze shipped standard finish
- Offered in individual 8' lengths

❖ HW ②
❖ MP ②
❖ RO ②
❖ TH ②

Matching Vanity End Panel

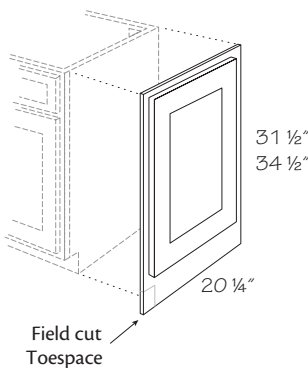

⑩a
MVEP2131
MVEP2135

- Provides a finished furniture look to vanity cabinet ends
- Includes end panel with decorative door
- For right or left hand use
- 5/32" thick veneered plywood panel, except Arbor Falls Express
- 3/16" thick white laminate panel for Arbor Falls Express
- Available in all door styles and finishes
- Full overlay door styles shipped unattached to panel. When installed, door overlaps cabinet frame edge to provide matching reveals
- Traditional overlay door styles; door shipped attached to panel
- Available in all painted finishes, which are painted hardwood
- Toospace notch **must** be field cut
- One per carton

❖ HW ②
❖ MP ②
❖ RO ②
❖ TH ②

Item	Panel Size		Full Overlay		Partial Overlay	
	Width	Height	Width	Height	Width	Height
MVEP2131	20 1/4"	31 1/2"	20 5/8"	26 1/4"	19 1/4"	25"
MVEP2135	20 1/4"	34 1/2"	20 5/8"	29 1/4"	19 1/4"	28"

Notes

Office Cabinets

SST Construction	-----	(7)
SDT Construction	-----	(7)
CFO Cabinet Front Only	-----	(10g)
CSO Case Only	-----	(10g)

Construction Options and Modifications

- ❖ Included as standard
- Available with an upcharge
- ☆ Available with exceptions

(Blank) **Not** available

(10a)

DKD3018

Desk Knee Drawer

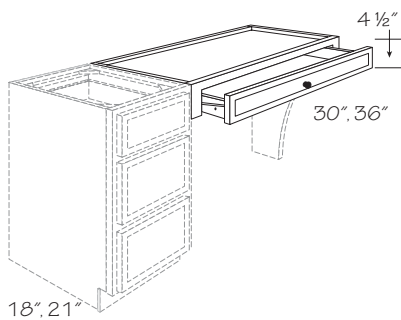

(10a)

18" deep
DKD3018
DKD3618

21" deep
DKD30
DKD36

- Designed for use between base, desk, vanity, tall cabinets or with desk leg on one end
- Full-width top panel is recessed for easier installation
- Drawer front is profiled on all edges
- Traditional overlay door styles; face frame stiles may be trimmed a maximum 3/4" each allowing the DKD width to be reduced a maximum of 1 1/2"
- Full overlay door styles; face frame stiles are **not** trimmable
- Drawer fronts are solid slab; except Ralston Express
- Ralston Express drawer fronts are same construction as standard fronts; except the stiles and rails are narrower (1 1/2" wide)
- Requires countertop or writing surface

❖ SST	(7)
● SDT	(7)
● CFO	(10g)
● CSO	(10g)

Office Cabinet Accessories

HW	Hardwood	-----	(2)
MP	Maple	-----	(2)
RO	Red Oak	-----	(2)
TH	Thermofoil	-----	(2)

Construction Options and Modifications

- ❖ Included as standard
 - Available with an upcharge
 - ☆ Available with exceptions
- (Blank) **Not** available

(10a)

DEP2431

Desk End Panel

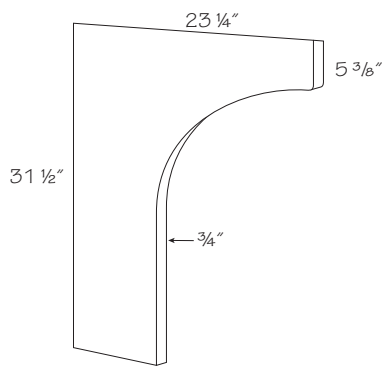

(10a)

DEP2431

- Used to support end of Desk Knee Drawer (DKD). Fits behind extended frame stile
- 3/4" thick engineered wood core (SST) with vertical grain veneer on both sides and front edge for Hardwood, Maple and Oak
- Available in all finishes; Maple Accent Glaze shipped standard finish
- Available in all painted finishes, which are painted hardwood
- Field cut to correct height where applicable
- One per carton

❖	HW	(2)
❖	MP	(2)
❖	RO	(2)
❖	TH	(2)

Panels

Construction Options and Modifications

- ❖ Included as standard
- Available with an upcharge
- ☆ Available with exceptions

(Blank) **Not** available

(10a)

PB4896P

HW	Hardwood	-----	(2)
MP	Maple	-----	(2)
RO	Red Oak	-----	(2)
TH	Thermofoil	-----	(2)

Panel Backer-Paper

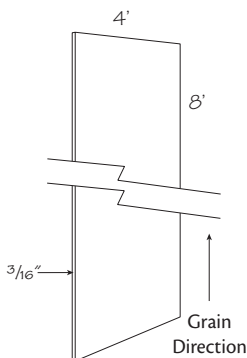

(10a)

PB4896P
PB4896P-2

- Use to cover exposed backs of Base and Tall cabinets in peninsula or island configurations
- Medium Density Fiberboard (MDF) panel with easy clean laminate on front side and unfinished backside
- Accent glaze shipped as standard finish
- Available in all painted finishes, which are painted hardwood
- Painted glazes are shipped as standard finish
- Offered individually or two per carton

❖ HW	(2)
❖ MP	(2)
❖ RO	(2)
❖ TH	(2)

Panel Backer-Veneer

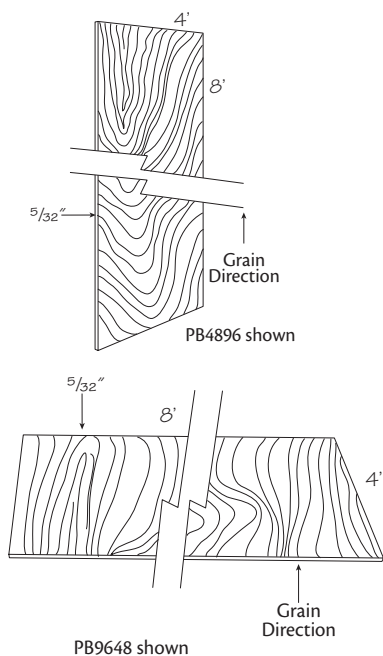

(10a)

4' x 8' Veneer
PB4896
PB4896-2
8' x 4'
PB9648
PB9648-2

- Use to cover exposed backs of Base and Tall cabinets in peninsula or island configurations
- Veneered plywood panel finished on one side
- Accent glaze shipped as standard finish
- PB9648 and PB9648-2 are **not** available in Cotton and Chiffon
- Painted glazes are shipped as standard finish
- Offered individually or two per carton

❖ HW	(2)
❖ MP	(2)
❖ RO	(2)
TH	(2)

CoreGuard® Panel Backer

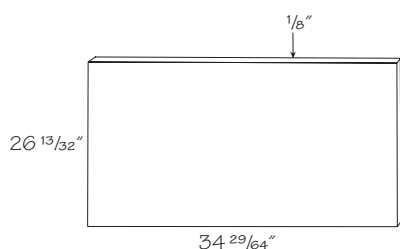

(10a)

CGPB36

- Light beige engineered polymer
- Used to patch backs of CoreGuard® cabinets
- One per carton

HW	(2)
MP	(2)
RO	(2)
TH	(2)

Shelving

Construction Options and Modifications

- ❖ Included as standard
 - Available with an upcharge
 - ☆ Available with exceptions
- (Blank) **Not** available

HW	Hardwood	-----	②
MP	Maple	-----	②
RO	Red Oak	-----	②
TH	Thermofoil	-----	②

⑩a

USK1812-3/4

Shelf Kits

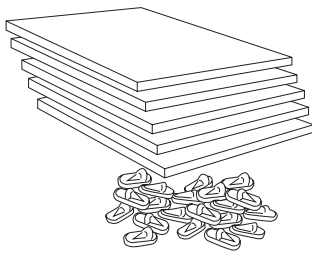

⑩a

Utility Shelf Kit
10 19/32" deep

USK1812-3/4	16 1/4" wide
USK2412-3/4	22 1/4" wide
USK3012-3/4	28 1/4" wide

22 19/32" deep

USK1824-3/4	16 1/4" wide
USK2424-3/4	22 1/4" wide
USK3024-3/4	28 1/4" wide

Vanity Shelf Kit
19 19/32" deep

VLSK1821-3/4	16 1/4" wide
VLSK2421-3/4	22 1/4" wide

- Easy to clean natural woodgrain laminated on both sides with matching edge banding on front edge
- 3/4" thick engineered wood shelves laminated on both sides with matching edge banding on the front edge, except USK3012-3/4
- USK3012-3/4 and USK3624-3/4 are 3/4" thick plywood shelves laminated on both sides with matching edge banding on front edge. Includes back supports
- Utility Shelf Kit 10 19/32" deep for use in bottom section of 12" deep utility cabinets.
- Utility Shelf Kit 22 19/32" deep for use in bottom section of 24" deep utility cabinets.
- Vanity Shelf Kit 19 19/32" deep for use in bottom section of 21" Vanity Linen Cabinets
- Cabinet end panels are pre-drilled
- Kit includes: five shelves, 20 clear supports, 30" wide shelf kits also include five clear back supports

❖	HW	②
❖	MP	②
❖	RO	②
❖	TH	②

Trays

Construction Options and Modifications

Note: Determine the location of plumbing and other obstructions before ordering any tray kits

10a

BTK12

Base Tray Kit - Standard

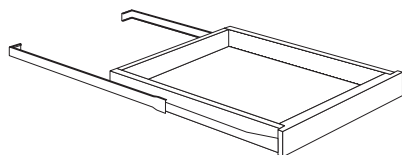

10a

- BTK12**
- BTK15**
- BTK18**
- BTK21**
- BTK24**
- BTK27B**
- BTK30B**
- BTK33B**
- BTK36B**
- BTK39**
- BTK45**

- Installs in 24" deep Base and Utility cabinets only using pre-drilled holes in back panels. Base cabinets utilize holes in the back panel; Utility cabinets utilize holes in the end panels
- Includes tray core box, 3/4 extension left and right slides and installation hardware
- BTK15, BTK18, BTK24, BTK30B and BTK36B include brackets and screws for installing in Utility Cabinets (U), utilizing pre-drilled holes in cabinets and end panels
- Tray front made of solid hardwood; tray sides, back and bottom panel are made of engineered wood covered with a moisture- and stain-resistant, easy clean laminate. Top edge of sides and back finished with matching edge banding
- One tray per kit

Item	Tray Width	For Use In:
BTK12	8 3/4"	B12, B12FH, SB12, UB12
BTK15	11 3/4"	B15, B15FH, SB15
BTK18	14 3/4"	B18, B18FH, SB18, U188424, U189024, U189624
BTK21	17 3/4"	B21, B21FH, B42, B42FH, SB21, SB42
BTK24	20 3/4"	B24, B24B, B24FH, B24BFH, PBBC24/27, PBBC24/27B, B48, B48FH, SB24, SB24B, SB24FH, SB24BFH, SB48FH, U248424, U249024
BTK27B	23 1/4"	B27B, B27BFH, SB27B, SB27BFH
BTK30B	26 1/4"	B30B, B30BFH, SB30B, SB30BFH, U308424B, U309024B
BTK33B	29 3/4"	B33B, B33BFH, SB33B
BTK36B	32 3/4"	B36B, B36BFH, SB36B, SB36BFH
BTK39	16 1/4"	B39, B39FH, BBC45/48, SB39
BTK45	19 1/4"	B45, B45FH, BBC48/51

Base Tray Kit - Double Faced, Standard

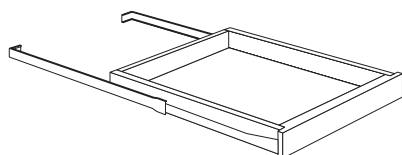

10a

- BTK18DF**
- BTK21DF**
- BTK24DF**
- BTK27BDF**
- BTK30BDF**
- BTK36BDF**

- Installs in Peninsula Base (PB) cabinets
- Tray front is made of solid hardwood; tray sides, back and bottom panel are made of engineered wood covered with a moisture and stain-resistant, easy clean laminate. Top edge of sides and back finished with matching edge banding
- Includes tray core box, 3/4 extension left and right slides and installation hardware
- One tray per kit

Grey color coding indicates new product, size or code.

Item	Tray Width	For Use In:
BTK18DF	14 3/4"	PB18
BTK21DF	17 3/4"	PB21
BTK24DF	20 3/4"	PB24, PB24B
BTK27BDF	23 3/4"	PB27B
BTK30BDF	26 3/4"	PB30B
BTK36BDF	32 3/4"	PB36B

Vanity Tray Kit

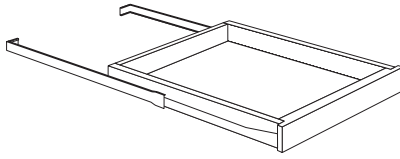

(10a)

VTK12
VTK15
VTK18
VTK21
VTK24
VTK30B
VTK36B

- Installs in 21" deep Vanity cabinets only, using pre-drilled holes in back panel
- Includes tray core box, 3/4 extension left and right slides and installation hardware
- Tray front is made of solid hardwood; tray sides, back and bottom panel are made of engineered wood covered with a moisture and stain-resistant, easy clean laminate. Top edge of sides and back finished with matching edge banding
- VTK15, VTK18 and VTK24 includes brackets and screws for installing in tall Vanity Linen (VLC) cabinets utilizing pre-drilled holes in the end panels
- One tray per kit

Item	Tray Width	For Use In:
VTK12	8 3/4"	VB12, VB1235, VB60FH, VCD24DR/L, VCD2435DR/L, VSB42-2D, VSB4235-2D
VTK15	11 3/4"	VB15, VB1535, VB48FH, VB4835FH, VCD30DR/L, VCD3035DR/L, VSB48-2D, VSB4835-2D, VSB60-2D VSB6035-2D
VTK18	14 3/4"	VB18, VB1835, VB18FH, VB1835FH, VB48FH, VB4835FH, VCD36DR/L, VCD3635DR/L, VCD42, VCD4235, VCD48, VCD4835, VLC1884, VLC1890, VLC1896, VSB36-2D, VSB3635-2D, VSB42-2D, VSB4235-2D, VSB48-2D, VSB4835-2D
VTK21	17 3/4"	VB21, VB2135, VB21FH, VB2135FH, VB42FH, VB4235FH, VSB42, VSB4235
VTK24	20 3/4"	VB2435, VB24B, VB2435B, VB2435BFH, VB245FH, VB2435SFH, VLC2484, VLC2490, VLC2496, VSB2435B
VTK30B	26 3/4"	VB30BFH, VB3035BFH, VSB30B, VSB3035B
VTK36B	32 3/4"	VB36BFH, VB3635BFH, VSB36B, VSB3635B

Vanity Tray Kit - Space Saver

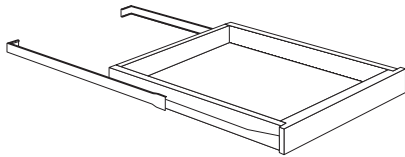

(10a)

VTKS12
VTKS15
VTKS18
VTKS21
VTKS24
VTKS30B
VTKS36B

- Installs in 18" deep vanity space saver cabinets only, using pre-drilled holes in back panel
- Includes tray core box, 3/4 extension left and right slides and installation hardware
- Tray front is made of solid hardwood; tray sides, back and bottom panel are made of engineered wood covered with a moisture and stain-resistant, easy clean laminate. Top edge of sides and back finished with matching edge banding
- One tray per kit

Grey color coding indicates new product, size or code.

Item	Tray Width	For Use In:
VTKS12	8 3/4"	VB6018FH, VCD2418DR/L
VTKS15	11 3/4"	VB303518FH, VB4818FH, VCD3018DR/L
VTKS18	14 3/4"	VB1818FH, VB363518FH, VCD3618DR/L
VTKS21	17 3/4"	VB2118FH, VB4218FH
VTKS24	20 3/4"	VB243518SFH
VTKS30B	26 3/4"	VB3018BFH, VB303518BFH
VTKS36B	32 3/4"	VB3618BFH, VB363518BFH

Roll-Out Trays - Solid Wood

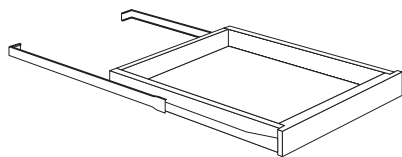

10a

Vanity Cabinets 18" Deep

- ROT1518**
- ROT1818**
- ROT2418B**
- ROT3018B**

Vanity Cabinets 21" Deep

- ROT1221**
- ROT1521**
- ROT1821**
- ROT2121**
- ROT2421B**
- ROT3021B**
- ROT3621B**

Base Cabinets 24" Deep

- ROT1224**
- ROT1524**
- ROT1824**
- ROT2124**
- ROT2424B**
- ROT2724B**
- ROT3024B**
- ROT3324B**
- ROT3624B**
- ROT3924**
- ROT4524**

- Installs in Base, Utility, Vanity and Vanity Space Saver cabinets utilizing pre-drilled holes in the back panel. Base, Utility, Vanity and Vanity Space Saver cabinets utilize holes in the back panel; Utility cabinets utilize holes in the end panels
- Includes tray core box, 3/4 extension left and right slides and installation hardware
- 3/16" thick plywood bottom panel finished on the top side with a moisture and stain resistant, easy clean laminate with printed matching wood grain
- Solid hardwood tray core with 3/4" thick front and 1/2" thick sides and back
- ROT1524, ROT1824, ROT2424B, ROT3024B, and ROT3624B include brackets and screws for installing in 24" deep Utility (U) cabinets utilizing pre-drilled holes in both end panels
- ROT1521, ROT1821 and ROT2421B include brackets and screws for installing in 21" deep tall Vanity Linen Cabinets (VLC) utilizing pre-drilled holes in both end panels
- Natural finish
- One tray per kit

Item (by depth)	Tray Width	For Use In:
18" depth		
ROT1518	11 3/4"	VB4818FH, VB6018FH, VCD3018DR/L
ROT1818	14 3/4"	VB1818FH, VB4818FH, VCD3618DR/L
ROT2418	20 3/4"	VB243518BFH, VB243518SFH
ROT3018	26 3/4"	VB3018BFH, VB303518BFH
21" Deep		
ROT1221	8 3/4"	VB12, VB1235, VCD24DR/L, VCD2435DR/L, VSB42-2D, VSB4235-2D
ROT1521	11 3/4"	VB15, VB1535, VB4835FH, VB60FH, VCD30DR/L, VCD3035DR/L, VSB48-2D, VSB4835-2D, VSB60-2D, VSB6035-2D
ROT1821	14 3/4"	VB18, VB18FH, VB1835, VB1835FH, VB48FH, VB4835FH, VCD36DR/L, VCD3635DR/L, VCD42, VCD4235, VCD48, VCD4835, VLC1884, VLC1890, VLC1896, VSB36-2D, VSB3635-2D, VSB42-2D, VSB4235-2D, VSB48-2D, VSB4835-2D
ROT2121	17 3/4"	VB21, VB2135, VB21FH, VB2135FH, VB42FH, VB4235FH, VSB42, VSB4235
ROT2421	20 3/4"	VB2435, VB2435B, VB2435BFH, VB24SFH, VB2435SFH, VLC2484, VLC2484B, VLC2490, VLC2496, VSB2435B
ROT3021B	26 3/4"	VB30BFH, VB3035BFH, VSB30B, VSB3035B
ROT3621B	32 3/4"	VB36BFH, VB3635BFH, VSB36B, VSB3635B
24" Deep		
ROT1224	8 3/4"	B12, B12FH, SB12
ROT1524	11 3/4"	B15, B15FH, SB15
ROT1824	14 3/4"	B18, B18FH, SB18, U188424, U189024, U189624
ROT2124	17 3/4"	B21, B21FH, B42, B42FH, SB21, SB42
ROT2424B	20 3/4"	B24, B24B, B24FH, B24BFH, PBBC24/27, PBBC24/27B, B48, B48FH, SB24, SB24B, SB24FH, SB24BFH, SB48, U248424, U249024, U249624
ROT2724B	23 3/4"	B27B, B27BFH, SB27B, SB27BFH
ROT3024B	26 3/4"	30B, B30BFH, SB30B, SB30BFH, U308424B, U309024B, U309624B
ROT3324	13 1/4"	BBC42/45, SB33,
ROT3324B	29 3/4"	B33B, B33BFH, SB33B, SB33BFH
ROT3624B	32 3/4"	B36B, B36BFH, SB36B, SB36BFH
ROT3924	16 1/4"	B39, B39FH, BBC45/48, SB39
ROT4524	19 1/4"	B45, B45FH, BBC48/51

Notes

Supports and Valances

Construction Options and Modifications

- ❖ Included as standard
- Available with an upcharge
- ☆ Available with exceptions

(Blank) **Not** available

HW	Hardwood	-----	(2)
MP	Maple	-----	(2)
RO	Red Oak	-----	(2)
TH	Thermofoil	-----	(2)



Countertop Support Bracket

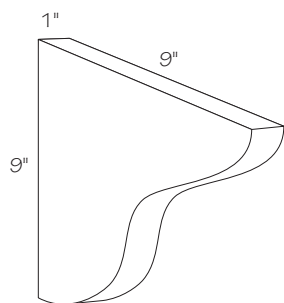

- Solid wood
- Vertical wood grain
- For use as additional shelf or countertop support
- Available in all finishes
- Available in all painted finishes, which are painted hardwood
- Includes 2 recessed metal keyhole brackets installed on backside
- Mounting hardware included
- Two per carton

❖ HW	(2)
❖ MP	(2)
❖ RO	(2)
❖ TH	(2)

Valance Traditional

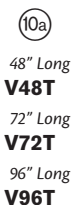
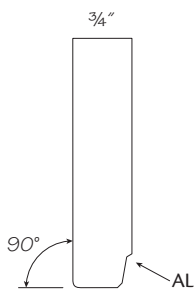
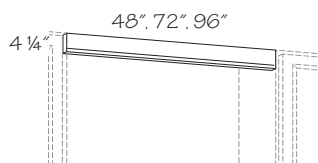

- Solid wood
- For use between wall cabinets over windows as a panel to conceal light fixtures
- Front and back sides are finished
- Profiled edge
- Available in all painted finishes, which are painted hardwood
- Backside **not** intended to be viewed
- Available in all finishes
- Maple Accent Glaze has one accent line (AL) on front profile
- One per carton
- **Note:** White has no profiled edges for a more contemporary look. **Not** shown

❖ HW	(2)
❖ MP	(2)
❖ RO	(2)
❖ TH	(2)

Moldings

Construction Options and Modifications

HW	Hardwood	-----	(2)
MP	Maple	-----	(2)
RO	Red Oak	-----	(2)
TH	Thermofoil	-----	(2)

- ❖ Included as standard
- Available with an upcharge
- ☆ Available with exceptions

(Blank) **Not** available

(10a)
ICM8

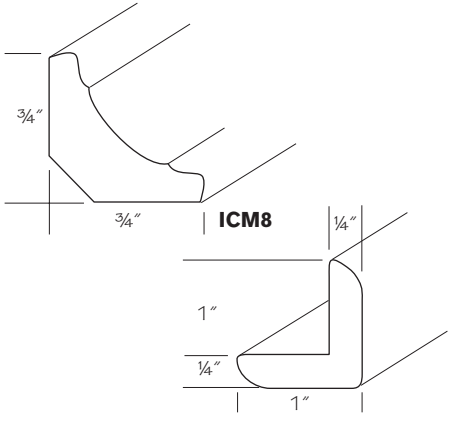

Corner Molding

(10a)
Inside Corner Molding
ICM8
Outside Corner Molding
OSC8

- Solid wood
- Available in all finishes in Oak and Maple including Chiffon, Cotton and White
- **Not** available in Maple Accent Glaze
- Available in all painted finishes, which are painted hardwood
- Backs **not** finished
- Molding will be solid wood and match the colors of hardwood, maple and oak finishes
- Offered in individual 8' lengths

❖	HW	(2)
❖	MP	(2)
❖	RO	(2)
❖	TH	(2)

OSC8

Countertop Molding - Decorative Edge

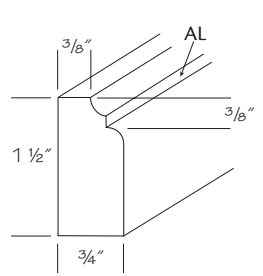

(10a)
CTD8

- Solid wood
- Backs **not** finished
- Available in all finishes
- Used as countertop nosing
- Can be used under wall cabinets to conceal light fixtures
- Maple Accent Glaze has one accent line (AL) on front profile
- Moldings in painted finishes and painted finishes with glazes are painted hardwood
- Molding will be solid wood and match the colors of hardwood, maple and oak finishes
- Offered in individual 8' lengths

❖	HW	(2)
❖	MP	(2)
❖	RO	(2)
❖	TH	(2)

Angle Crown Molding

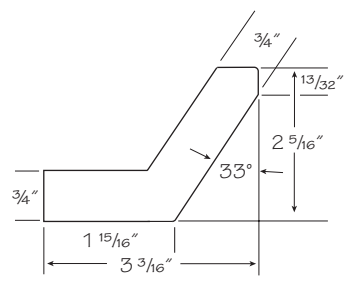

(10a)
ACM8

- Solid wood
- Installs directly to top of cabinet
- Allow sufficient space between top of cabinet and soffit or ceiling to accommodate molding
- Available in all painted finishes, which are painted hardwood
- Available in all finishes, except Maple Accent Glaze shipped standard finish
- For use with traditional or full overlay door styles
- Molding will be solid wood and match the colors of hardwood, maple and oak finishes
- Offered in individual 8' lengths

❖	HW	(2)
❖	MP	(2)
❖	RO	(2)
❖	TH	(2)

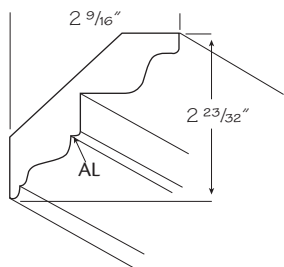

Classic Crown Molding

⑩a
8' length
CCM8
10' length
CCM-SW10

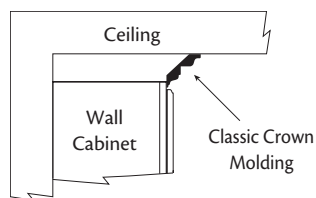

- Solid wood
- Available in all finishes
- Backs **not** finished
- Allow sufficient space between top of cabinet and soffit or ceiling to accommodate molding
- Includes recess for the application of Single Bead Trim Molding (SBT8)
- Maple Accent Glaze has one accent line (AL) on front profile
- Moldings in painted finishes and painted finishes with glazes are painted hardwood
- Molding will be solid wood and match the colors of hardwood, maple and oak finishes
- Offered in individual 8' or 10' lengths

- ❖ HW ②
- ❖ MP ②
- ❖ RO ②
- ❖ TH ②

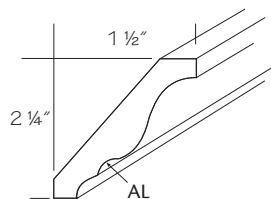

Crown Molding

⑩a
8' length
CM8
10' length
CM-SW10

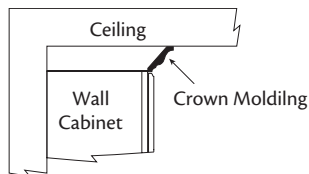

- Solid wood
- Available in all finishes
- Backs **not** finished
- Allow sufficient space between top of cabinet and soffit or ceiling to accommodate molding
- Maple Accent Glaze has one accent line (AL) on front profile
- Moldings in painted finishes and painted finishes with glazes are painted hardwood
- Molding will be solid wood and match the colors of hardwood, maple and oak finishes
- Offered in individual 8' or 10' lengths

- ❖ HW ②
- ❖ MP ②
- ❖ RO ②
- ❖ TH ②

New

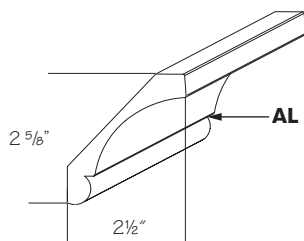

Cove Molding

⑩a
■ **CVLM8**
■ Painted or Stained plywood supplied for laminate door styles

Grey color coding indicates new product, size or code.

CVLM8

- Solid wood
- Available in all finishes
- Back **not** finished
- Allow sufficient space between top of cabinet and soffit or ceiling to accommodate molding
- Maple Accent Glaze has one accent line (AL) on front profile
- Molding will be solid wood and match the colors of hardwood, maple and oak finishes
- Moldings in painted finishes and painted finishes with glazes are painted hardwood
- Offered in individual 8' lengths

- ❖ HW ②
- ❖ MP ②
- ❖ RO ②
- ❖ TH ②

New

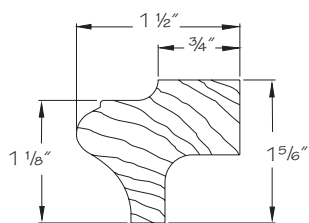

Cove Light Rail Molding

⑩a
CVLR8
Grey color coding indicates new product, size or code.

CVLR8

- Solid wood
- Can be used under wall cabinets to conceal light fixtures
- All surfaces finished
- Available in all finishes, except Maple Accent Glaze shipped standard finish
- Molding will be solid wood and match the colors of hardwood, maple and oak finishes
- Moldings in painted finishes and painted finishes with glazes are painted hardwood
- Offered in individual 8' lengths

- ❖ HW ②
- ❖ MP ②
- ❖ RO ②
- ❖ TH ②

Soffit Crown Molding

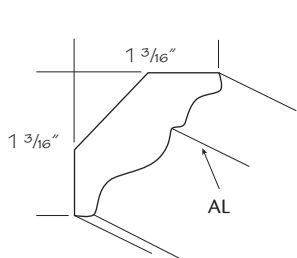

⑩a
SCM8

- Solid wood
- Available in all finishes
- Backs **not** finished
- Allow sufficient space between top of cabinet and soffit or ceiling to accommodate molding
- Maple Accent Glaze has one accent line (AL) on front profile
- Moldings in painted finishes and painted finishes with glazes are painted hardwood
- Molding will be solid wood and match the colors of hardwood, maple and oak finishes
- Offered in individual 8' lengths

❖ HW ②
❖ MP ②
❖ RO ②
❖ TH ②

Traditional Furniture Base

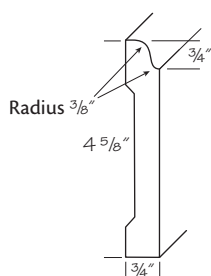

⑩a
TFB8

- Solid wood
- Backs **not** finished
- Available in all finishes; Maple Accent Glaze shipped standard finish
- Available in all painted finishes, which are painted hardwood
- Molding will be solid wood and match the colors of hardwood, maple and oak finishes
- Offered in individual 8' lengths

❖ HW ②
❖ MP ②
❖ RO ②
❖ TH ②

Narrow Batten Molding

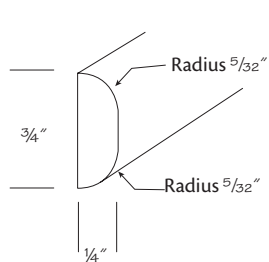

⑩a
NBM8

- Solid wood
- Backs **not** finished
- Available in all finishes, except Maple Accent Glaze shipped standard finish
- Available in all painted finishes, which are painted hardwood
- Molding will be solid wood and match the colors of hardwood, maple and oak finishes
- Offered in individual 8' lengths

❖ HW ②
❖ MP ②
❖ RO ②
❖ TH ②

Quarter Round Molding

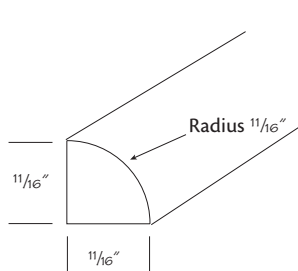

⑩a
QR8

- Solid wood
- Can be used to trim between toe kick and floor
- Backs **not** finished
- Available in all finishes; Maple Accent Glaze shipped standard finish
- Available in all painted finishes, which are painted hardwood
- Moldings may be shipped with the back corner mitered off
- Molding will be solid wood and match the colors of hardwood, maple and oak finishes
- Offered in individual 8' lengths

❖ HW ②
❖ MP ②
❖ RO ②
❖ TH ②

Scribe Molding

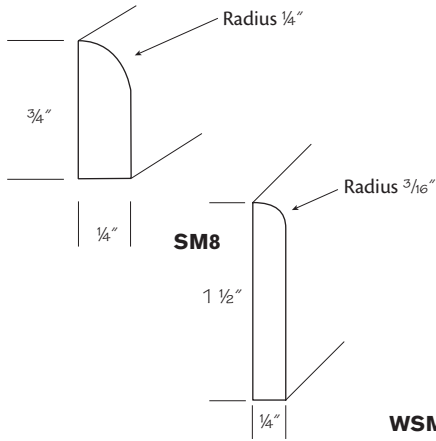

⑩a
Scribe Molding
SM8
Wide Scribe Molding
WSM8

- Solid wood
- Available in all finishes in Hardwood, Maple and Oak. Maple Accent Glaze shipped standard finish
- Available in all painted finishes, which are painted hardwood
- SM8 **not** finished on bottom or backside
- WSM8 **not** finished on back side
- Molding will be solid wood and match the colors of hardwood, maple and oak finishes
- Offered in individual 8' lengths

❖ HW ②
❖ MP ②
❖ RO ②
❖ TH ②

Shoe Molding

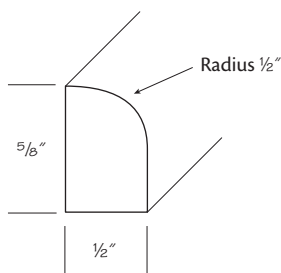

⑩a
SHO8

- Solid wood
- Used as inside corner molding or trim between toe kick and floor
- Backs **not** finished
- Available in all finishes; Maple Accent Glaze shipped standard finish
- Available in all painted finishes, which are painted hardwood
- Molding will be solid wood and match the colors of hardwood, maple and oak finishes
- Offered in individual 8' lengths

❖ HW ②
❖ MP ②
❖ RO ②
❖ TH ②

Single Bead Trim

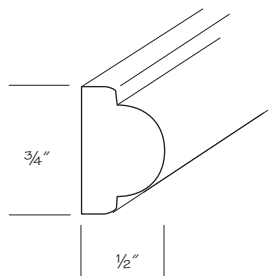

⑩a
SBT8

- Solid wood
- Available in all finishes; Maple Accent Glaze shipped standard finish
- Available in all painted finishes, which are painted hardwood
- Backs **not** finished
- Used to trim front edge of panels. Can also be combined with Classic Crown Molding (CCM8)
- Molding will be solid wood and match the colors of hardwood, maple and oak finishes
- Offered in individual 8' lengths

❖ HW ②
❖ MP ②
❖ RO ②
❖ TH ②

Solid Wood Stock

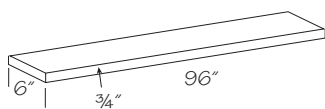

⑩a
SWS8

- 3/4" thick solid wood
- Grain direction runs lengthwise
- Can be used for valance, filler, shelf or other matching finish, cut-to-size applications
- Finished on both sides and both long edges
- Available in all painted finishes, which are painted hardwood
- Molding will be solid wood and match the colors of hardwood, maple and oak finishes
- Offered in individual 8' lengths

❖ HW ②
❖ MP ②
❖ RO ②
❖ TH ②

Large Starter Molding

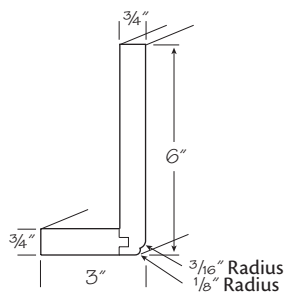

⑩a
LSTR8

- Solid wood
- Used at top of wall and tall cabinets to allow attachment of crown molding or as a filler between cabinet and ceiling/soffit
- Shipped in one piece
- Backs **not** finished
- Available in all finishes, except Maple Accent Glaze shipped standard finish
- Available in all painted finishes, which are painted hardwood
- Molding will be solid wood and match the colors of hardwood, maple and oak finishes
- Offered in individual 8' lengths

- ❖ HW ②
- ❖ MP ②
- ❖ RO ②
- ❖ TH ②

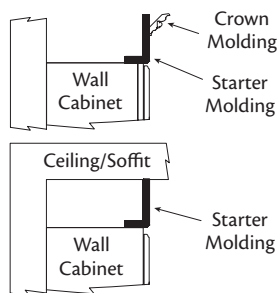

Under Cabinet Molding

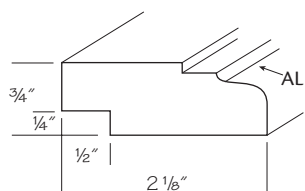

⑩a
UCM8

- Solid wood
- Can be used under wall cabinets to conceal light fixtures
- Can be used for full or traditional overlay applications
- Profile complements most door styles
- All surfaces finished
- Available in all finishes
- Maple Accent Glaze has one accent line (AL) on front profile
- Moldings in painted finishes and painted finishes with glazes are painted hardwood
- Can be combined with Panel Backer (PB) or Wall End Panel (WEP) to create a flush color-matched underside
- Molding will be solid wood and match the colors of hardwood, maple and oak finishes
- Offered in individual 8' lengths

- ❖ HW ②
- ❖ MP ②
- ❖ RO ②
- ❖ TH ②

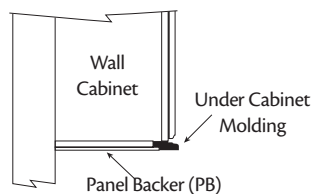

Hardware - Knobs

Construction Options and Modifications

White Ceramic Knob

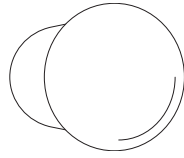

(10a)

**HK02
HK02-100**

Satin Nickel Rope Knob

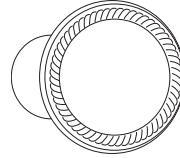

(10a)

**HK107
HK107-100**

Solid Bright Brass Knob

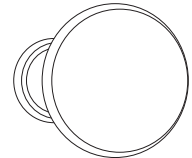

(10a)

**HK108
HK108-100**

Satin Nickel Knob

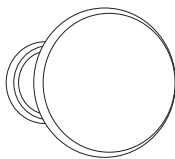

(10a)

**HK109
HK109-100**

Black Nickel Knob

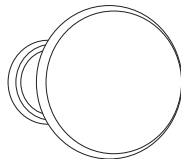

(10a)

**HK110
HK110-100**

Bright Chrome Knob

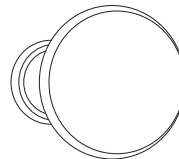

(10a)

**HK111
HK111-100**

Satin Aluminum Knob

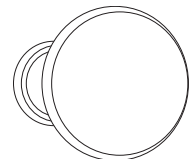

(10a)

**HK117
HK117-100**

Antique Iron Knob

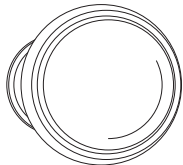

(10a)

**HK119
HK119-100**

Satin Nickel Knob

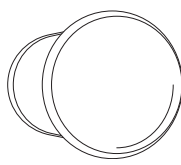

(10a)

**HK120
HK120-100**

Antique Pewter Braided Knob

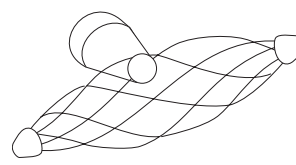

(10a)

**HK123
HK123-100**

Copper-Pewter Knob

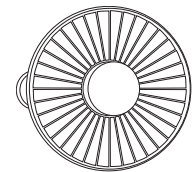

(10a)

**HK125
HK125-100**

Rusty Flower Knob

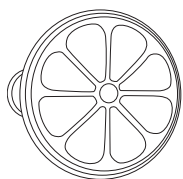

(10a)

**HK126
HK126-100**

Dusty Copper Flower Knob

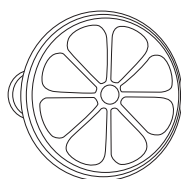

(10a)

**HK127
HK127-100**

Antique Pewter Flower Knob

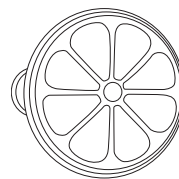

(10a)

**HK128
HK128-100**

Satin Nickel Knob

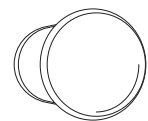

(10a)

**HK137
HK137-100**

Satin Nickel Football Shaped Knob

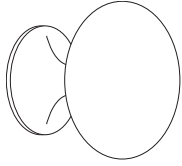

10a

**HK138
HK138-100**

Brushed Satin Pewter French Tassel Round Knob

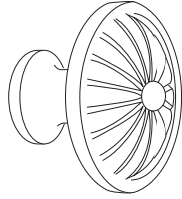

10a

**HK150
HK150-100**

Black Ceramic Insert Round Knob

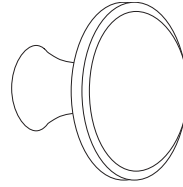

10a

**HK152
HK152-100**

Tumbled Dark Gunmetal Round Knob

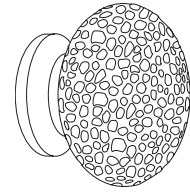

10a

**HK155
HK155-100**

Oil Rubbed Bronze Round Knob

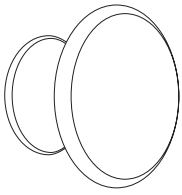

10a

**HK157
HK157-100**

Satin Nickel Diminishing Knob

← 1 17/64" →

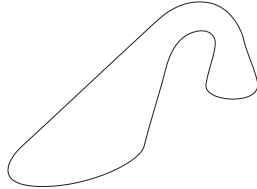

10a

**HK158
HK158-100**

Ochre Finished Ceramic Totem Knob

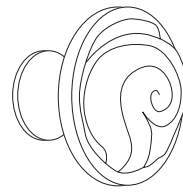

10a

**HK161
HK161-100**

Venetian Bronze Copper French Lace Knob

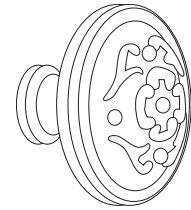

10a

**HK162
HK162-100**

Hardware - Pulls

Construction Options and Modifications

Satin Nickel Suitcase Pull

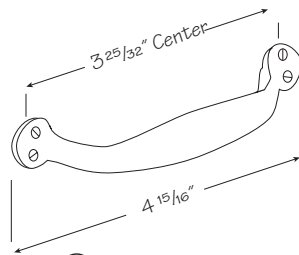

HP103
HP103-100

Satin Nickel Rope Pull

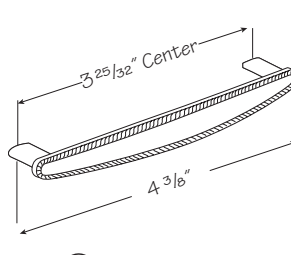

HP106
HP106-100

Satin Aluminum Boat Cleat Transitional Pull

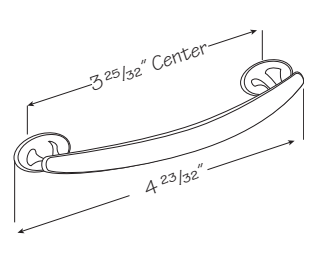

HP112
HP112-100

Satin Nickel Traditional Pull

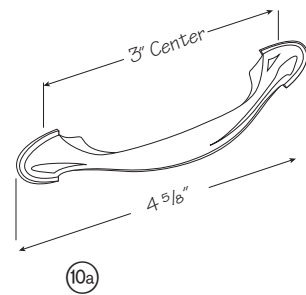

HP118
HP118-100

Antique Pewter Braided Pull

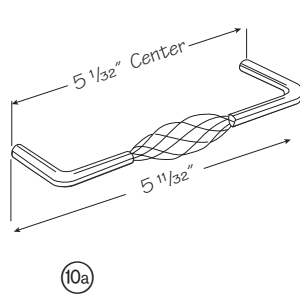

HP124
HP124-100

Satin Nickel Wire Cable Pull

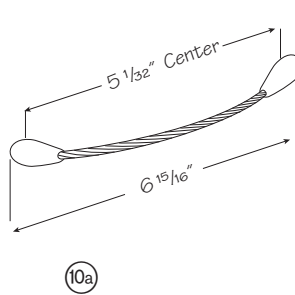

HP131
HP131-100

Satin Nickel Canoe Pull

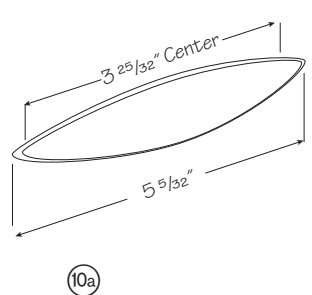

HP135
HP135-100

Satin Nickel Fusilli Pull

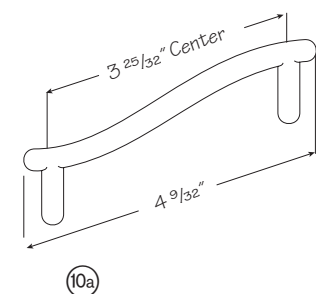

HP139
HP139-100

White Fusilli Pull

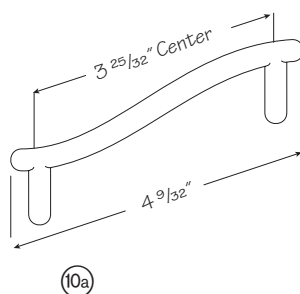

HP140
HP140-100

Brushed Satin Pewter French Tassel Pull

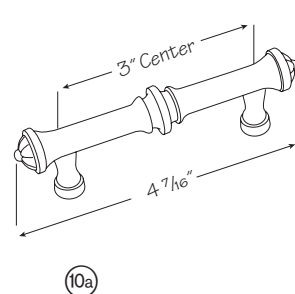

HP151
HP151-100

Black Ceramic Insert Pull

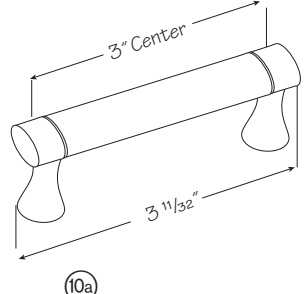

HP153
HP153-100

Tumbled Dark Gunmetal Mission Style Ringed Pendant Pull

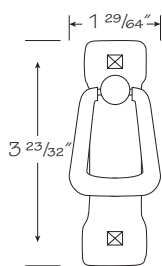

HP154
HP154-100

Oil Rubbed Bronze Cup Pull

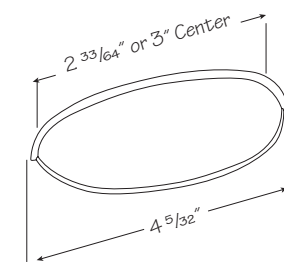

HP156
HP156-100

Satin Nickel Wavy Pull

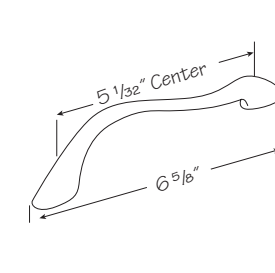

HP159
HP159-100

Ochre Finished Ceramic Totem Pull

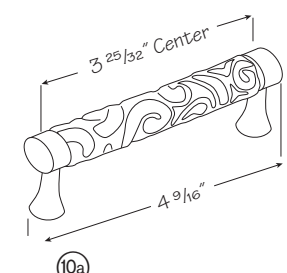

HP160
HP160-100

Chrome Traditional Pull

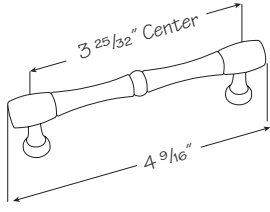

10a

HP163
HP163-100

Satin Nickel Traditional Pull

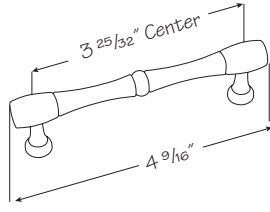

10a

HP164
HP164-100

Bright Brass Traditional Pull

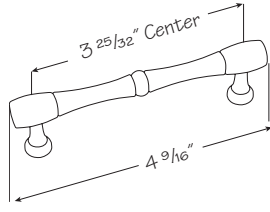

10a

HP165
HP165-100

Black Nickel Traditional Pull

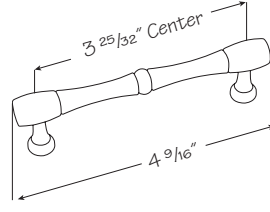

10a

HP166
HP166-100

Hardware

Construction Options and Modifications

(10a)

GDEUMFESAL18

3/4 Extension Side Mount Roller Guide Kit

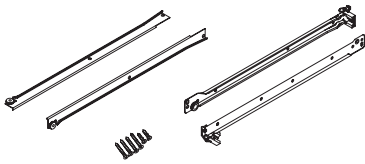

(10a)

GDESM18KIT
GDESM21KIT
GDESM24KIT

- 75 lbs. capacity
- White epoxy coated steel
- Kit includes left and right guides and mounting hardware
- 18 deep used on 18" deep cabinets
- 21 deep used on 21" deep cabinets
- 24 deep used on 24" deep cabinets
- One kit per carton

3/4 Extension Side Mount Roller Guide Peninsula Base Kit

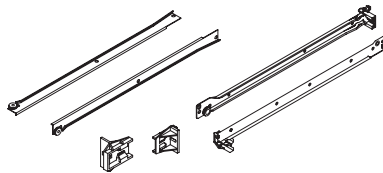

(10a)

GDESMPB24KIT

- 75 lbs. capacity
- White epoxy coated steel
- Kit includes left and right guides and mounting hardware
- Used on Peninsula Base (PB) cabinets
- One kit per carton

3/4 Extension Side Mount Roller Guides

Outer left
guide shown

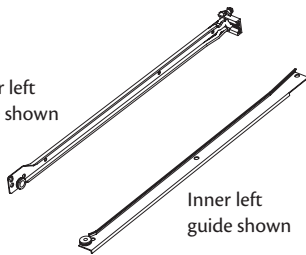

Inner left
guide shown

(10a)

Inner Left
GDESMIL18
GDESMIL21
GDESMIL24

Inner Right
GDESMIR18
GDESMIR21
GDESMIR24

(10a)

Outer Left
GDESMOL18
GDESMOL21
GDESMOL24

Outer Right
GDESMOR18
GDESMOR21
GDESMOR24

- 75 lbs. capacity
- White epoxy coated steel
- 18 deep used on 18" deep cabinets
- 21 deep used on 21" deep cabinets
- 24 deep used on 24" deep cabinets
- One per carton

Full Extension Side Mount Ball Bearing Guide Kit

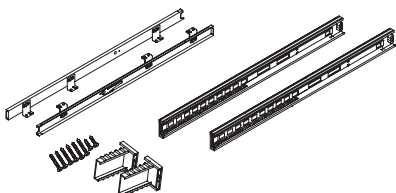

(10a)

24" Deep
GDEFESMBB24KIT

- 75 lbs. capacity
- Full extension guide, pulls out past the face frame
- Kit includes left and right guides and mounting hardware
- One kit per carton

Full Extension Side Mount Ball Bearing Guides

Outer Right guide shown

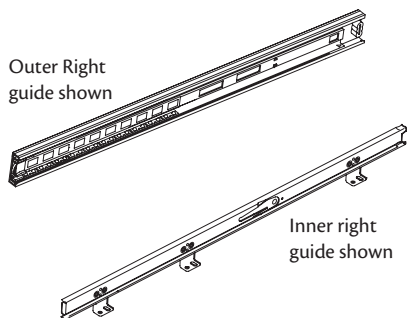

Inner right guide shown

⑩a

GDEFESMBBIL24
GDEFESMBBIR24
GDEFESMBBO24

- 75 lbs. capacity
- Full extension guide, pulls out past the face frame
- One per carton

Full Extension Under Mount SoftAction+ Guide Kit

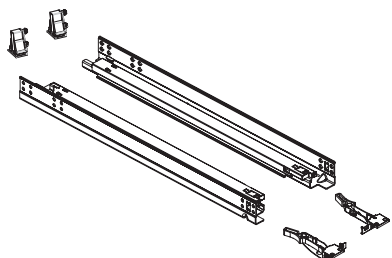

⑩a

GDEUMFESA18KIT
GDEUMFESA21KIT
GDEUMFESA24KIT

- 75 lbs. capacity
- Full extension guide, pulls out past the face frame
- Integrated SoftAction+ closing mechanism
- Kit includes left and right guides and mounting hardware
- Used on cabinets in SDT construction
- 18 deep used on 18" deep cabinets
- 21 deep used on 21" deep cabinets
- 24 deep used on 24" deep cabinets
- One kit per carton

Full Extension Under Mount SoftAction+ Peninsula Base Guide Kit

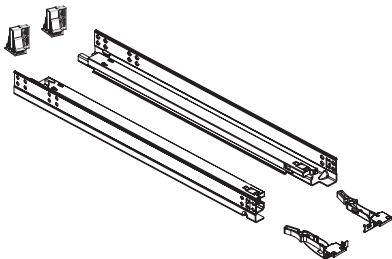

⑩a

GDEUMFESAPB24KIT

- 75 lbs. capacity
- Full extension guide, pulls out past the face frame
- Integrated SoftAction+ closing mechanism
- Used on cabinets in SDT construction
- 24 deep used on 24" deep cabinets
- One kit per carton

Full Extension Under Mount SoftAction+ Guides

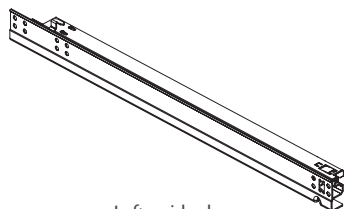

Left guide shown

⑩a

Left
GDEUMFESAL18
GDEUMFESAL21
GDEUMFESAL24

Right
GDEUMFESAR18
GDEUMFESAR21
GDEUMFESAR24

- 75 lbs. capacity
- Full extension guide, pulls out past the face frame
- Integrated SoftAction+ closing mechanism
- Used on cabinets in SDT construction
- 18 deep used on 18" deep cabinets
- 21 deep used on 21" deep cabinets
- 24 deep used on 24" deep cabinets
- One per carton

Locking Device - Full Extension Under Mount SoftAction+ Guides

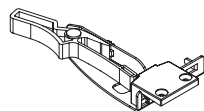

Left shown

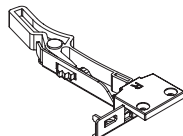

Right shown

⑩a

Left
LKDVUMFESAGDEL
Right
LKDVUMFESAGDER

- LKDVUMFESAGDEL attaches under left front corner of drawer core
- LKDVUMFESAGDER attaches under right front corner of drawer core
- Used on cabinets in SDT construction
- One per carton

Rear Mounting Bracket - 3/4 Extension Side Mount Roller Guides

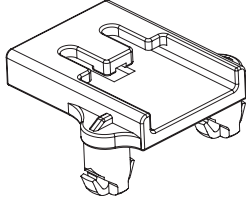

10a
RMBSMGDE

- Attaches using the guide holes in the back of the cabinet
- For use with 3/4 Extension Side Mount Roller Guides
- One per carton

Rear Mounting Bracket - 3/4 Extension Side Mount Roller Guides Peninsula Base

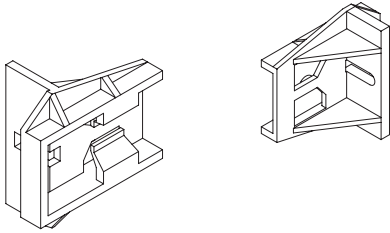

10a
RMBSMGDEPB
RMBSMGDEPB-2

- Attaches to back frame of cabinet using a screw
- For use with Peninsula Base (PB) cabinets with 3/4 Extension Side Mount Roller Guides
- Offered individually or quantities of 2

Rear Mounting Bracket - Full Extension Under Mount SoftAction+ Guides

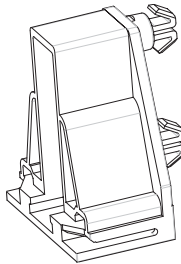

10a
RMBUMFESAGDE-2

- Attaches using the guide holes in the back of the cabinet
- Used on cabinets in SDT construction
- Two per carton

Rear Mounting Bracket - Full Extension Under Mount SoftAction+ Guides Peninsula Base

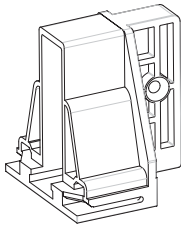

10a
RMBUMFESAGDEPB-2

- Attaches to back frame of cabinet using a screw
- Two per carton

Rear Mounting Bracket - Full Extension Under Mount SoftAction+ Guides DKD

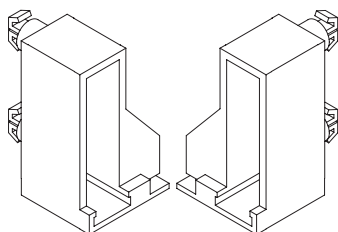

10a
RMBUMFESAGDEDKDSET

- Attaches using the guide holes in the back of the cabinet
- Used on Desk Knee Drawer (DKD) in SDT construction
- Includes a left and right rear mounting bracket
- One set per carton

Rear Mounting Bracket - Full Extension Side Mount Ball Bearing Guides

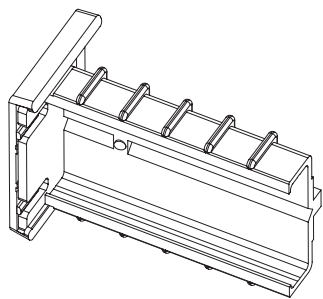

⑩a
RMBFESMBBGDE

- Attaches using the guide holes in the back of the cabinet
- One per carton

170 Degree Hinge

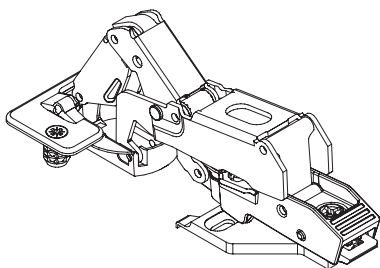

⑩a
HIN170FRM-1CT

- Nickel plated finish
- Includes hinge and mounting plate
- One per carton

Bi-Fold Hinge

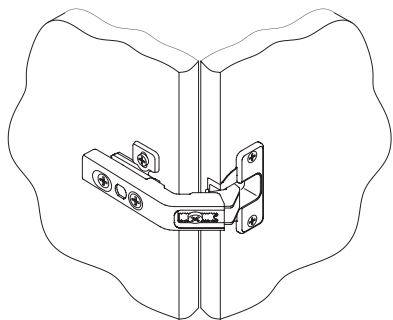

⑩a
HINBIFOLD-1CT

- Nickel plated finish
- Includes hinge and mounting plate
- One per carton

Face Mount Hinge

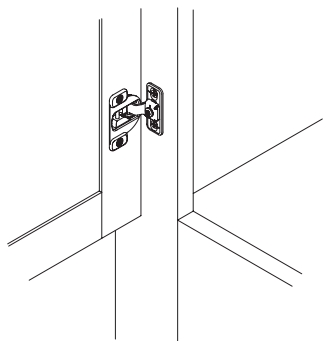

⑩a
HINFM-1PR

- Nickel plated finish
- Used on Traditional and Full Overlay Oven Cabinet Universal (OCU) cabinets
- Used on Traditional and Full Overlay Oven Cabinet Single (OCS) cabinets with painted finishes
- Offered as a pair

Full Overlay 6 Way Hinge

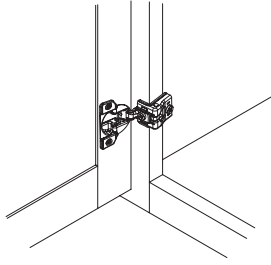

⑩a

HINFOL6WY-1PR

- Nickel plated finish
- 6 way door adjustment
- Includes hinges and mounting screws
- Used on Full Overlay cabinets
- Offered as a pair

Traditional Overlay 6 Way Hinge

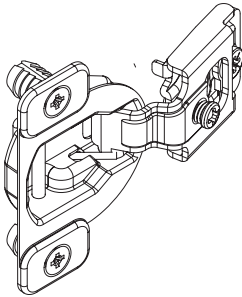

⑩a

HINTOL6WY-1PR

- Nickel plated finish
- 6 way door adjustment
- Includes hinges and mounting screws
- Used on Traditional Overlay cabinets
- Offered as a pair

Medicine Cabinet Pack Hinge

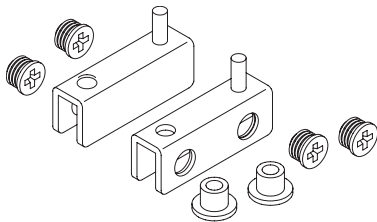

⑩a

HINMCPK

- Nickel plated finish
- Includes upper and lower hinge, bushings and mounting screws
- Used on Medicine Cabinet (MC) and Tri-View Medicine Cabinet (TVMC) cabinets
- Offered as a pair

Utility Tray Hinge

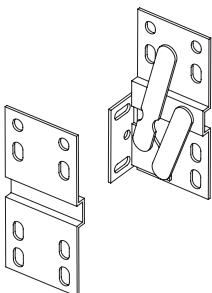

⑩a

HINTOST-1PR

- Nickel plated finish
- Includes left/right hinges and mounting screws
- Used on Sink Base (SB) w/Utility Tray cabinets and Utility Tray Kits (UTK)
- Offered as a pair

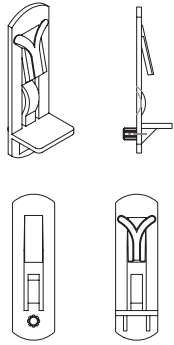

3/4" Shelf Clip

⑩a
SHCLP34

- Clear plastic locking clip
- One per carton

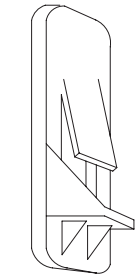

3/4" Shelf Clip with Stop

⑩a
Left
SHCLPLK34L
Right
SHCLPLK34R

- Clear plastic locking clip with front edge restraint
- Used for base cabinets with Half Depth Shelf Option
- One per carton

Left Clip Shown

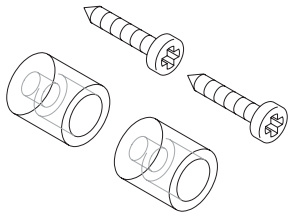

Shelf Support Back Pack

⑩a
SHSUPBP

- Clear plastic shelf support back
- Includes 2 supports and 2 screws per pack
- Used to support the back edge of shelf, attaches to back of cabinet with a screw
- One per carton

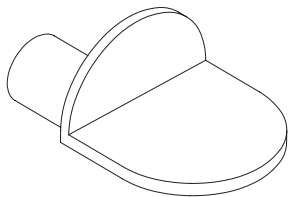

Shelf Support Center

⑩a
SHSUPC

- Clear plastic center shelf support
- Used to support the front edge of shelf, insert into hole in back of center stile
- One per carton

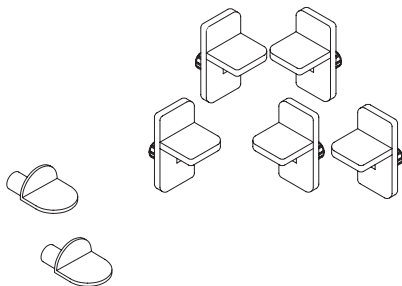

Shelf Support Pack

⑩a
SHSUPPK

- Clear plastic shelf support/center shelf support
- Includes 5 supports and 2 center shelf support
- Used in Bookcase (BK) cabinets
- One per carton

Vent Clip Pack

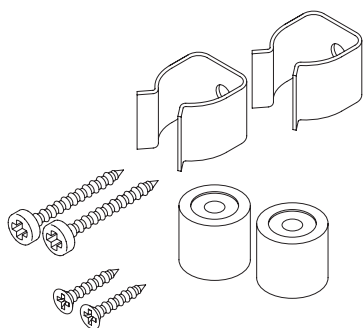

10a
VNTCLPPK

- Used to attach false drawer fronts on Sink Base and select Vanity Cabinets
- Includes two clips, two post and mounting screws per pack
- One per carton

SoftAction Door Hardware

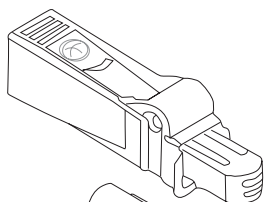

Partial overlay spacer and screws

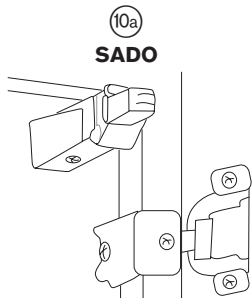
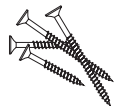

10a
SADO

- Soft-closing technology provides smooth and silent closure of door
- One required per door; U, VLC and UF cabinets require two
- Mounting hardware included
- One per carton
- Note: Requires field installation

Back Plugs



10a
BACKPLUG2H-10
BACKPLUG2H-100

- Clear plastic plugs for base and vanity cabinet back panel factory drilled holes
- Each plug fills a pair of 10mm holes
- Offered individually or quantities of 10 and 100

New

Door Stop Kit

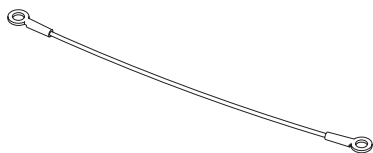

10a
DSTK

Grey color coding indicates new product, size or code.

- Nylon coated stainless wire rope
- Stainless eyes with aluminum collar
- Mounting hardware included

Hardware Template Kit Universal

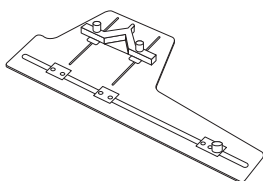

10a
HTK-U

- Handy drill jig for universal hardware drilling
- High-impact grey polycarbonate template with hardened steel drill bushings
- Adjustable for use with all drawers and doors
- One per carton

Touch Up Materials

Construction Options and Modifications



Cabinet Care Kit



- One 8 oz. squeeze bottle of concentrated wood cleaner
- One 8 oz. squeeze bottle of cabinet/furniture polish and restorer
- Two 13" x 12" cleaning and polishing cloths
- One 17" x 13" dusting cloth

Cabinet Cleaning and Polishing Cloths

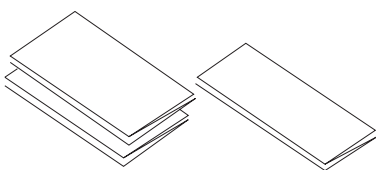

- 13" x 12" cleaning and polishing cloths
- 25 per carton
- Direct ship program

Cabinet Dusting Cloths

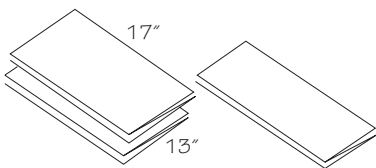

- Treated to pick up and hold dust within cloth
- Six per carton
- Direct ship program

Fill Stick

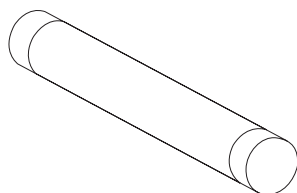

- Matching putty crayon
- Available in all finishes
- One per carton

Touch Up Kit

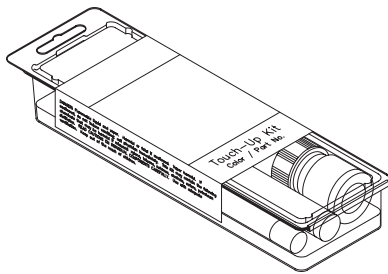

(10a)

TUK

- Available in all finishes
- Used for final touch up and detailing
- Kit includes Touch Up Pen (TP), Fill Stick (FS), a bottle of touch up topcoat and a plastic storage case
- One per carton

Touch Up Pen



(10a)

TP

- Felt tip marker with matching stain or paint
- Available in all finishes
- One per carton

Touch Up Spray Can Primer

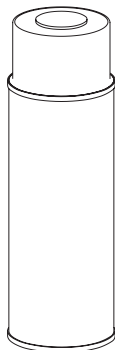

(10a)

TSCP

- Used as part of the process for final touch up of painted finishes only
- For use with Touch Up Spray Can Topcoat (TSCT)
- 13 oz. aerosol spray can
- Direct ship program

Touch Up Spray Can Topcoat

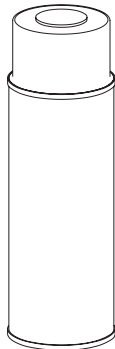

(10a)

TSCT

- Touch up topcoat paint for painted finishes
- For use with Touch Up Spray Can Primer (TSCP)
- 13 oz. aerosol spray can
- Direct ship program

Touch Up Quart

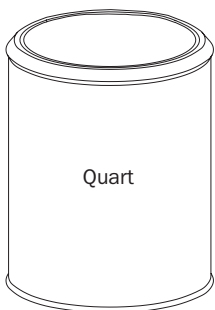

(10a)

Quart Stain

QST

Quart Paint

QP

Quart Glaze

QGL

Quart Clear Sealer/Topcoat

QCST

- Matching stain, paint, glaze and clear sealer/topcoat
- Available in quarts only
- Direct ship program

Stain, Glaze and Paint Direct Ship Information

Items Needed to Reproduce Glaze Finishes

Chiffon with Desert Glaze

- Chiffon Paint
- Medium Brown Glaze
- Clear Sealer/Topcoat

Chiffon with Tuscan Glaze

- Chiffon Paint
- Light Gray Glaze
- Clear Sealer/Topcoat

Cotton with Tuscan Glaze

- Cotton Paint
- Light Gray Glaze
- Clear Sealer/Topcoat

Sable with Ebony Glaze

- Maple Sable Stain
- Charcoal Glaze
- Clear Sealer/Topcoat

Toffee with Java Glaze

- Maple Toffee Stain
- Dark Brown Glaze
- Clear Sealer/Topcoat

Items Needed to Reproduce Accent Glaze Finishes

Chiffon with Desert Accent Glaze

- Chiffon Paint
- Medium Brown Glaze Marker
- Clear Sealer/Topcoat

Chiffon with Tuscan Accent Glaze

- Chiffon Paint
- Light Gray Glaze Marker
- Clear Sealer/Topcoat

Cotton with Tuscan Accent Glaze

- Cotton Paint
- Light Gray Glaze Marker
- Clear Sealer/Topcoat

Sable with Ebony Accent Glaze

- Maple Sable Stain
- Charcoal (black) Glaze Marker
- Clear Sealer/Topcoat

Sedona with Ebony Accent Glaze

- Maple Sedona Stain
- Charcoal (black) Glaze Marker
- Clear Sealer/Topcoat

Toffee with Java Accent Glaze

- Maple Toffee Stain
- Dark Brown Glaze Marker
- Clear Sealer/Topcoat

This listing represents the matching stain, paint and glaze, as well as clear sealer/topcoat needed to reproduce our finishes.

Available in quarts only. The stains are a “two-step” process, requiring first the application of the hand-wipe stain, followed by the application of the clear sealer/topcoat. Instructions and safety data sheets are packaged with each can of stain or clear sealer/topcoat.

Each stain has been developed for a specific wood specie, and is listed within the stain name, i.e., Maple Toffee. If a stain is applied to a wood specie other than it was originally formulated for the color can be expected to have a different appearance.

For optimum in-field color matches, it is recommended that the clear sealer/topcoat be applied following stain application.

There is no warranty on stains or items stained outside our facilities.

Important Note:

The clear sealer/topcoat includes UV inhibitors. Not all sealers/topcoats are clear, and using a formula from another source could alter the appearance and color of the wood.

Items (material) on this page will **not** ship with your cabinet order but will ship directly from our supplier.

Sales Doors

Construction Options and Modifications

10a

SLDO14.75X11.25

Door and Frame Assembly Sales Samples

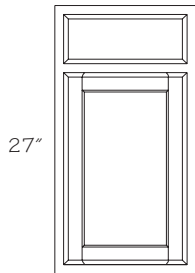

VB12

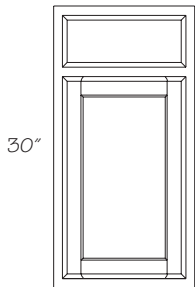

B15

10a

ACCESSDFAVB12
ACCESSDFAB15

- Available in all door styles
- Fits on carousels
- Door and drawer front sizes vary depending on full or partial overlay
- ACCESSDFAVB12 is the face frame/door/drawer front from a VB12 vanity cabinet
- One per carton

Sales Door

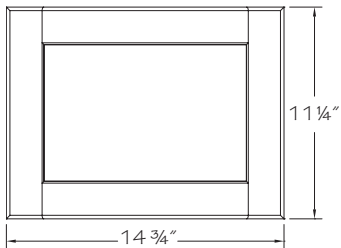

10a

SLDO14.75X11.25

- Available in all door styles, species and finishes
- Includes door only
- One per carton

How to Use This Section

This section lists all replacement doors and drawer fronts by their nomenclature. This section also details the dimensions of each door in the overlays available.

Accessory Non-Drilled Door Information (ANDO)

Accessory non-drilled doors are not prepared for hinges. Accessory non-drilled doors are shipped with pliable bumpers attached.

Accessory non-drilled doors and drawer fronts are coded for easy reference. The prefix indicates door and usage. The first two digits indicate nominal width and the second two digits indicate nominal height.

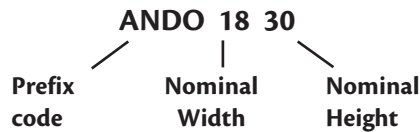

Replacement Door and Drawer Front Information (RDO and RDF)

Replacement doors are prepared for hinges. Replacement doors and drawer fronts are shipped with pliable bumpers attached.

Replacement doors and drawer fronts are coded for easy reference. The prefix indicates door or drawer and usage. For replacement doors the first two digits indicate nominal width and the second two digits indicate nominal height. For replacement drawer fronts the first two digits indicate nominal height and second two digits indicate nominal width.

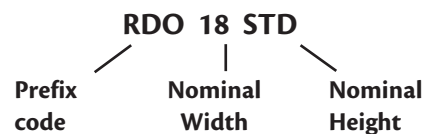
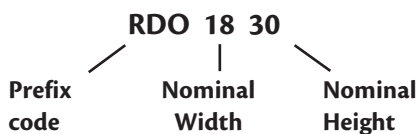

Prefix Codes

ANDO Accessory Non-Drilled Door
RDO Replacement Door

RDF Replacement Drawer Front
PKDC Replacement Packaged Drawer Core

Accessory Non-Drilled Door specific prefix codes are as follows:

ANDOBCR33 Accessory non-drilled door for Base Corner Revolving 33
ANDOBCR36 Accessory non-drilled door for Base Corner Revolving 36
ANDOMTEP1218 Accessory non-drilled door for Matching Tall End Panel 1284 top door
ANDOMTEP12TALL Accessory non-drilled door for Matching Tall End Panel 12 wide tall bottom door
ANDOMTEP21TALL Accessory non-drilled door for Matching Tall End Panel 21 wide tall bottom door
ANDOSBC60-VCD/VSB6035 Accessory non-drilled door for Sink Base Combination 60 - Vanity Combination Drawer/Vanity Sink Base 6035
ANDOBCR36 Accessory non-drilled door for Base Corner Revolving 36
ANDOV60FH Accessory non-drilled door for Vanity Base 60 Full Height
ANDOVCD/VSB60 Accessory non-drilled door for Vanity Combination Drawer/Vanity Sink Base 60
ANDOVSB6035-4D Accessory non-drilled door for Vanity Sink Base Double Bowl 6035 - 4D
ANDOVSB60-3D Accessory non-drilled door for Vanity Sink Base Double Bowl 60 - 3D

Replacement Door specific prefix codes are as follows:

RDOBCR33 Replacement door for Base Corner Revolving 33
RDOBCR36 Replacement door for Base Corner Revolving 36
RDOBLS Replacement door for Base Lazy Susan
RDOVB60FH Replacement door for Vanity Base 60 Full Height
RDOVCD/VSB60 Replacement door for Vanity Combination Drawer/Vanity Sink Base 60
RDOSBC60-VCD/ Replacement door for Sink Base Combination 60 - VSB6035 Vanity Combination Drawer/Vanity Sink Base 6035
RDOVSB6035-4D Replacement door for Vanity Sink Base Double Bowl 6035 - 4D
RDOVSB60-3D Replacement door for Vanity Sink Base Double Bowl 60 - 3D

Replacement Door suffix codes are as follows:

BWBT Base Wastebasket Top Mount
L Left hinged
R Right hinged
BL Butt door left hinged
BR Butt door right hinged
TALLL Tall door left hinged
TALLR Tall door right hinged
TALLB Tall door - butt door

Replacement Drawer Front suffix codes are as follows:

DKD 3.500 or 4.125 front height
STD 5.500 or 6.125 front height
STDUT 5.500 or 6.125 front height with Utility Tray drilling
DP1 9.000 or 9.750 front height
DP2 10.375 or 11.188 front height

PART	Traditional Overlay	Full Overlay
RDO30TALLB	14 1/16 X 60 1/2	14 3/4 X 61 1/8
RDO24TALL	22 1/4 X 60 1/2	23 5/8 X 61 1/8
RDO18TALL	16 1/4 X 60 1/2	17 5/8 X 61 1/8
RDF39STDUT	5 1/2 X 37 1/4	6 1/8 X 38 5/8
RDF36STDUT	5 1/2 X 34 1/4	6 1/8 X 35 5/8
RDF33STDUT	5 1/2 X 31 1/4	6 1/8 X 32 5/8
RDF30STDUT	5 1/2 X 28 1/4	6 1/8 X 29 5/8
RDF27STDUT	5 1/2 X 25 1/4	6 1/8 X 26 5/8
RDF24STDUT	5 1/2 X 22 1/4	6 1/8 X 23 5/8
RDF21STDUT	5 1/2 X 19 1/4	6 1/8 X 20 5/8
RDF45STD	5 1/2 X 20 3/4	6 1/8 X 22 1/8
RDF39STD	5 1/2 X 37 1/4	6 1/8 X 38 5/8
RDF36STD	5 1/2 X 34 1/4	6 1/8 X 35 5/8
RDF33STD	5 1/2 X 31 1/4	6 1/8 X 32 5/8
RDF30STD	5 1/2 X 28 1/4	6 1/8 X 29 5/8
RDF27STD	5 1/2 X 25 1/4	6 1/8 X 26 5/8
RDF24STD	5 1/2 X 22 1/4	6 1/8 X 23 5/8
RDF21STD	5 1/2 X 19 1/4	6 1/8 X 20 5/8
RDF18STD	5 1/2 X 16 1/4	6 1/8 X 17 5/8
RDF15STD	5 1/2 X 13 1/4	6 1/8 X 14 5/8
RDF12STD	5 1/2 X 10 1/4	6 1/8 X 11 5/8
RDOVB60FH	12 5/8 X 25	14 X 26 1/4
RDF36DP2	10 3/8 X 34 1/4	11 3/16 X 35 5/8
RDF33DP2	10 3/8 X 31 1/4	11 3/16 X 32 5/8
RDF30DP2	10 3/8 X 28 1/4	11 3/16 X 29 5/8
RDF27DP2	10 3/8 X 25 1/4	11 3/16 X 26 5/8
RDF24DP2	10 3/8 X 22 1/4	11 3/16 X 23 5/8
RDF21DP2	10 3/8 X 19 1/4	11 3/16 X 20 5/8
RDF18DP2	10 3/8 X 16 1/4	11 3/16 X 17 5/8
RDF15DP2	10 3/8 X 13 1/4	11 3/16 X 14 5/8
RDF12DP2	10 3/8 X 10 1/4	11 3/16 X 11 5/8
RDF24DP1	9 X 22 1/4	9 3/4 X 23 5/8
RDF21DP1	9 X 19 1/4	9 3/4 X 20 5/8
RDF18DP1	9 X 16 1/4	9 3/4 X 17 5/8
RDF15DP1	9 X 13 1/4	9 3/4 X 14 5/8
RDF12DP1	9 X 10 1/4	9 3/4 X 11 5/8
RDF36DKD	3 1/2 X 34 1/4	4 1/8 X 35 5/8
RDF30DKD	3 1/2 X 28 1/4	4 1/8 X 29 5/8
RDOVSB6035-4D	18 5/8 X 21 1/2	20 X 22 3/4
RDO3642B	17 1/16 X 40	17 3/4 X 41 1/4
RDO3342B	15 9/16 X 40	16 1/4 X 41 1/4
RDO3042B	14 1/16 X 40	14 3/4 X 41 1/4
RDO2742B	12 9/16 X 40	13 1/4 X 41 1/4
RDO2442B	11 1/16 X 40	11 3/4 X 41 1/4
RDO942	7 1/4 X 40	8 5/8 X 41 1/4
RDO3942	17 3/4 X 40	19 1/8 X 41 1/4
RDO3342	14 3/4 X 40	16 1/8 X 41 1/4
RDO2442	22 1/4 X 40	23 5/8 X 41 1/4
RDO2142	19 1/4 X 40	20 5/8 X 41 1/4
RDO1842	16 1/4 X 40	17 5/8 X 41 1/4
RDO1542	13 1/4 X 40	14 5/8 X 41 1/4
RDO1242	10 1/4 X 40	11 5/8 X 41 1/4
RDFVSB60-3DSTD	5 1/2 X 18 5/8	6 1/8 X 20
RDOVSB60-3D	18 5/8 X 18 1/2	20 X 19 3/4
RDO3636B	17 1/16 X 34	17 3/4 X 35 1/4
RDO3336B	15 9/16 X 34	16 1/4 X 35 1/4
RDO3036B	14 1/16 X 34	14 3/4 X 35 1/4
RDO2736B	12 9/16 X 34	13 1/4 X 35 1/4

PART	Traditional Overlay	Full Overlay
RDO2436B	11 1/16 X 34	11 3/4 X 35 1/4
RDO936	7 1/4 X 34	8 5/8 X 35 1/4
RDO3936	17 3/4 X 34	19 1/8 X 35 1/4
RDO3336	14 3/4 X 34	16 1/8 X 35 1/4
RDO2136	19 1/4 X 34	20 5/8 X 35 1/4
RDO1836	16 1/4 X 34	17 5/8 X 35 1/4
RDO1536	13 1/4 X 34	14 5/8 X 35 1/4
RDO1236	10 1/4 X 34	11 5/8 X 35 1/4
RDO3630B	17 1/16 X 28	17 3/4 X 29 1/4
RDO3330B	15 9/16 X 28	16 1/4 X 29 1/4
RDO3030B	14 1/16 X 28	14 3/4 X 29 1/4
RDO2730B	12 9/16 X 28	13 1/4 X 29 1/4
RDO2430B	11 1/16 X 28	11 3/4 X 29 1/4
RDO930	7 1/4 X 28	8 5/8 X 29 1/4
RDO4530	20 3/4 X 28	22 1/8 X 29 1/4
RDO3930	17 3/4 X 28	19 1/8 X 29 1/4
RDO3330	14 3/4 X 28	16 1/8 X 29 1/4
RDO2430	22 1/4 X 28	23 5/8 X 29 1/4
RDO2130	19 1/4 X 28	20 5/8 X 29 1/4
RDO1830	16 1/4 X 28	17 5/8 X 29 1/4
RDO1530	13 1/4 X 28	14 5/8 X 29 1/4
RDO1230	10 1/4 X 28	11 5/8 X 29 1/4
RDFVCD/VSB60-2DSTD	5 1/2 X 27	6 1/8 X 28 3/8
RDO3627B	17 1/16 X 25	17 3/4 X 26 1/4
RDO3027B	14 1/16 X 25	14 3/4 X 26 1/4
RDO2427	22 1/4 X 25	23 5/8 X 26 1/4
RDO2127	19 1/4 X 25	20 5/8 X 26 1/4
RDO1827	16 1/4 X 25	17 5/8 X 26 1/4
RDO1527	13 1/4 X 25	14 5/8 X 26 1/4
RDO1824BWB	16 1/4 X 21 1/2	17 5/8 X 22 3/4
RDO1524BWB	13 1/4 X 21 1/2	14 5/8 X 22 3/4
RDO3624B	17 1/16 X 21 1/2	17 3/4 X 22 3/4
RDO3324B	15 9/16 X 21 1/2	16 1/4 X 22 3/4
RDO3024B	14 1/16 X 21 1/2	14 3/4 X 22 3/4
RDO2724B	12 9/16 X 21 1/2	13 1/4 X 22 3/4
RDO2424B	11 1/16 X 21 1/2	11 3/4 X 22 3/4
RDO4524	20 3/4 X 21 1/2	22 1/8 X 22 3/4
RDO3924	17 3/4 X 21 1/2	19 1/8 X 22 3/4
RDO3324	14 3/4 X 21 1/2	16 1/8 X 22 3/4
RDO2724	11 3/4 X 21 1/2	13 1/8 X 22 3/4
RDO2424	22 1/4 X 21 1/2	23 5/8 X 22 3/4
RDO2124	19 1/4 X 21 1/2	20 5/8 X 22 3/4
RDO1824	16 1/4 X 21 1/2	17 5/8 X 22 3/4
RDO1524	13 1/4 X 21 1/2	14 5/8 X 22 3/4
RDO1224	10 1/4 X 21 1/2	11 5/8 X 22 3/4
RDO3621B	17 1/16 X 18 1/2	17 3/4 X 19 3/4
RDO3021B	14 1/16 X 18 1/2	14 3/4 X 19 3/4
RDO2121	19 1/4 X 18 1/2	20 5/8 X 19 3/4
RDO1821	16 1/4 X 18 1/2	17 5/8 X 19 3/4
RDO1521	13 1/4 X 18 1/2	14 5/8 X 19 3/4
RDO1221	10 1/4 X 18 1/2	11 5/8 X 19 3/4
RDO3618B	17 1/16 X 16	17 3/4 X 17 1/4
RDO3318B	15 9/16 X 16	16 1/4 X 17 1/4
RDO3018B	14 1/16 X 16	14 3/4 X 17 1/4
RDO3918	17 3/4 X 16	19 1/8 X 17 1/4
RDO2418	22 1/4 X 16	23 5/8 X 17 1/4
RDO1818	16 1/4 X 16	17 5/8 X 17 1/4
RDO3615B	17 1/16 X 13	17 3/4 X 14 1/4

PART	Traditional Overlay	Full Overlay
RDO3315B	15 9/16 X 13	16 1/4 X 14 1/4
RDO3015B	14 1/16 X 13	14 3/4 X 14 1/4
RDO3612B	17 1/16 X 10	17 3/4 X 11 1/4
RDO3012B	14 1/16 X 10	14 3/4 X 11 1/4
RDO3912	17 3/4 X 10	19 1/8 X 11 1/4
RDO1812	16 1/4 X 10	17 5/8 X 11 1/4
RDOVCD/VSB60	12 5/8 X 18 1/2	14 X 19 3/4
RDOSBC60-VCD/VSB6035	12 5/8 X 21 1/2	14 X 22 3/4
RDOBLS	10 1/8 X 27 1/4	N/A
RDOBCR36	10 1/4 X 28	10 15/16 X 29 1/4
RDOBCR33	7 1/4 X 28	7 15/16 X 29 1/4
RDFBBC45/48STD	5 1/2 X 17 3/4	6 1/8 X 19 1/8
RDF33/2STD	5 1/2 X 14 3/4	6 1/8 X 16 1/8
RDF27/2STD	5 1/2 X 11 3/4	6 1/8 X 13 1/8

PART	Traditional Overlay	Full Overlay
ANDO1221	10 1/4 X 18 1/2	11 5/8 X 19 3/4
ANDO1224	10 1/4 X 21 1/2	11 5/8 X 22 3/4
ANDO1230	10 1/4 X 28	11 5/8 X 29 1/4
ANDO1236	10 1/4 X 34	11 5/8 X 35 1/4
ANDO1242	10 1/4 X 40	11 5/8 X 41 1/4
ANDO1521	13 1/4 X 18 1/2	14 5/8 X 19 3/4
ANDO1524	13 1/4 X 21 1/2	14 5/8 X 22 3/4
ANDO1527	13 1/4 X 25	14 5/8 X 26 1/4
ANDO1530	13 1/4 X 28	14 5/8 X 29 1/4
ANDO1536	13 1/4 X 34	14 5/8 X 35 1/4
ANDO1542	13 1/4 X 40	14 5/8 X 41 1/4
ANDO1812	16 1/4 X 10	17 5/8 X 11 1/4
ANDO1818	16 1/4 X 16	17 5/8 X 17 1/4
ANDO1821	16 1/4 X 18 1/2	17 5/8 X 19 3/4
ANDO1824	16 1/4 X 21 1/2	17 5/8 X 22 3/4
ANDO1827	16 1/4 X 25	17 5/8 X 26 1/4
ANDO1830	16 1/4 X 28	17 5/8 X 29 1/4
ANDO1836	16 1/4 X 34	17 5/8 X 35 1/4
ANDO1842	16 1/4 X 40	17 5/8 X 41 1/4
ANDO18TALL	16 1/4 X 60 1/2	17 5/8 X 61 1/8
ANDO2118	19 1/4 X 16	20 5/8 X 17 1/4
ANDO2121	19 1/4 X 18 1/2	20 5/8 X 19 3/4
ANDO2124	19 1/4 X 21 1/2	20 5/8 X 22 3/4
ANDO2127	19 1/4 X 25	20 5/8 X 26 1/4
ANDO2130	19 1/4 X 28	20 5/8 X 29 1/4
ANDO2136	19 1/4 X 34	20 5/8 X 35 1/4
ANDO2142	19 1/4 X 40	20 5/8 X 41 1/4
ANDO2418	22 1/4 X 16	23 5/8 X 17 1/4
ANDO2424B	11 1/16 X 21 1/2	11 3/4 X 22 3/4
ANDO2424	22 1/4 X 21 1/2	23 5/8 X 22 3/4
ANDO2427	22 1/4 X 25	23 5/8 X 26 1/4
ANDO2430B	11 1/16 X 28	11 3/4 X 29 1/4
ANDO2430	22 1/4 X 28	23 5/8 X 29 1/4
ANDO2436B	11 1/16 X 34	11 3/4 X 35 1/4
ANDO2436	22 1/4 X 34	23 5/8 X 35 1/4
ANDO2442B	11 1/16 X 40	11 3/4 X 41 1/4
ANDO2442	22 1/4 X 40	23 5/8 X 41 1/4
ANDO24TALL	22 1/4 X 60 1/2	23 5/8 X 61 1/8
ANDO2724	11 3/4 X 21 1/2	13 1/8 X 22 3/4
ANDO2724B	12 9/16 X 21 1/2	13 1/4 X 22 3/4
ANDO2730B	12 9/16 X 28	13 1/4 X 29 1/4
ANDO2736B	12 9/16 X 34	13 1/4 X 35 1/4
ANDO2742B	12 9/16 X 40	13 1/4 X 41 1/4
ANDO3012B	14 1/16 X 10	14 3/4 X 11 1/4
ANDO3015B	14 1/16 X 13	14 3/4 X 14 1/4
ANDO3018B	14 1/16 X 16	14 3/4 X 17 1/4
ANDO3021B	14 1/16 X 18 1/2	14 3/4 X 19 3/4
ANDO3024B	14 1/16 X 21 1/2	14 3/4 X 22 3/4
ANDO3027B	14 1/16 X 25	14 3/4 X 26 1/4
ANDO3030B	14 1/16 X 28	14 3/4 X 29 1/4
ANDO3036B	14 1/16 X 34	14 3/4 X 35 1/4
ANDO3042B	14 1/16 X 40	14 3/4 X 41 1/4
ANDO30TALLB	14 1/16 X 60 1/2	14 3/4 X 61 1/8
ANDO3315B	15 9/16 X 13	16 1/4 X 14 1/4
ANDO3318B	15 9/16 X 16	16 1/4 X 17 1/4
ANDO3324	14 3/4 X 21 1/2	16 1/8 X 22 3/4
ANDO3324B	15 9/16 X 21 1/2	16 1/4 X 22 3/4
ANDO3330B	15 9/16 X 28	16 1/4 X 29 1/4

PART	Traditional Overlay	Full Overlay
ANDO3330	14 3/4 X 28	16 1/8 X 29 1/4
ANDO3336B	15 9/16 X 34	16 1/4 X 35 1/4
ANDO3336	14 3/4 X 34	16 1/8 X 35 1/4
ANDO3342B	15 9/16 X 40	16 1/4 X 41 1/4
ANDO3342	14 3/4 X 40	16 1/8 X 41 1/4
ANDO3612B	17 1/16 X 10	17 3/4 X 11 1/4
ANDO3615B	17 1/16 X 13	17 3/4 X 14 1/4
ANDO3618B	17 1/16 X 16	17 3/4 X 17 1/4
ANDO3621B	17 1/16 X 18 1/2	17 3/4 X 19 3/4
ANDO3624B	17 1/16 X 21 1/2	17 3/4 X 22 3/4
ANDO3627B	17 1/16 X 25	17 3/4 X 26 1/4
ANDO3630B	17 1/16 X 28	17 3/4 X 29 1/4
ANDO3636B	17 1/16 X 34	17 3/4 X 35 1/4
ANDO3642B	17 1/16 X 40	17 3/4 X 41 1/4
ANDO3912	17 3/4 X 10	19 1/8 X 11 1/4
ANDO3918	17 3/4 X 16	19 1/8 X 17 1/4
ANDO3924	17 3/4 X 21 1/2	19 1/8 X 22 3/4
ANDO3930	17 3/4 X 28	19 1/8 X 29 1/4
ANDO3936	17 3/4 X 34	19 1/8 X 35 1/4
ANDO3942	17 3/4 X 40	19 1/8 X 41 1/4
ANDO4524	20 3/4 X 21 1/2	22 1/8 X 22 3/4
ANDO4530	20 3/4 X 28	22 1/8 X 29 1/4
ANDO930	7 1/4 X 28	8 5/8 X 29 1/4
ANDO936	7 1/4 X 34	8 5/8 X 35 1/4
ANDO942	7 1/4 X 40	8 5/8 X 41 1/4
ANDOB3CR33	7 1/4 X 28	7 15/16 X 29 1/4
ANDOB3CR36	10 1/4 X 28	10 15/16 X 29 1/4
ANDOMTEP1218	10 1/4 X 16	11 3/4 X 17 1/4
ANDOMTEP12TALL	10 1/4 X 60 1/2	11 3/4 X 61 1/8
ANDOMTEP21TALL	19 1/4 X 60 1/2	20 5/8 X 61 1/8
ANDOSBC60-VCD/VSB6035	12 5/8 X 21 1/2	14 X 22 3/4
ANDOVCD/VSB60	12 5/8 X 18 1/2	14 X 19 3/4
ANDOVSB60-3D	18 5/8 X 18 1/2	20 X 19 3/4
ANDOVSB6035-4D	18 5/8 X 21 1/2	20 X 22 3/4



We are America's Cabinetmaker.®

Express™ Product Line

Merillat® Cabinets

Merillat® cabinetry makes better use of nature's hardwood, while providing a quality product. The wide range of wood colors and grain variations are natural characteristics of the wood and not a defect.

CABINET FRAMES

3/4" thick, kiln dried, solid hardwood joined with pocket screw joinery construction.

END PANELS

3/8" thick engineered wood is permanently finished on 2 sides with a laminate resistant to water and most household chemicals. End panels are machined to accept tops, bottoms, backs, and corner gussets. Ends are drilled to accept adjustable shelves. Tall cabinet end panels are 1/2" thick.

WALL TOPS & BOTTOMS

1/2" thick engineered wood is permanently finished on 2 sides with a laminate resistant to water and most household chemicals.

BASE BOTTOMS

1/2" thick engineered wood is permanently finished on 1 side with a laminate resistant to water and most household chemicals.

SHELVES

3/4" thick engineered wood is permanently finished on 2 sides for full depth shelves and 1 side for half-depth Base cabinet shelving with a laminate resistant to water and most household chemicals. Front edge is edge banded with melamine banding. Wall and Base cabinets have adjustable shelves supported by adjustable shelf clips.

Half-depth shelves in Base cabinets 39" wide and wider have a matching full-length support apron secured to the underside near the front edge for additional support. Shelves are designed to support 15 lbs. per square foot, not to exceed 50 lbs. per shelf.

BOOKCASE SHELVES

3/4" thick engineered wood, permanently laminated two sides to match exterior finish of cabinet. All bookcase units have adjustable shelves. Front edge is edge banded.

WALL BACKS

3/8" thick engineered wood finished on one side with a laminate resistant to water and household chemicals. Full-length dados in back allow tops and bottoms to be captured, stapled and glued.

BASE BACKS

1/4" thick engineered wood finished on one side with a laminate resistant to water and household chemicals. Extends full-length to floor.

WALL HANGRAILS

3/8" thick engineered wood full-length across top and bottom secured with staples.

BASE HANGRAILS

11/16" solid pine or Douglas-fir. Ends are rabbeted to join cabinet ends. Bottom edge is rabbeted to join back.

DRAWER GUIDES

75 pound rated drawer guide system, side mounted, 3/4 extension with self adjusting mounting brackets at rear. Drawer slides are fastened to the drawer box with screws.

DRAWER FRONTS

3/4" solid hardwood on all wood styles. Laminate and substrate on laminate drawer fronts use the same materials as corresponding door style.

DRAWER BOX

1/2" thick sides, fronts and backs of engineered wood. Top edges are finished with melamine banding. Side surfaces are finished with a laminate resistant to water and most household chemicals. 1/4" thick engineered wood bottom panel is finished on one side with same laminate. Laminate/edgebanding finish is Natural Maple. Drawer sides are rabbeted to join the drawer box fronts and backs. Each corner is joined with glue and stapled.

Drawers 30" and wider have 3/8" thick bottoms. Standard drawer interior height is 3 5/8"; deep drawers are 6 7/8". Base cabinet interior front-to-back depth is 20 11/16", Vanity is 17 15/16", and Vanity Space Saver is 14 11/16".

OPTIONAL DOVETAIL WOOD DRAWER WITH UNDERMOUNT GUIDE SYSTEM

5/8" sides, fronts and backs are solid hardwood. Drawer sides, fronts and backs are joined with half blind dovetail joints.

Nominal 3/16" plywood drawer bottom has laminate surface for easy cleaning. Drawer bottom is joined to the drawer sides, front and back on all 4 sides with a groove.

Hardwood drawer components are finished with clear sealer and topcoat on exposed surfaces. Standard drawer interior height is 2 3/4"; deep drawers are 5 3/4". Base cabinet interior front-to-back depth is 19 13/32", Vanity is 16 7/16" and Vanity Space Saver is 13 1/2".

Full extension soft close undermount guide system is concealed, self closing and can be adjusted to align the drawer head.

TOEKICK

1/2" thick engineered wood. Toekick extends from floor to bottom of cabinet, closing the toe kick area. Toekick Cover is required and sold separately.

HINGES

Traditional overlay door styles come with fully concealed European style hinges that feature 105° opening, 6-way adjustment, and a self closing feature on most doors.

Full overlay door styles come with fully concealed European style hinges that feature 107° opening, 6-way adjustment, and a self closing feature on most doors.

Some corner cabinets using concealed hinges will have hinges with wider opening capability for improved access.

Fire Resistance

Overlaid engineered wood used for cabinet construction has been tested in accordance with UL standard recognized-ASTM E 162-90-Standard Test Method for Surface Flammability of Materials, using a radiant heat energy source, and HUD Standard 3280.203, .204 and .209.

Formaldehyde Emissions Levels

Formaldehyde emissions comply with requirements of 24 CFR, Part 3280 (August 9, 1984), the HUD rule on Manufactured Home Construction and Safety Standards and 29 CFR Part 1910 (May 27, 1992), the OSHA rule on Occupational Exposure to Formaldehyde. Formaldehyde emissions for raw engineered wood is restricted to 0.3 parts per million.

CERTIFIED CABINET AND FACILITY

Merillat® cabinetry carries the seal of the Kitchen Cabinet Manufacturers Association (KCMA) Certification Program, which assures that our cabinets meet or exceed the rigorous standards set by the American National Standards Institute (ANSI). Our cabinets are also independently tested to ANSI/KCMA A161.1-2000 and paragraph 611-1.1, "HUD Minimum Property Standards-Housing 4910.1" 9-8-86.

In keeping with our policy of continuous refinement, Masco Cabinetry LLC reserves the right to alter specifications and styles without general notice or obligation to make similar changes in products previously manufactured.

Merillat® demonstrates its commitment to environmental sustainability through meeting or exceeding the requirements as outlined in the Environmental Stewardship Program certification, administered by the KCMA.

All Merillat® facilities have also obtained ISO 14001 certificate of approval, demonstrating our commitment to reducing the impact of operations on the environment.

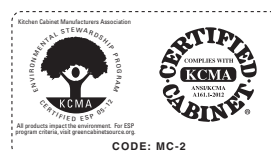

Use and Care

Wood

The fine “furniture” finish of your cabinets is designed for daily usage. All wood and laminate surfaces may be cleaned with a damp, soft cloth moistened with pure soap suds (**not** detergent), then wiped dry with another soft cloth. As with all cabinet surfaces, take a little extra care on bottom edges of cabinets and cabinet doors where invisible moisture often collects.

Note: DO NOT use detergents, soap pads, steel wool, or other harsh, abrasive material on your cabinetry.

Polishing Wood

Remove dust from cabinets frequently with a soft lint-free cloth. The cloth may be slightly dampened with water or a spray type dust remover.

Clean spills immediately. Use a clean cloth and mild soap if necessary. Wipe dry with a clean soft cloth.

We recommend that you wash and polish cabinets once or twice a year. Use a light coat of quality furniture polish. Don't use a paste wax; the wax build up is difficult to remove and will leave a residue that attracts dust and moisture. Polishes that contain silicone should **not** be used.

Laminate Door Surfaces

Periodically clean the interior and exterior surfaces of the door using a soft, dampened cloth. Tough stains may be cleaned using a soft cloth dampened with a “409” or “Simple Green” type cleanser.

Wire Storage Products

Periodically clean with soft damp cloth. **Note:** Do **not** use detergents, soap pads, steel wool, or other harsh, abrasive material.

Roller Slide Systems

Periodically clean with a soft damp cloth. Ball bearing slides are lubricated with grease from the manufacturer to ensure smooth quiet operation and long life. Avoid removal of this grease during cleaning.

Preventative Care: Self-Cleaning Ovens

Self-cleaning ovens are cleaned through the use of intense heat. If the heat gasket does **not** seal properly, heat may escape from the oven. Cabinet components installed near the oven may suffer finish or surface damage. To minimize the risk of damage during cleaning cycles, we recommend that you open doors and drawers from cabinets that are above and adjacent to a self-cleaning oven.

Preventative Care: Heat-Producing Appliances

We recommend that you do **not** mount heat-producing appliances (such as coffee makers and toaster ovens) beneath cabinets. Excess heat and moisture from these appliances can damage cabinets.

The Beauty Of Natural Wood

The natural hardwoods we use in our product have characteristics that make every cabinet both beautiful and unique. All hardwoods have their own personality, and variation in color, texture, and grain pattern are an inherent part of this natural material.

Natural hardwood variations often include distinctive grain patterns or unusual shadings in color. These reflect the “life history” of the tree and contribute to the unique look of your cabinets.

As with other natural materials, your hardwood cabinets will be affected by environmental factors such as natural and artificial lighting, so you can expect to see the color gradually change and mellow over time.

Your satisfaction is important to us, and we want you to feel as good about buying our cabinets as we do about making them. Be assured only the best materials go into our natural hardwood cabinetry, including those hardwoods that may be considered unique. Because, at Masco Cabinetry LLC, we believe natural distinctive hardwoods are beautiful.

Due to the unique qualities inherent in the natural hardwoods used in this cabinetry, neither Masco Cabinetry LLC, nor your dealer, can be responsible for the actual degree of variation that may characterize your cabinetry purchase.

Warping, Cracking & Proper Humidity

As a natural characteristic, all wood products contain moisture. Changes in temperature and humidity affect the moisture content in wood, which causes wood to expand or contract. Over time, this expansion or contraction can cause warping and joint cracks to occur, potentially causing permanent deformations, in wood cabinetry.

To help prevent excessive movement in your wood cabinetry, we recommend maintaining a controlled environment of 70 degrees to 75 degrees Fahrenheit and 30% to 50% humidity in the areas where your cabinetry is stored or installed. Environmental conditions cannot be controlled by Masco Cabinetry and the effects of movement in wood is not considered to be a manufacturing defect and will not be considered as a reason for replacement.

CODE	PAGE	CODE	PAGE	CODE	PAGE	CODE	PAGE	CODE	PAGE
1		D		M		SHO	J5	WL	D8
1FT	C6	DEP	H2	MBEP	E15	SHSUPBPK	K6	WMS	D9
1ST	C5	DKD	H1	MC	G6	SHSUPC	K6	WR	D2
2		DSTK	K7	MRS	A3	SHSUPPK	K6	WSM	J5
2FT	C6			MTEP	F6	SLDO	K11		
2ST	C5	F		MVEP	G9	SM	J5		
		FS	K8	MWEP	D11	SN5	A6		
						SV5	A7		
4				N		SWS	J5		
4ST	C5	G		NBM	J4				
		GDEFESMBB	K1			T			
		GDEFESMBBIL	K2			TEP	F6		
A		GDEFESMBBIR	K2	O		TEPF	F6		
AB5	A2	GDEFESMBBO	K2	OCS	F4	TF	F5		
ACCESSDFAB	K11	GDESM	K1	OCS	F4	TFB	J4		
ACCESSDFAVB	K11	GDESMIL	K1	OCSP	F4	TKCL	E13, F5, G9		
ACM	J2	GDESMIR	K1	OCU	F3	TKCV	E13, F5, G9		
		GDESMOL	K1	ODK	F4	TP	K9		
B		GDESMOR	K1	OSC	J2	TSCP	K9		
B	E1, E2	GDESMPB	K1			TSCT	K9		
BACKPLUG2H	K7	GDEUMFESA	K2	P		TUK	K9		
BBC	E9	GDEUMFESAL	K2	PB	E2, E3, I1	TVMC	G7		
BCFS	E11	GDEUMFESAPB	K2	PBBC	E9				
BCR	E10	GDEUMFESAR	K2	PR5	A4				
BD	E3			PW	D2, D3	U			
BEP	E15			PWA	D6	U	F1, F2		
BEPF	E14	H				UCM	J6		
BF	E14	HDS	C5	Q		USK	I2		
BFC	E14	HIN170FRM	K4	QCST	K9	UTK	E13		
BK	D8	HINBIFOLD	K4	QGL	K9				
BLS	E10	HINFEM	K4	QP	K9	V			
BTK	I3	HINFOL4WY	K4	QR	J4	V	J1		
BWBFMK	E12	HINFOL6WY	K5	QST	K9	VB	G1, G2		
BWBT	E3	HINMCPK	K5			VCD	G4, G5		
BWBTK	E12	HINTOL2WY	K5	R		VD	G5		
		HINTOL6WY	K5	RA5	A5	VF	G8		
		HINTOST	K5	RMBFESMBBGDE	K4	VLC	G6		
C		HK	J7, J8	RMBSMGDE	K3	VLSK	I2		
CCK	K8	HP	J9, J10	RMBSMGDEPB	K3	VNTCLPPK	K7		
CCM	J3	HTK-U	K7	RMBUMFESAGDE	K3	VSB	G2, G3, G4		
CCM-SW	J3			RMBUMFESAGDEDKDSET	K3	VTK	I4		
CCPC	K8	I		RMBUMFESAGDEPB	K3	VTKS	I4		
CDC	K8	ICM	J2	ROT	I5	VW	G6		
CDI	E13					VWB	G6		
CFO	C6	K		S		VW	G9		
CGPB	I1	KSCCK	E26	SADO	K7	VWB	G8, G9		
CM	J3			SB	E4, E5, E6				
CM-SW	J3	L		SBA	E7	W			
CSO	C6	LKDVUMFESAGDEL	K2	SBT	J5	W	D1, D2		
CTD	J2	LKDVUMFESAGDER	K2	SCM	J4	WA	D6		
CTSB	J1	LS	D10	SF	E7	WBC	D5		
CVLM	J3	LSTR	J6	SFB	E13	WCA	D7		
CVLR	J3			SHCLP34	K6	WEP	D11		
				SHCLPLK	K6	WF	D11		
						WFC	D11		

Notes

The Merillat logo consists of a dark, stylized shape resembling a mountain range or a series of peaks. The word "Merillat" is written in a white, serif font across the center of this shape.

We are America's Cabinetmaker.®

Masco Cabinetry LLC 25 Year Limited Warranty.

Masco Cabinetry LLC warrants to the original consumer purchaser that our Merillat Express® cabinetry will be free from defects in material and workmanship under normal use for a period of TWENTY-FIVE (25) YEARS from date of purchase. This warranty is not transferable. No changes or modifications can be made to this warranty except by an officer of Masco Cabinetry LLC.

Masco Cabinetry LLC may elect to repair or replace any defective Merillat Express® product covered by our warranty.
THIS WARRANTY DOES NOT COVER:

- The natural aging or darkening of wood color, or the inherent growth characteristics of, or variation, in wood.
- Defects caused by misuse, abuse, negligence, alterations, environmental conditions, improper installation, storage or handling.

As with other natural materials, wood is affected by environmental factors such as natural and artificial lighting. Darkening or mellowing of the wood can be expected and is a natural process of wood as it ages. Each wood species also exhibits its own distinctive patterns and characteristics that add to its natural beauty. These variations in color and characteristics are not considered imperfections or defects.

Masco Cabinetry LLC further provides a Lifetime Limited Warranty on the door hinges and drawer guides to the original consumer purchaser for as long as you own the product. This Lifetime Limited Warranty provides that the door hinges and drawer glides will be free from defects in material and workmanship under normal use. Replacement hinges and drawer glides are subject to their availability from our suppliers.

From time to time, we will change design, specifications and materials as conditions require and improvements are developed, but we have no obligation to incorporate such changes in products we previously manufactured.

TO THE MAXIMUM EXTENT PERMITTED BY APPLICABLE LAW, THIS WARRANTY DOES NOT COVER INDIRECT, SPECIAL, INCIDENTAL, OR CONSEQUENTIAL DAMAGES, LOSS OF USE, OR LABOR EXPENSES IN UNINSTALLING OR INSTALLING ANY MATERIAL OR PARTS, WHETHER ARISING OUT OF BREACH OF WARRANTY, BREACH OF CONTRACT, NEGLIGENCE, TORT, OR ANY OTHER LEGAL THEORY, EVEN IF MASCO CABINETRY LLC HAS BEEN ADVISED OF THE POSSIBILITY THEREOF. MASCO CABINETRY LLC DISCLAIMS RESPONSIBILITY FOR DAMAGES IN EXCESS OF YOUR PURCHASE PRICE. Some provinces and some states do not allow the exclusion or limitation of incidental or consequential damages, so the above limitation or exclusion may not apply to you.

This warranty is only valid in the United States of America and Canada. This warranty gives you specific legal rights, and you may also have other rights which vary from state to state and from province to province.

To obtain performance under this warranty, you must contact your Merillat Express® supplier and report, in writing, all defects claimed and provide your original sales receipt or other documentation acceptable to Masco Cabinetry LLC. If you have difficulty obtaining assistance, write to: Merillat Express® Warranty Department, Masco Cabinetry LLC, 15535 South State Ave. Middlefield, Ohio 44062 USA.

For Merillat Express® cabinetry purchased on or after May 18, 2015.



We are America's Cabinetmaker.®

MERILLAT.COM

