

HAND TOOLS

Würth Baer Supply



Contents

4 - 15	WRENCHES
16 - 17	ALLEN KEYS
18	RIVETERS
19 - 28	SCREWDRIVERS
29 - 32	T-HANDLES
33 - 35	BITS
36 - 37	RATCHETS
38 - 53	SOCKETS
54 - 65	PLIERS/CUTTERS
66	LIMITED EDITION SETS



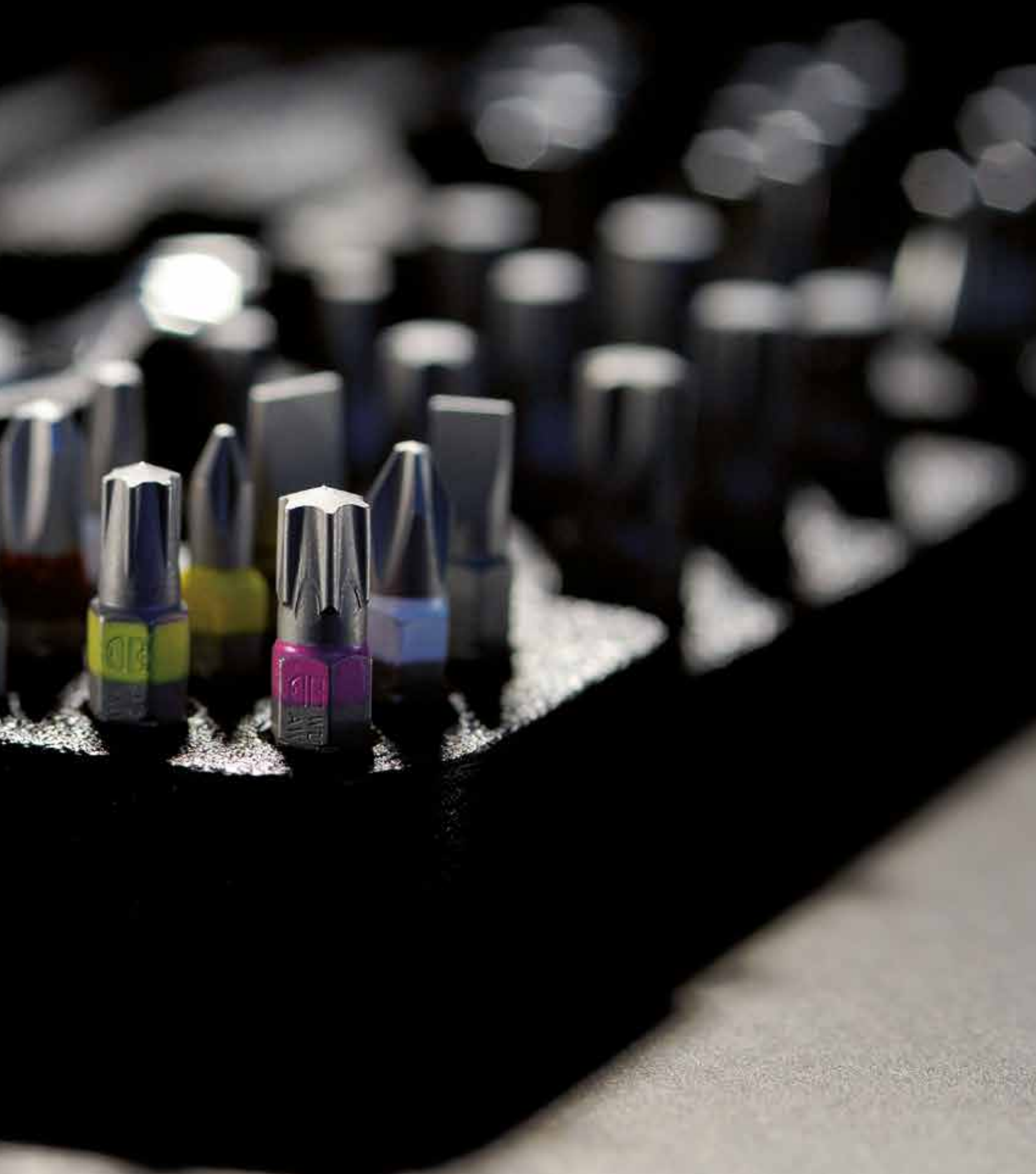

ZEBRA POWERDRIV® COMBINATION WRENCH - EXTRA SLIM

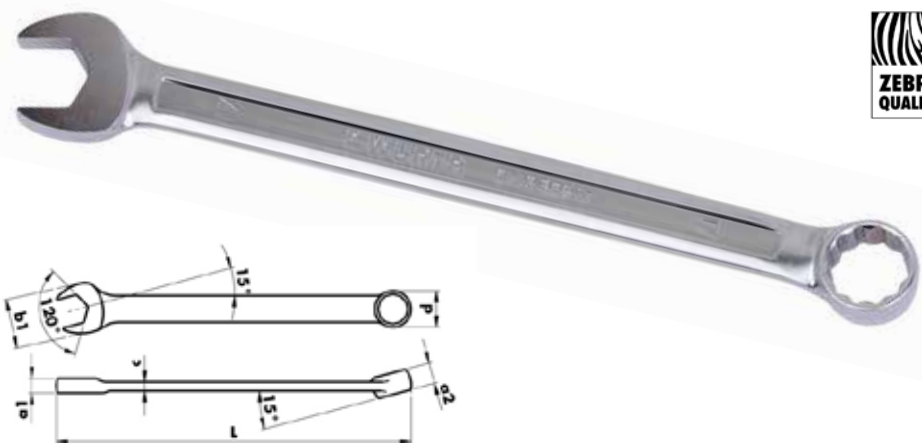

Metric, ultra slim shape

Allows for easy access and usability in hard-to-reach places

- Drive: Box end **POWERDRIV®** 12 point.
 - Standard: DIN 3113A / ISO 3318/7738
 - Geometry: Box end 15 ° angled, open-end position 15 °
 - Material: Chrome vanadium steel
 - Surface: Chrome-plated, matte satin finish
- Packing & Sold in: Each

Item #	 (mm)	L (mm)	a1 (mm)	a2 (mm)	b (mm)	c (mm)	Dia. d (mm)
WW071330908	8	139	4.2	6.5	14.7	2.6	12
WW071330916	16	206	7	12.1	29.2	4.3	22.3
WW071330918	18	233	8	13.1	32.2	4.7	25.3
WW071330919	19	244		13.5	33.7	5	26.8

ZEBRA DOUBLE OPEN-END WRENCH ASSORTMENT



Metric

12 pieces, with plastic holder

- Standard: DIN 3110 / ISO 1085
- Material: Chrome-vanadium steel
- Surface finish: Chrome-plated polished heads
- Open-end position 15°, strong heads for heavy duty use

Packing & Sold in: Each

Item #	Set	in mm
WW071330443	12 pieces	6x7, 8x9, 10x11, 12x13, 14x15, 16x17, 18x19, 20x22, 21x23, 24x27, 25x28, 30x32

POWERDRIV® (12-POINT) DOUBLE BOX END WRENCH - EXTRA LONG



Universal joint shaft flange, axle, ball and suspension joints, axle linkages

For high tightening and release forces

- Metric
- Drive: Double box end **POWERDRIV®** 12-point
- Standard: Wrench size according to DIN 475 Part II
- Material: Chrome-vanadium steel
- Surface: Body chromed, matte satin
- Geometry: Straight, very slim box-end design for hard to reach places

Packing & Sold in: Each

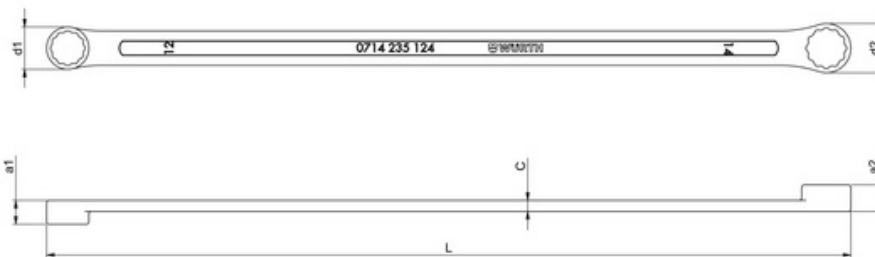

Item #	WW0714235101	WW0714235124	WW0714235135	WW0714235168	WW0714235179
Size	10 x 11 mm	12 x 14 mm	13 x 15 mm	16 x 18 mm	17 x 19 mm
Outside diameter d1	15 mm	17.2 mm	20 mm	22.6 mm	26 mm
Outside diameter d2	18.1 mm	20 mm	21.6 mm	26 mm	26.5 mm
Thickness a1	8 mm	9.7 mm	11 mm	12.3 mm	13.8 mm
Thickness a2	9 mm	10.8 mm	12 mm	13.3 mm	14 mm
Shank thickness c	4mm	4.5 mm	5 mm	5 mm	5.4 mm
Length l	292 mm	327 mm	367 mm	388 mm	410 mm

ZEBRA POWERDRIV® (12-POINT) COMBINATION WRENCH SET - SHORT TYPE (8 PIECES - 3/8, 7/16, 1/2, 9/16, 5/8, 11/16, 3/4, 7/8 INCH)



Standard

8 piece set

- Standard: DIN 3113A/ISO 3318/773
- Drive: Box end **POWERDRIV®** (12-Point)
- Material: Chrome-vanadium steel
- Surface: Chrome-plated, polished
- Geometry: Box end angled 15°, open end offset 15°

Packing & Sold in: Each

Item #	⚙️ (in.)
WW071330340	3/8, 7/16, 1/2, 9/16, 5/8, 11/16, 3/4, 7/8

ZEBRA POWERDRIV® COMBINATION WRENCH - SHORT TYPE

WRENCHES

ALLEN KEYS

RIVETERS

SCREWDRIVERS

T-HANDLES

BITS

RATCHETS

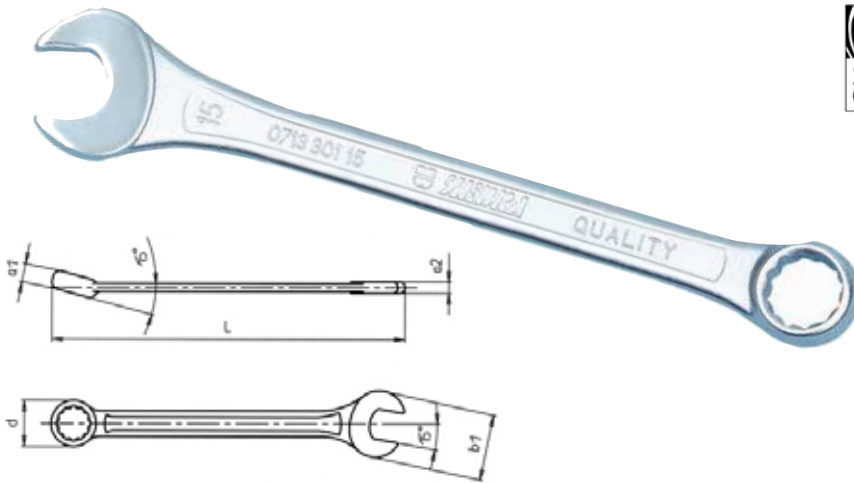

Metric

- Standard: DIN 3113A/ISO 3318/7738
- Drive: Box end **POWERDRIV®** (12-Point)
- Material: Chrome-vanadium steel
- Surface: Chrome-plated, polished heads and ring
- Geometry: Box end angled 15°, head angle 15°

Packing & Sold in: Each

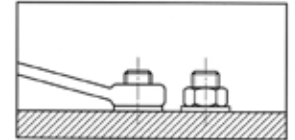
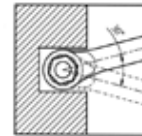

Item #	⌀ (mm)	L (mm)	b1 (mm)	Dia. d (mm)	a1 (mm)	a2 (mm)
WW0713301055	5.5	100	14.0	10.5	5.5	3.7
WW071330106	6					
WW071330107	7	110	16.0	11.8	6.0	4.0
WW071330108	8	120	18.0	13.2		
WW071330109	9	130	20.0	14.6	7.0	4.5
WW071330110	10	140	22.5	16.1	7.5	
WW071330111	11	150	25.0	17.4	8.0	5.0
WW071330112	12	160	27.0	18.9	8.5	5.5
WW071330113	13	170	29.0	20.4	9.0	
WW071330114	14	180	31.0	21.6	9.5	6.0
WW071330115	15	190	33.5	22.9	10.0	
WW071330116	16	200	36.0	24.6	10.5	6.5
WW071330117	17	205	38.0	26.1		
WW071330118	18	215	40.0	27.7	11.0	7.0
WW071330119	19	230	42.0	29.9	11.5	7.5
WW071330120	20	240	45.0	30.7	12.0	8.0
WW071330121	21	250	47.0	32.2	12.5	
WW071330122	22	260	49.0	33.7	13.5	
WW071330123	23	270	51.0	35.2	14.0	
WW071330124	24	280	53.0	36.9	14.5	9.0
WW071330125	25	290	55.0	38.5	15.0	
WW071330126	26	300	57.0	39.8	15.5	
WW071330127	27	310	59.0	40.8		
WW071330128	28	320	62.0	42.8	16.0	10.0
WW071330129	29	330	63.5	43.8	16.5	
WW071330130	30	340	65.0	44.8	17.0	11.0
WW071330132	32	350	69.0	47.8	17.5	
WW071330134	34	360	73.0	50.8	18.0	12.0



ZEBRA POWERDRIV® COMBINATION WRENCH - SHORT TYPE



Standard

- Standard: DIN 3113A/ISO 3318/773
 - Drive: Box end **POWERDRIV®**, 12-point
 - Material: Chrome-vanadium steel
 - Surface: Chrome-plated, polished
 - Geometry: Box end angled 15°, open-end offset 15°
- Packing & Sold in: Each

Item #	Ø (in.)	L (mm)	b1 (mm)	Ø d (mm)	α1 (mm)	α2 (mm)
WW071330303	3/8"	140	22.5	16.1	7.5	4.5
WW071330304	7/16"	150	25	17.4	8	5
WW071330305	1/2"	170	29	20.4	9	5.5
WW071330306	9/16"	180	31	21.6	9.5	6
WW071330307	5/8"	200	36	24.6	10	6
WW071330308	11/16"	205	38	26.1	10.5	6.5
WW071330309	3/4"	230	42	29.9	11.5	7.5
WW071330311	7/8"	260	49	33.7	13.5	8

ZEBRA POWERDRIV® COMBINATION WRENCH ASSORTMENT - SHORT TYPE



Metric

11 pieces, with plastic holder

- Box end **POWERDRIV®** (12 point)
- Standard: DIN 3113A/ISO 3318/7738
- Material: Chrome-vanadium steel
- Surface Finish: Chrome-plated polished heads
- Open-end position 15°, strong heads for heavy duty use
- 12-Point box-end and open-end position of 15° for an optimal grip ratio, resulting in minimal rotating angle
- The 15° angle of the box end provides more free space for the fingers or to work around obstacles

Packing & Sold in: Each

Item #	Set	Ø (mm)
WW071330140	11 pieces	8, 9, 10, 11, 12, 13, 14, 15, 17, 19, 22

ZEBRA POWERDRIV® (12-POINT) DUAL RATCHET COMBINATION WRENCH



Innovative wrench with ratchet function on the box and open sides.

- Drive: Box end POWERDRIV® modified 12 point, open side with open ratchet segment
- Standard: Max. torque as per DIN 899
- Material: Chrome-vanadium steel
- Surface: polished, chrome-plated
- Geometry: Straight on box end, 15° angle on open end
- To change the turning direction, simply turn the wrench around
- Open side features moving ratchet segment
- Enables working without stopping, as the wrench no longer needs to be taken off the nut. Ideal for all line screw joints
- Fine-toothed on ring side, 72 teeth, 5° rotating angle
- Very rugged and strong ratchet for high tightening torques

Packing & Sold in: Each



Areas of use

- Designed for union screw joints, e.g. brake lines, injection lines, air conditioning, hydraulics etc.

Item #	C (mm)					
		L (mm)	a1 (mm)	a2 (mm)	Dia. d (mm)	b1 (mm)
WW071425908	8	140	4.1	6.5	16.8	16.7
WW071425909	9	149	4.3	6.9	18.8	18.7
WW071425910	10	158	4.8	7.3	20.8	20.8
WW071425911	11	165	5.1	7.7	21.8	23.5
WW071425912	12	171	5.3	8.2	22.8	24.6
WW071425913	13	178	5.9	8.6	24.8	26.8
WW071425914	14	190	6.3	9.0	27.8	29.0
WW071425915	15	199	6.6	9.4	28.8	31.0
WW071425916	16	208	6.9	9.9	30.8	33.0
WW071425917	17	225	7.3	10.3	31.8	35.5
WW071425918	18	236	7.8	10.7	32.8	37.5
WW071425919	19	247	8.3	11.2	33.8	39.4
WW071425921	21	289	8.8	13.0	40.0	45.8
WW071425922	22					
WW071425924	24	322	9.8	14.5	46.0	51.8

ZEBRA POWERDRIV® (12-POINT) DUAL RATCHET COMBINATION WRENCH ASSORTMENT



Innovative wrench with ratchet function on the box and open ends

6 pieces, with plastic holder

- 1 ratchet combination wrench with double-ended ratchet function in each of the following sizes: 8; 10; 12; 13; 17; 19

Packing & Sold in: Each

Item #	Set	C (mm)
WW071425950	6 pieces	8, 10, 12, 13, 17, 19 mm including plastic holder

ZEBRA POWERDRIV® RATCHET COMBINATION WRENCH - FLEXIBLE JOINT



Flexible joint ratchet head provides greater freedom for fingers and overcomes obstacles

- Very rugged, strong ratchets for high tightening torques
- Design: Metric
- Drive: Box end POWERDRIV® 12-point, fine-tooth 72 teeth
- Standard: Max. torque in line with DIN 899
- Material: Chromium-vanadium steel
- Surface: Chrome-plated, matte satin finish
- Geometry: Open-end offset 15°, box end 180° joint, strong heads for heavy-duty applications

Packing & Sold in: Each



The 180° flexible joint of the box end of the wrench allows for easy access to tight areas.

Attention: This is a special tool that may not be subjected to loads in excess of maximum torque values. For that reason, the tool is of limited suitability for loosening of tight screws.

Item #	(mm)						
		L (mm)	a1 (mm)	a2 (mm)	d (mm)	b1 (mm)	F max. Nm
WW071426308	8	140	4.3	6.5	16.1	16.7	35
WW071426309	9	150	4.6	6.9	17.9	18.8	46
WW071426310	10	159	5.0	7.3	19.6	20.9	59
WW071426311	11	165	5.4	7.7	21.4	23.0	74
WW071426312	12	172	5.8	8.2	22.7	25.1	91
WW071426313	13	178	6.1	8.6	24.7	27.2	109
WW071426314	14	191	6.4	9.0	26.4	29.3	131
WW071426315	15	200	6.9	9.4	27.7	31.3	153
WW071426316	16	208	7.2	9.9	29.4	33.4	179
WW071426317	17	226	7.6	10.3	31.2	35.5	205
WW071426318	18	237	8.0	10.7	32.4	37.6	235
WW071426319	19	248	8.6	11.2	33.4	39.7	266
WW071426321	21	274	9.0	13.0	39.7	46.0	330
WW071426322	22						368
WW071426324	24	296	10.0	14.5	45.9	52.3	451

ZEBRA POWERDRIV® RATCHET COMBINATION WRENCH ASSORTMENT - FLEXIBLE JOINT



Flexible Joint

6 pieces, with plastic holder

- 1 ratchet combination wrench in each of the following sizes: 8; 10; 12; 13; 17; 19

Packing & Sold in: Each

Item #	Set	(mm)
WW071426350	6 pieces	8, 10, 12, 13, 17, 19 mm

ZEBRA HEXAGON POWERDRIV® DOUBLE OPEN END LINE WRENCH



Metric

- Drive: Hexagon **POWERDRIV®**
 - Standard: DIN 3118
 - Geometry, open end profile angled 15°, open end angled 5°
 - Material: Chrome-vanadium steel
 - Surface: Chrome-plated, polished heads
- Packing & Sold in: Each



Item #	○ ● (mm)								
		L (mm)	a1 (mm)	a2 (mm)	Dia. d1 (mm)	Dia. d2 (mm)	B1 min. (mm)	B2 min. (mm)	
WW0714240079	7 x 9	140	6.5	7.5	17.8	19.3	5	7	
WW0714240080	8 x 10						6		
WW0714240113	11 x 13	174	8.5	10.5	22.8	25.3	9	11	
WW0714240124	12 x 14								
WW0714240179	17 x 19	212	12	13	31.2	33.3	14	15	

ZEBRA HEXAGON POWERDRIV® DOUBLE OPEN END LINE WRENCH ASSORTMENT



Metric

5 pieces, with plastic holder

- Drive: Hexagon **POWERDRIV®**
- Standard: DIN 3118
- 1 each of double open end ring wrench size: 7 x 9, 8 x 10, 11 x 13, 12 x 14, 17 x 19
- Packing & Sold in: Each



Item #	Set	○ ● (mm)
WW071424050	5 pieces	7 x 9, 8 x 10, 11 x 13, 12 x 14, 17 x 19

WRENCHES
ALLEN KEYS
RIVETERS
SCREWDRIVERS
T-HANDLES
BITS
RATCHETS



0713 308 22

0713 308 22

0713 308 22

EF

0713 308 22

ZEBRA POWERDRIV® (12-POINT) DOUBLE BOX END WRENCH - DEEP OFFSET

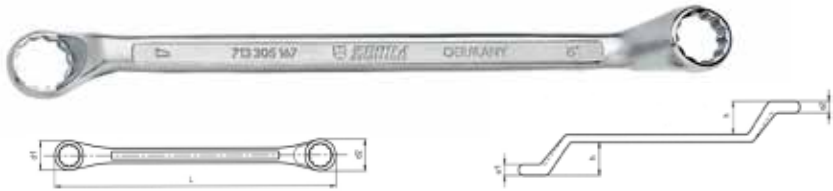

Metric, DIN 838/ISO 3318

- Drive: **POWERDRIV®**, 12 point
- Material: Chrome-vanadium steel
- Surface: Chrome-plated, polished
- Geometry: Box ends offset 18°

Packing & Sold in: Each

Item #	⌀ (mm)	L (mm)	a1 (mm)	a2 (mm)	dia. d1 (mm)	dia. d2 (mm)	h (mm)
WW0713305067	6x7	174	5.4	5.9	10.8	12.2	21
WW0713305089	8x9	187	6.4	6.9	13.2	14.7	23
WW0713305080	8x10	188	6.9	7.9		16.3	
WW0713305101	10x11	194	7.4	7.9	16.3	17.4	23.5
WW0713305103	10x13	215	7.9	9.9	16.3	20.7	24.5
WW0713305123	12x13	217	8.4	9.5	19.0	20.7	25
WW0713305137	13x17	243	9.9	11.8	20.7	26.2	27.5
WW0713305145	14x15	227		10.3	22.1	23.4	
WW0713305167	16x17	247	10.8	11.3	25.4	26.2	28
WW0713305168	16x18	250	11.3	11.8	25.6	28.2	
WW0713305179	17x19	284			28.0	29.4	29.5
WW0713305189	18x19		30				
WW0713305202	20x22	296	11.8	12.8	31.2	33.1	31
WW0713305213	21x23	312	12.3		32.1	35.5	
WW0713305224	22x24	313	12.8	14.3	37.0	37.0	34
WW0713305246	24x26	328		13.8		39.0	
WW0713305247	24x27	329		14.3	41.0		
WW0713305258	25x28	339	13.8	14.8	37.8	42.0	37
WW0713305279	27x29	342	14.8	15.8	41.0	44.3	36.3
WW0713305302	30x32	359			45.0	48.2	39
WW0713305304	30x34	397	15.8	16.7	45.3	51.2	

ZEBRA POWERDRIV® (12-POINT) DOUBLE BOX END WRENCH SETS - DEEP OFFSET



- Drive: **POWERDRIV®** (12-point)
- Material: Chrome-vanadium steel
- Surface: Chrome-plated, polished
- Geometry: Box end offset 18°

Packing & Sold in: Each



Item # WW071330540

Metric, DIN 838/ISO 3318, 8 pieces

- Sizes (in mm) 6x7, 8x9, 10x11, 12x13, 14x15, 16x17, 18x19, 20x22

Item # WW071330541

Metric, DIN 838/ISO 3318, 10 pieces

- Sizes (in mm) 8x9, 10x11, 12x13, 14x15, 16x17, 18x19, 20x22, 21x23, 24x27, 30x32

Item # WW071330542

Metric, DIN 838/ISO 3318, 12 pieces

- Sizes (in mm) 6x7, 8x9, 10x11, 12x13, 14x15, 16x17, 18x19, 20x22, 21x23, 24x27, 25x28, 30x32

ZEBRA POWERDRIV® (12-POINT) DOUBLE BOX END RATCHET WRENCH - 4-IN-1



Metric, straight

- Output: Double box end **POWERDRIV®** (12-point)
- Finely toothed, 72 teeth
- Single-handed operation via reversing lever for clockwise and counterclockwise rotation
- Material: Chrome-vanadium steel
- Basic body surface: chrome-plated, high-gloss polished
- Geometry: Straight box end

4 sizes in one ratchet wrench

- Most common wrench sizes are covered by only 2 ratchet wrench

1/4" bit adapter available

- Simply insert into size 10 mm ratchet wrench to use as a bit ratchet

For hard-to-access areas

- Narrow ratchet head
- Packing & Sold in: Each

Item #	(mm)							
		L (mm)	a1 (mm)	a2 (mm)	b1 (mm)	b2 (mm)	d1 (mm)	d2 (mm)
WW0714257013	8x10 + 12x13	150	7.3	8.6	13.8	16.8	20.2	24.8
WW0714257017	10x19 + 13x17	200	9.0	11.2	17.1	21.9	27.2	33.6
WW0714257019	16x17 + 18x19	230	10.3		20.2		31.5	33.5

ZEBRA POWERDRIV® (12-POINT) DOUBLE BOX END RATCHET WRENCH SET 4-IN-1 (3 PIECES)



Innovative double-sided, double-ended ratcheting wrench.

- Drive: Double-box end **POWERDRIV®** 12-point, fine-toothed, 72 teeth, one-hand operation via reversing lever for clockwise and counterclockwise use
- Material: Chrome-vanadium steel
- Surface: Chrome-plated, high gloss polish
- Geometry: box end straight
- Four sizes per ratchet wrench; the most common sizes are covered by only two ratchet wrenches
- 1/4" bit adapter available: simply insert in size 10 mm ratchet wrench, can then be used as a bit ratchet
- Narrow ratchet head for hard-to-reach areas

Packing & Sold in: Each

5° angle of rotation for working in the tightest of spaces. Precision-machined ring core for smooth and secure use.

Item #	Set (comes in a clear plastic blister pack)	(mm)	Finish
WW071425730	3 pieces	8 x 10 + 12 x 13, 16 x 17 + 18 x 19 Bit adapter: 10 mm 1/4", 20 mm long	Chrome
WW0714257300	3 pieces	8 x 10 + 12 x 13, 16 x 17 + 18 x 19 Bit adapter: 10 mm 1/4", 20 mm long	Black Chromium

ZEBRA DOUBLE OPEN-ENDED WRENCH ASSORTMENT - METRIC



Item # **WW0965900404**

8 Pieces

Contents:

Size (in mm)

- 6 x 7, 8 x 9, 10 x 11, 12 x 13, 14 x 15, 16 x 17, 18 x 19, 20 x 22
- Includes foam insert

ZEBRA COMBINATION WRENCH ASSORTMENT - METRIC



Item # **WW0965900403**

11 Pieces

Contents:

Size (in mm)

- 8, 9, 10, 11, 12, 13, 14, 15, 17, 19, 22
- Includes foam insert

ZEBRA COMBINATION WRENCH ASSORTMENT - METRIC

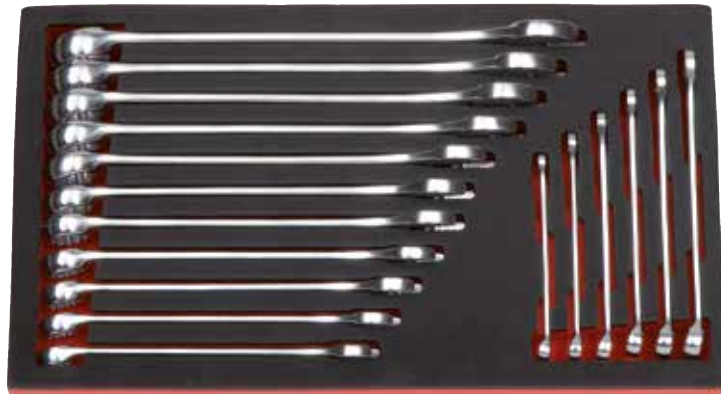

Item # **WW0965900401**

17 Pieces

Contents:

Size (in mm)

- 6, 7, 8, 9, 10, 11, 12, 13, 14, 15, 16, 17, 18, 19, 20, 21, 22
- Includes foam insert



ZEBRA
0613 430 214

1/4" 215mm

1/2" 125mm

21

22

24

26

15

16

17

18

14

13

12

11

10

9

8

ZEBRA ALLEN KEYS

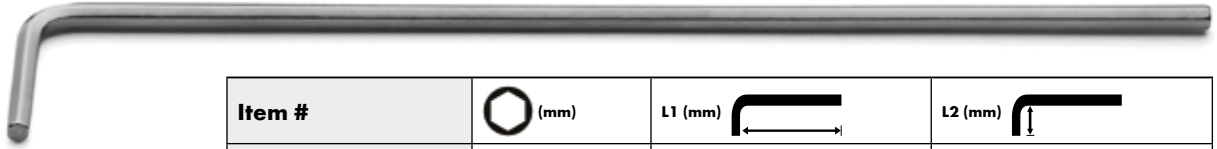

Long version

- Bright nickel-plated
 - Chamfered front edges
- Packing & Sold In: Each



Item #	⊘ (mm)	L1 (mm)	L2 (mm)
WW07153118	2.5	115	21
WW07153119	3.0	129	23
WW07153120	4.0	144	29
WW07153121	5.0	165	33
WW07153122	6.0	186	38
WW07153123	7.0	197	41
WW07153124	8.0	208	44
WW07153125	9.0	219	47
WW07153126	10.0	234	50
WW07153127	11.0	238	53
WW07153128	12.0	262	57
WW07153129	14.0	294	70
WW07153130	17.0	337	80

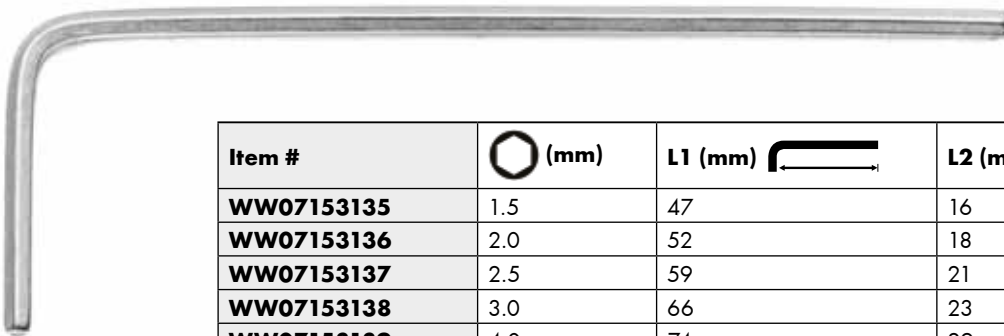

Short version

- Bright nickel-plated
 - Chamfered front edges
- Packing & Sold In: Each



Item #	⊘ (mm)	L1 (mm)	L2 (mm)
WW07153135	1.5	47	16
WW07153136	2.0	52	18
WW07153137	2.5	59	21
WW07153138	3.0	66	23
WW07153139	4.0	74	29
WW071531391	4.5	80	31
WW07153140	5.0	85	33
WW071531401	5.5	90	35
WW07153141	6.0	96	38
WW07153142	7.0	102	41
WW07153143	8.0	108	44
WW07153144	9.0	114	47
WW07153146	11.0	129	53
WW07153147	12.0	137	57
WW07153148	14.0	154	70
WW071531481	16.0	168	73
WW07153149	17.0	177	80
WW07153150	19.0	199	89
WW07153151	22.0	222	102

WRENCHES
ALLEN KEYS
RIVETERS
SCREWDRIVERS
T-HANDLES
BITS
RATCHETS

ZEBRA ALLEN KEY ASSORTMENTS



9 pieces, in plastic holder, short version

- Bright nickel-plated
- Chamfered front edges

Item #	Set	Contents (mm)
WW071531100	9-pcs	1.5, 2, 2.5, 3, 4, 5, 6, 8, 10

10 pieces, in plastic holder, short version

- Bright nickel-plated
- Chamfered front edges

Item #	Set	Contents (mm)
WW071531110	10-pcs	1.5, 2, 2.5, 3, 4, 5, 6, 8, 10, 12

9 pieces, in plastic holder, long version

- Bright nickel-plated
- Chamfered front edges

Item #	Set	Contents (mm)
WW071531120	9-pcs	1.5, 2, 2.5, 3, 4, 5, 6, 8, 10



ZEBRA TORX ALLEY KEY ASSORTMENT



8 pieces, in plastic holder

- TX socket
- Round blade
- Bright nickel-plated



Item #	Set	Contents
WW071536100	8-pcs	TX 9, 10, 15, 20, 25, 27, 30, 40

ZEBRA HAND HELD RIVET PLIERS WITH LONG NOSE PIECE FOR INSTALLING BLIND RIVETS



Item # WW091511

Universal, hand-held steel riveting pliers with exchangeable mouth pieces for the installation of commercial rivets made of aluminum, copper, steel and stainless steel

Features

- With long nose piece for installing aluminum, copper, steel and stainless steel blind rivets: \varnothing 3.2 mm, 4 mm, 4.8 mm
- Length of nose piece: 52 mm
- Diameter nose piece adapter: 19 mm

Technical data

Length, nose piece mounting (including nose piece)	52mm
Diameter, nose piece mounting	19mm

HAND HELD RIVETER FOR INSTALLING BLIND RIVETS

Item # WW094915

Hand-held riveter for installing blind rivets \varnothing 2.4 mm, 3 mm and 4 mm made of aluminum, copper, steel and stainless steel and blind rivets \varnothing 5 mm made of aluminum

Technical data

Length, nose piece mounting (including nose piece)	260mm
--	-------



ZEBRA PISTOL GRIP RATCHET SCREWDRIVER WITH 6 BIT MAGAZINE (BITS NOT INCLUDED)



High-performance ratchet screwdriver

- High-performance ratchet screwdriver
- 3-position adjustment wheel, adjustable with one hand, easy to change direction while working without using the other hand
- Magnet ensures a secure grip on bits and screws
- 45 teeth, max. torque of up to 40 Nm
- 2K grip for optimum ergonomic work
- Can be used as a standard screwdriver in the straight position or as a pistol grip in the 60° position thanks to the adjustable handle LED technology
- Working area is always well lit, lights the screw directly
- Especially suitable for dark areas
- Blade: Short bit holder blade with magnet, brushed chrome-plated
- Output: DIN 3126-D 6.3
- Sealing cap with bit magazine for a total of 6 bits (bits not included)

Packing & Sold In: Each

Item #	Designation	Length (mm)
1/4" Bits		
WW0613714	Telesc. magn. holding	150 - 530 mm

Item #	(in.)	A1 (mm)	A2 (mm)	A3 (mm)	B (mm)	C (mm)	D (mm)
WW06136400	1/4"	10	37	40	25	26	113

ZEBRA 3K HEX BLADE PHILLIPS HEAD SCREWDRIVER



Flexible 3K handle ensures perfect ergonomics, force transmission and working comfort

Screwdriver, Phillips Head

- Blade: One-piece hexagon blade, brushed chrome-plated; wrench adapter matte nickel-plated, tempered, impact-resistant
 - Würth color coding system
 - Large impact cap
 - Tip: DIN 5260-PH, ISO 8764-PH with black point tip
- Packing & Sold In: Each

Item #	+			 (mm)	 (in.)
		A (mm)	B/C (mm)		
WW06132011	PH 1	80	96/31	5/8	3 1/8"
WW06132012	PH 2	100	106/35	6/10	4"
WW06132013	PH 3	150	114/38	8/13	6"

ZEBRA 3K HEXAGON BLADE SLOTTED HEAD SCREWDRIVER

Flexible 3K handle ensures perfect ergonomics, force transmission and working comfort.



Screwdriver, flat slotted

- Blade: One-piece hexagon blade, brushed chrome-plated; torque adjustment matte nickel-plated, tempered, impact-resistant
- Large impact cap
- Output: DIN 5264-A, ISO 2380 with black point tip

Packing & Sold In: Each

Item #	A (mm) / B (mm)	A (mm) / B/C (mm)		Hexagon (mm)	A (in.)
		A (mm)	B/C (mm)		
WW0613200035	0.6 x 3.5	80	83/27	4/-	1/8 x 3 1/16"
WW0613200045	0.8 x 4.5	90	96/31	5/8	3/16 x 3 3/5"
WW0613200055	1.0 x 5.5	100	96/31	6/10	7/32 x 4"
WW061320007	1.2 x 7.0	125	106/35	6/10	9/32 x 5"
WW061320009	1.6 x 9.0	150	114/38	8/13	11/32 x 6"
WW061320010	1.6 x 10.0	175	114/38	8/13	3/8 x 7"
WW061320012	2.0 x 12.0	200	114/38	10/16	1/2 x 8"

ZEBRA 3K SLOTTED AND PHILLIPS HEAD SCREWDRIVER SET - 5 PIECES



5 pieces, with three slotted and two Phillips head screwdrivers for the automotive and metalwork trades

- Flexible 3K handle ensures perfect ergonomics, power transmission and working comfort
- Impact caps

Packing & Sold In: Each

Item #	Contents	⊖	⊕
WW06139015	5-pc. set	1.0x5.5 / 1.2x7.0 / 1.6x9.0 mm	PH 1 PH 2



ZEBRA® 3K HANDLE

The flexible 3-component handle ensures an optimal, sensitive seat in the hand and allows connection with the robust design also the highest power transmission.

WRENCHES
ALLEN KEYS
RIVETERS
SCREWDRIVERS
T-HANDLES
BITS
RATCHETS

ZEBRA 3K TORX SCREWDRIVER SET (6 PIECES)



Item # **WW06139036** 6 piece set



6 pieces, with flexible 3K handle for perfect ergonomics, power transmission and operating comfort

- Blade: Round, brushed chrome-plated
- Tip: TX socket with black point tip
- Würth color coding system
- Screw symbol printed on handle end for quick identification

Packing & Sold In: Each

			 (in.)
	A (mm)	B/C (mm)	
TX 8	60	83/27	2 3/8"
TX 10	80	96/31	3 1/8"
TX 15			
TX 20	100	106/35	4"
TX 25			
TX 30	115		4 9/16"

ZEBRA SLOTTED SCREWDRIVER - ROUND BLADE



Round blade

- Blade: Matte chrome-plated
- Tip: DIN 5264-A, ISO 2380, black point tip
- Standard: DIN 5265

Packing & Sold In: Each

Item #				 (in.)
		A (mm)	B/C (mm)	
WW061323103	0.5 x 3.0	80	73/20	1/8" x 3 1/8"
WW0613231065	1.2 x 6.5	150	106/35	1/4" x 6"
WW061323110	1.6 x 10.0	200	114/38	3/8" x 8"

ZEBRA SLOTTED SCREWDRIVER - ROUND BLADE, SHORT



Round blade, short

- Blade: Matte chrome-plated
- Tip: DIN 5264-A, ISO 2380, black point tip
- Standard: DIN 5265

Packing & Sold In: Each

Item #				 (in.)
		A (mm)	B/C (mm)	
WW061325108	1.2 x 8.0	25	62/31	5/16 x 1"

ZEBRA SLOTTED SCREWDRIVER - HEXAGON BLADE, IMPACT CAP, WRENCH ADAPTER



Hexagon blade, impact cap

- Large impact cap
 - Tip: DIN 5264-A, ISO 2380, black point tip
 - Wrench adapter
- Packing & Sold In: Each

Item #				 (mm)	 (in.)
		A (mm)	B/C (mm)		
WW0613321045	0.8 x 4.5	90	96/31	5 / 8	3/16 x 3 3/5"
WW0613321055	1.0 x 5.5	100		6 / 10	7/32 x 4"
WW061332107	1.2 x 7.0	125	106/35	8 / 13	9/32 x 5"
WW061332109	1.6 x 9.0	150	114/38		11/32 x 6"
WW061332110	1.6 x 10.0	175		120/40.5	10 / 16
WW061332112	2.0 x 12.0	200	120/40.5		10 / 16
WW061332114	2.5 x 14.0	250		120/40.5	10 / 16

ZEBRA SLOTTED SCREWDRIVER - HEXAGON BLADE, WRENCH ADAPTER



Hexagon blade and wrench adapter

- Blade: Matte chrome-plated
 - Tip: DIN 5264-A, ISO 2380, black point tip
- Packing & Sold In: Each

Item #				 (mm)	 (in.)
		A (mm)	B/C (mm)		
WW0613421035	0.6 x 3.5	80	83/27	4 / -	1/8 x 3 1/16"
WW0613421004	0.8 x 4.0	90	96/31	5 / 8	5/32 x 3 5/8"
WW0613421055	1.0 x 5.5	100			7/32 x 4"
WW0613421065	1.2 x 6.5	125	106/35	6 / 10	1/4 x 5"
WW061342108	1.6 x 8.0	150	114/38	8 / 13	5/16 x 6"
WW061342110	1.6 x 10.0	175			3/8 x 7"
WW061342112	2.0 x 12.0	200	120/40.5	10 / 16	1/2 x 8"

ZEBRA SLOTTED SCREWDRIVER - HEXAGON BLADE, LASER-CUT TIP



Laser-cut tip profile

Laser-cut blade tip for a sharp-edged surface structure



Laser-cut tip, hexagon blade

- Ultra-secure seating of screwdriver in screw head
- Better screw grip for improved torque transfer
- Less slippage means improved safety as well as less damage to screws and sensitive surfaces

- No repeated placement when screwing
 - Blade: Brushed chromium-plated
 - Tip: DIN 5264-A, ISO 2380, laser-cut tip, Black Point Tip
- Packing & Sold In: Each

Item #	 (mm)			 (mm)	 (in.)
		A (mm)	B/C (mm)		
WW0613424035	0.6 x 3.5	75	83/27	4 / -	1/8 x 3 1/16"
WW061342404	0.8 x 4.0	90	96/31		5/32 x 3 5/8"
WW0613424055	1.0 x 5.5	100		106/35	5 / 8
WW0613424065	1.2 x 6.5	125	106/35	6 / 10	1/4 x 5"
WW061342408	1.6 x 8.0	150	114/38	8 / 13	5/16 x 6"
WW061342410	1.6 x 10.0	175			114/38

ZEBRA PHILLIPS HEAD SCREWDRIVER - HEXAGON BLADE - IMPACT CAP - WRENCH ADAPTER



Hexagon blade, impact cap, wrench adapter

- Large impact cap
 - Tip: DIN 5260-PH, ISO 8764-PH, black point tip
 - Standard: DIN 5262, SMS SS 2831
- Packing & Sold In: Each

Item #	+			 (mm)	 (in.)
		A (mm)	B/C (mm)		
WW06133221	PH 1	80	96/31	5 / 8	3 1/8"
WW06133222	PH 2	100	106/35	6 / 10	4"
WW06133223	PH 3	150	114/38	8 / 13	6"
WW06133224	PH 4	200	120/40.5	10 / 16	8"

ZEBRA PHILLIPS HEAD SCREWDRIVER - ROUND BLADE - SHORT



Round blade, short

- Blade: Matte chrome-plated
 - Tip: DIN 5260-PH, ISO 8764-PH, black point tip
 - Standard: DIN 5262, SMS SS 2831
- Packing & Sold In: Each

Item #	+			 (in.)
		A (mm)	B/C (mm)	
WW06132521	PH 1	25	62/31	1 3/4"
WW06132522	PH 2			

ZEBRA PHILLIPS HEAD SCREWDRIVER - ROUND BLADE



Round blade

- Blade: Matte chrome-plated
 - Tip: DIN 5260-PH, ISO 8764-PH, black point tip
 - Standard: DIN 5262, SMS SS 2831
- Packing & Sold In: Each

Item #	+			 (in.)
		A (mm)	B/C (mm)	
WW061323201	PH 1	80	96/31	3 1/8"
WW061323202	PH 2	100	106/35	4"
WW061323203	PH 3	150	114/38	6"
WW061323204	PH 4	200	120/41	8"

ZEBRA PHILLIPS HEAD SCREWDRIVER - HEXAGON BLADE - WRENCH ADAPTER



Hexagon blade, wrench adapter

- Blade: Matte chrome-plated
 - Tip: DIN 5260-PH, ISO 8764-PH, black point tip
- Packing & Sold In: Each

Item #	PH 1 PH 2 PH 3 PH 4	A (mm) B/C (mm)		Hexagon (mm)	A (in.)
		A (mm)	B/C (mm)		
WW06134221	PH 1	80	96/31	5 / 8	3 1/8"
WW06134222	PH 2	100	106/35	6 / 10	4"
WW06134223	PH 3	150	114/38	8 / 13	6"
WW06134224	PH 4	200	120/40.5	10 / 16	8"

ZEBRA PHILLIPS HEAD SCREWDRIVER - LASER-CUT TIP - HEXAGON BLADE - WRENCH ADAPTER



Laser-cut tip, hexagon blade, wrench adapter

- Ultra-secure seating of screwdriver in screw head
 - Better screw grip for improved torque transfer
 - Less slippage means improved safety as well as less damage to screws and sensitive surfaces
 - No repeated placement when screwing
 - Blade: Brushed chrome-plated
 - Tip: DIN 5260-PH, ISO 8764-PH, laser-cut tip, black point tip
- Packing & Sold In: Each



Laser-cut tip profile
Laser-cut blade tip for a sharp-edged surface structure

Item #	PH 1 PH 2 PH 3	A (mm) B/C (mm)		Hexagon (mm)	A (in.)
		A (mm)	B/C (mm)		
WW06134251	PH 1	80	96/31	5 / 8	3 1/8"
WW06134252	PH 2	100	106/35	6 / 10	4"
WW06134253	PH 3	150	114/38	8 / 13	6"

ZEBRA TORX SCREWDRIVER - ROUND BLADE



- Blade: Round blade, matte chrome-plated
 - Tip: TX socket, black point tip
- Packing & Sold In: Each

Item #	TX 10 TX 15 TX 20 TX 25 TX 27 TX 30 TX 40 TX 45	Blade Length (mm)
WW061343410	TX 10	80
WW061343415	TX 15	
WW061343420	TX 20	100
WW061343425	TX 25	
WW061343427	TX 27	115
WW061343430	TX 30	
WW061343440	TX 40	130
WW061343445	TX 45	

ZEBRA TORX SCREWDRIVER - ROUND BLADE - LONG LENGTH



- Blade: Round blade, matte chrome-plated
 - Tip: TX socket, black point tip
- Packing & Sold In: Each

Item #				 (in.)
		A (mm)	B/C (mm)	
WW061346410	TX 10	250	83/27	10"
WW061346420	TX 20		96/31	
WW061346430	TX 30		106/35	

ZEBRA SCREWDRIVER SET - ROUND BLADE - PHILLIPS/SLOTTED HEAD - 6 PIECES



Item # **WW061392326** 6 piece set



- 0.6 x 3.5 x 100 mm, 1.0 x 5.5 x 125 mm, 1.2 x 6.5 x 150 mm, 1.2 x 8.0 x 175, PH1, PH2
- Packing & Sold In: Each

(mm)	
0.6 x 3.5 x 100	PH 1
1.0 x 5.5 x 125	PH 2
1.2 x 6.5 x 150	
1.2 x 8.0 x 175	

ZEBRA SCREWDRIVER SET - HEXAGON BLADE - PHILLIPS/SLOTTED HEAD - WITH WRENCH ADAPTER- 6 PIECES



Item # **WW061394226** 6 piece set



Hexagon blade and wrench adapter for automotive and metalwork trades

- Blade: Brushed chrome-plated
- 1 each of slotted screwdriver with hexagon blade and torque adjustment
- 0.6 x 3.5 x 75; 1.0 x 5.5 x 100; 1.2 x 6.5 x 125; 1.6 x 8.0 x 150
- 1 each of PH screwdriver with hexagon blade and torque adjustment PH 1; PH 2

Includes:

Item #	(mm)	Item #	
WW0613421035	0.6 x 3.5 x 75	WW06134221	PH 1
WW0613421055	1.0 x 5.5 x 100	WW06134222	PH 2
WW0613421065	1.2 x 6.5 x 125		
WW061342108	1.6 x 8.0 x 150		

Packing & Sold In: Each

ZEBRA TORX SCREWDRIVER ASSORTMENT - 7 PIECES



- 7 Screwdrivers: TX 10; 15; 20; 25; 27; 30; 40
- Foam drawer insert



7 Piece Set

Item #: WW0965900502

ZEBRA TORX SCREWDRIVER SET - 8 PIECES



- 1 Screwdriver set TX 8 pcs.
- Blade: Round blade, brushed chromium-plated, tip: TX socket, black point tip



8 Piece Set

Item #: WW06139348

	Blade length (mm)
TX 10	80
TX 15	
TX 20	
TX 25	100
TX 27	115
TX 30	
TX 40	130
TX 45	

ZEBRA MULTI SCREWDRIVER ASSORTMENT - 8 PIECES



- 6 screwdrivers with one-piece hexagon blade 0.6 x 3.5; 0.8 x 4.5; 1.2 x 7.0; 1.6 x 9.0; PH1; PH2
- 2 screwdrivers, short, PH1; PH2
- Foam drawer insert

8 Piece Set

Item #: WW0965900501

ZEBRA SCREWDRIVER WITH 1/4" SQUARE TIP - INCLUDES RATCHET ADAPTER



One-piece blade

- Blade: Round, bright chrome-plated
 - Tip: DIN 3120-A 6.3
 - With ratchet adapter
- Packing & Sold In: Each



Includes Ratchet Adapter!

Item #	(in.)			(in.)
		A (mm)	B/C (mm)	
WW0613430310	1/4"	110	106/35	4 3/8"

ZEBRA SCREWDRIVER WITH 1/4" SQUARE TIP



Blade: Round, bright chrome-plated

- Tip: DIN 3126-D 6.3
- Packing & Sold In: Each

Item #	(in.)			(in.)
		A (mm)	B/C (mm)	
WW0613430311	1/4"	110	106/35	4 3/8"

ZEBRA SCREWDRIVER WITH 1/4 INCH BIT CHUCK



Blade: Round with magnet

- Head: Bright nickel-plated
 - Tip: DIN 3126-D 6.3
- Packing & Sold In: Each

Item #	(in.)			(in.)
		A (mm)	B/C (mm)	
WW061343031	1/4"	100	106/35	4"

ZEBRA SCREWDRIVER WITH 1/4 INCH BIT CHUCK



Flexible shaft

- Blade: Round, bright chrome-plated
 - Tip: DIN 3120-A 6.3
- Packing & Sold In: Each

Item #	(in.)			(in.)
		A (mm)	B/C (mm)	
WW06134733	1/4"	150	106/35	6"

ZEBRA RATCHET MAGAZINE SCREWDRIVER (INCLUDES 12 BITS)

Item # **WW06136103**



Equipped with 12 bits

- Blade: Circular blade with magnet, bright chrome-plated
- Tip: DIN 3126-D 6.3
- 28 teeth, max. torque over 20 Nm.
- Advantage of the ratchet function is no need to reposition

- hand. This enables fast, efficient operation in any assembly situation. Bit magazine for max. 12 bits
- Extendible, rotating magazine lets you find the bit you need quickly.
- 1/4" bit with color coding system

Packing & Sold In: Each



Designation	Tip
Included Bits	
PH 1	
PH 2	
TX 10	
TX 15	
TX 20	
TX 25	
TX 30	
Allen 4 mm	
Allen 5 mm	
Allen 6 mm	
Slotted, 0.6 x 4.5 mm	
1/4"	



Magnetic blade mount for 1/4" bits



Max. 12 bits

Easy removal of the desired bit



Secure closing thanks to "snap lock"

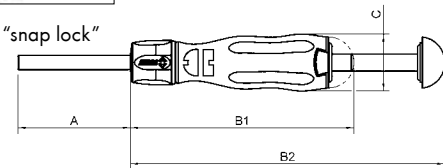

(in.)	A (mm)	B1/B2 (mm)	C (mm)
1/4"	80	147/207	37.5

ZEBRA MINI RATCHET SCREWDRIVER (INCLUDES 11 BITS)



10-piece bit strip + PH2 bit

- 2K handle
- Blade: Short bit holder blade with magnet, bright chrome-plated
- Tip: DIN 3126-D 6.3
- For high torque applications in tight spaces

Packing & Sold In: Each

Bits included (1 each):	
	1/4"
	5.5 mm
	4 mm, 5 mm
	PH 1, PH 2



Item #	(in.)				
		A (mm)	B (mm)	C (mm)	A2 (mm)
WW061363050	1/4"	26	70	38	20

ZEBRA T-HANDLE HEXAGON SOCKET WRENCH

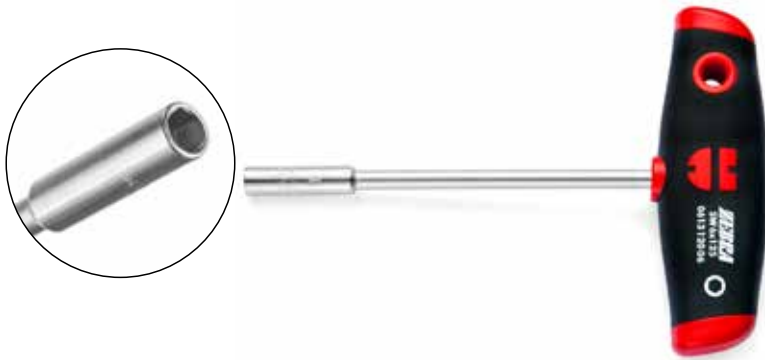

For hexagon head screws

- Blade: Round, chrome-plated
 - Tip: DIN 475/2
 - Inner bore for protruding threaded shafts
 - Standard: DIN 3125
- Packing & Sold In: Each

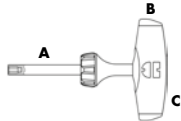
Item #	 (mm)				
		A (mm)	B/C (mm)	A (in.)	
WW061312010	10	125	35/104	5"	
WW061312013	13				
WW061312016	16		39/117		
WW061312017	17				
WW061312108	8	200	35/104	8"	
WW061312110	10	230		9 3/16"	
WW061312113	13				
WW061312208	8	300		35/104	12"
WW061312210	10				
WW061312213	13				

ZEBRA T-HANDLE SOCKET WRENCH SET (5 PIECES)

Item # **WW061391205** 5 piece set



- Blade: Circular, nickel-plated
 - Output: DIN 475/2
 - Inner bore for protruding threaded shafts
 - Standard: DIN 3125
- Packing & Sold In: Each

Includes:

Item #	 (mm)	Blade Length (mm)
Only available in set	6	125
WW061312007	7	
WW061312008	8	
WW061312010	10	
WW061312013	13	

ZEBRA T-HANDLE BALL HEAD TIP SCREWDRIVER WITH SIDE HEXAGON TIP

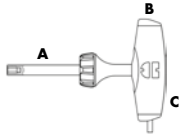
Item #	(mm)				Tip
		A (mm/in.)	B/C (mm)	Length of Side Hex Tip (mm)	
WW061313005	5	150/6"	35/105	17	Ball Head Tip
WW061313006	6				
WW061313008	8				
WW061313105	5	200/8"	39/117	22	
WW061313106	6				
WW061313108	8				
WW061313110	10				



Features:

- Integrated side tip
 - High-quality blade
 - One-piece blade
 - Multi-component handle comprising solid core and soft casing
 - Black point tip
- Packing & Sold In: Each

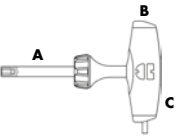

Item #	(mm)				Tip		
		A (mm/in.)	B/C (mm)	Length of Side Hex Tip (mm)			
WW0613132025	2.5	150/6"	27/82	13	Hex Head Tip		
WW061313203	3						
WW061313204	4		35/105	17			
WW061313205	5						
WW061313206	6						
WW061313208	8	200/8"	39/117	22			
WW061313303	3					27/82	13
WW061313304	4						
WW061313305	5					35/105	17
WW061313306	6						
WW061313308	8						
WW061313310	10						



ZEBRA T-HANDLE HEX BLADE SCREWDRIVER SET (6 PIECES)

Item # WW061391306 6 piece set



- 1 each of T-handle wrench with ball head hexagon socket, size 5 mm, 6 mm, 8 mm
 - 1 each of T-handle wrench with hexagon socket, size 2.5 mm, 3 mm, 4 mm
- Packing & Sold In: Each

Includes:

Item #	 Contents (mm)	Blade Length (mm)	Tip
WW0613132025	2.5	150	Hex Head Tip
WW061313203	3		
WW061313204	4		
WW061313005	5		Ball Head Tip
WW061313006	6		
WW061313008	8		



WRENCHES

ALLEN KEYS

RIVETERS

SCREWDRIVERS

T-HANDLES

BITS

RATCHETS

ZEBRA T-HANDLE TORX HEAD SCREWDRIVER WITH SIDE HEX TIP



Integrated side tip

- Effortless tightening and loosening of screw connections
- Particularly suitable for rusted and seized screw connections

High-quality blade

- Matte chrome-plated hexagon blade for optimal corrosion protection and long service life
- High-quality special steel ensures optimal balance of ductility and wear resistance

One-piece blade

- Resistant even to extremely high stresses

Multi-component handle comprising solid core and soft casing

- Highly slip-proof special black plastic ensures maximum torque transfer
- Solid core and soft casing ensure rigidity and a secure grip
- Ergonomically adapted handle for a comfortable grip and fatigue-free operation
- Integrated drilled hole for storage on tool rack

Black point tip

- Higher torque and a precise fit

Output: For TX socket

Packing & Sold In: Each

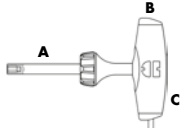
Item #	 (mm)			
		A (mm/in.)	B/C (mm)	Length of Side Hex Tip (mm)
WW061314009	TX 9	100/4"	27/82	13"
WW061314010	TX 10			
WW061314015	TX 15			
WW061314020	TX 20			
WW061314025	TX 25	200/8"	35/105	17"
WW061314027	TX 27			
WW061314030	TX 30			
WW061314040	TX 40			
WW061314045	TX 45			

ZEBRA T-HANDLE TORX SOCKET SCREWDRIVER SET (6 PIECES)

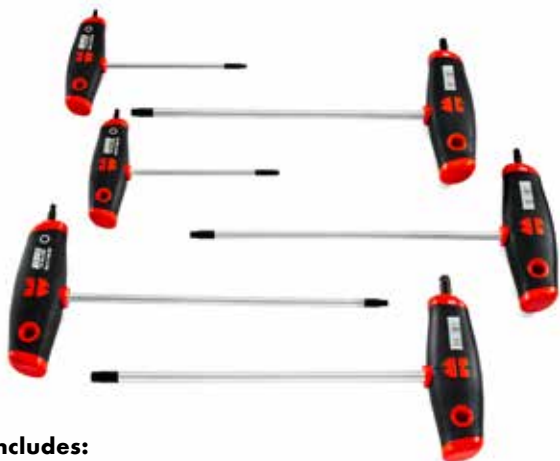

Item # WW061391406 6 piece set



For TX socket, with side output

Integrated side tip

- Effortless tightening and loosening of screw connections

High-quality blade

- Matte chrome-plated hexagon blade for optimal corrosion protection and long service life

Multi-component handle comprising solid core and soft casing

- Highly slip-proof special black plastic ensures maximum torque transfer
- Integrated drilled hole for storage on tool rack.

Contents: 6 pcs.

- 6 T-handle screwdrivers for TX socket (TX 10, 15, 20, 25, 30, 40)

Packing & Sold In: Each

Includes:

Item #		Blade Length (mm)
WW061314010	TX 10	100
WW061314015	TX 15	
WW061314020	TX 20	200
WW061314025	TX 25	
WW061314030	TX 30	
WW061314040	TX 40	

ZEBRA T-HANDLE, TORX SOCKET SET - IN SHEET STEEL RACK - 7 PIECES

Item # **WW06139147** 7 piece set

WRENCHES

ALLEN KEYS

RIVETERS

SCREWDRIVERS

T-HANDLES

BITS

RATCHETS



Includes:

Item #	⬠ (mm)	Blade Length (mm)
WW061314010	TX 10	100
WW061314015	TX 15	
WW061314020	TX 20	200
WW061314025	TX 25	
WW061314030	TX 30	
WW061314040	TX 40	
WW061314045	TX 45	



In sheet steel rack

Integrated side output

- Effortless tightening and loosening of screw connections
- Particularly suitable for rusted and seized screw connections

Multi-component handle comprising solid core and soft casing

- Ergonomically adapted handle for a comfortable grip and effortless work
- Integrated drilled hole for storage on tool rack

Black Point tip

- Higher torque and a precise fit

One-piece blade

- Resistant even to extremely high stresses

Contents: 7 pieces

- 1 each of T-handle screwdriver TX 10; TX 15; TX 20; TX 25; TX 30; TX 40; TX 45

Packing & Sold In: Each

ZEBRA T-HANDLE RATCHET SCREWDRIVER SET WITH 11 PIECE BITS

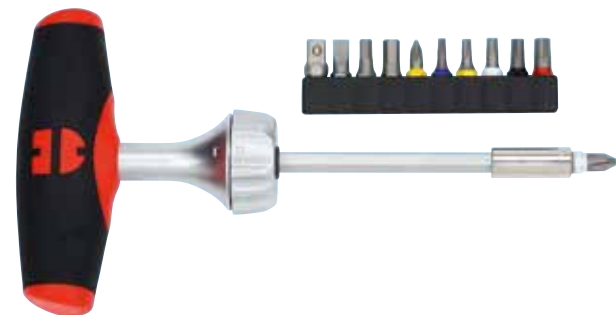

With 10-piece bit strip + PH2 bit

Robust ratchet function with 45 teeth

- Max. torque of up to 40 Nm
- 3-position adjustment wheel is adjustable with one hand
- Easy, one-handed change of direction while working

Packing & Sold In: Each

Bits included (1 each):	
	1/4"
	5.5 mm
	4 mm, 5 mm
	PH 1, PH 2



Ratchet function
Very rugged design, max. torque up to 40 Nm (29.5 lb-ft).

Item #	⬠ (in.)				
		A (mm)	B (mm)	C (mm)	A2 (mm)
WW061363040	1/4"	95	85	100	10

ZEBRA FLEXIBLE BIT HOLDER LENGTH 175MM - 1/4" DRIVE



Item #	Drive (in.)	Drive Type	Tip Size (in.)	Tip Type	Length (mm)
WW0613713	1/4"	Outer Hexagon	1/4"	Internal Hexagon Socket	175

RATCHET BIT ASSORTMENT - 38 PIECES



Bit set especially for automobiles and commercial vehicles, 38 pieces

- ZEBRA ratchet for 10 mm bits
- Additional ZEBRA adapter allows use of a 1/2" ratchet
- Supplied in a metal box with high quality interior foam compartment with clamping effect

Packing & Sold In: Each; Replacement bits sold in multiples of 5 each

Includes:

Item #	Destination	Drive	Length
WW071412100	ZEBRA Ratchet for 10mm bits		175mm
WW07151303	ZEBRA Adapter for 1/2" ratchet		37mm
WW061478820	TX 20 with hole		30mm
WW061478825	TX 25 with hole		
WW061478827	TX 27 with hole		
WW061478830	TX 30 with hole		
WW061478840	TX 40 with hole		
WW061478845	TX 45 with hole		
WW061478850	TX 50 with hole		
WW061478855	TX 55 with hole		
WW0614788120	TX 20		75mm
WW0614788125	TX 25		
WW0614788127	TX 27		
WW0614788130	TX 30		
WW0614788140	TX 40		
WW0614788145	TX 45		
WW0614788150	TX 50		
WW0614788155	TX 55		

Item #	Description
WW096512370	Ratchet Bit Set

Item #	Destination	Drive	Length
WW0614788240	TX 40		120 mm
WW0614788245	TX 45		
WW0614788250	TX 50		
WW0614788305	Hexagon socket M5		30 mm
WW0614788306	Hexagon socket M6		
WW0614788307	Hexagon socket M7		
WW0614788308	Hexagon socket M8		
WW0614788310	Hexagon socket M10		
WW0614788312	Hexagon socket M12		
Only Available in Set	Triple Square M5		30 mm
WW0614788406	Triple Square M6		
WW0614788408	Triple Square M8		
WW0614788410	Triple Square M10		
WW0614788412	Triple Square M12		75 mm
Only Available in Set	Triple Square M6		
WW0614788508	Triple Square M8		
WW0614788510	Triple Square M10		
Only Available in Set	Triple Square M12		
WW0614788902	PH 2		30 mm
WW0614788903	PH 3		

- 1 Ratchet with short 10 mm bit
- 2 1/2" ratchet with adapter

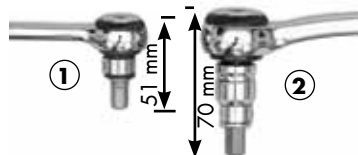

1/4 INCH PHILLIPS BIT (HEX QUICK CHANGE)

Packing & Sold In: Each



Item #	Designation	Phillips-Head System	Tip	Drive	Length (mm)
WW0614100201	PH 2	MSVM 2 - Magazine attachment - Makita		1/4"	152
WW0614100111		MSVW 1 - Magazine attachment - Wurth / Bosch			155
WW0614100211		MSVW 2 - Magazine attachment - Wurth / Bosch			168
WW0614100212		S50-TB - Magazine screw attachment - Wurth/Kress/Eibenstock			176.5

POWERDRIV HEX BIT - 3MM, 1/4 INCH DRIVE, 25MM LENGTH



POWERDRIV® bits allow force to be distributed across the curved surfaces on each side of the hexagon.

Packing & Sold In: Each; Multiples of 5

Item #	Tip size (mm)	Tip type	Drive	Length (mm)
WW061417693	3		1/4"	25
WW061417694	4			
WW061417695	5			
WW061417696	6			

1/4 INCH MAGNETIC BIT HOLDER (HEX QUICK CHANGE) - 75MM LENGTH



Quick-change chuck and permanent magnet

- Super-fast tool change: pushing the clamping collar forward releases the latch mechanism

Packing & Sold In: Each

Item #	Designation	Tip	Drive	Length (mm)
WW614176708	Multi-purpose holder	1/4"	1/4"	75

1/4 INCH NON-MAGNETIC BIT HOLDER (HEX QUICK CHANGE) - 51MM LENGTH



Quick-change chuck

- Quick-change chuck
- Non-magnetic holder for screwing in metallic environments
- Super-fast tool change: pushing the clamping collar forward releases the latch mechanism

Packing & Sold In: Each

Item #	Designation	Tip	Drive	Length (mm)
WW614176711	Multi-purpose holder	1/4"	1/4"	51

ZEBRA UNIVERSAL BIT ASSORTMENT (105 PIECES)



Item # **WW0614250300** 105 piece set



Comprehensive 1/4" bit assortment with the most common standard and security bits in short and long versions

- A majority of the bits are for security screws. Used wherever unauthorized loosening is to be prevented
- Includes two bit adapters and one screw hook
- The solution for virtually all screw types
- In sturdy metal box with foam insert

Areas of Application:

Public facilities, motor vehicle and motorcycle sector, plumbing applications, construction industry, electrical, electronics and machine sector

SOCKETS
PLIERS / CUTTERS

Designation	Tip	Length	Qty.
AW [®]	10	25 mm	1
AW [®]	20		2
AW [®]	25		1
AW [®]	30		
AW [®]	40		
Slotted	0.6 x 4.5 mm		
Slotted	0.8 x 5.5 mm		
Slotted	1.2 x 6.5 mm		
Slotted	1.2 x 8 mm		
PH	0		2
PH	1		
PH	2		
PH	3		1
PZ	0		
PZ	1		
PZ	2		2
PZ	3		
PZ	3		
TX	8	1	
TX	10		
TX	15		
TX	20		
TX	25		
TX	27		
TX	30		
TX	40		
TX	45		
Allen Head	2 mm		25 mm
Allen Head	2.5 mm		
Allen Head	3 mm		
Allen Head	4 mm		
Allen Head	5 mm		
Allen Head	6 mm		
Allen Head	1/4"		
Allen Head	7 mm		
TX with hole	8		

Designation	Tip	Length	Qty.	
TX with hole	10	25 mm	1	
TX with hole	20			
TX with hole	25			
TX with hole	27			
TX with hole	30			
TX with hole	40			
TX with hole	45			
Claw Wrench	4/6/8/10			4
Three-wing	1/2/3/4			
	6/8/10			3
XZN	M4/5/6/8	4		
Allen head in inches	1/8", 9/64" 5/32",			
	M5/6/7/8			
Allen head with hole	2/2.5/3/4 mm			
Allen head with hole	5/6/7 mm	3		
Square	1/2/3/4	4		
Clutch	3/32", 1/8", 5/32"	3		

ZEBRA RATCHET WITH ROTARY DISC REVERSE



Rotary disc reverse

Fine tooth rotary disc with 72 teeth; 5° angle of rotation

- Compact, narrow head
 - Simple changeover from clockwise to counterclockwise rotation
 - Chamfered square – easier removal of socket wrench inserts
 - Offset ratchet body for more hand freedom
- Packing & Sold In: Each

Item #	Description	Tip Size	Length (mm)
WW07120140	Ratchet with rotary disc reverse	1/4"	138
WW07120380		3/8"	175
WW07120120		1/2"	250

ZEBRA 1/4 INCH BALL-HEAD 3-IN-1 RATCHET



Multi-functional spherical ratchet with adjustable handle

Features:

- Drive: 6.3 – 1/4"
 - Standard: DIN 3122, ISO 3315
 - Head: 72 teeth, angle of rotation: 5°, joint can be rotated 270°
 - Handle: Two-component handle, straight or adjustable 90° as T-handle
- Packing & Sold In: Each

Item #	Length (mm)	Ratchet head height (mm)	Ratchet diameter (mm)
WW071201405	145	26.5	20



3 in 1!

Can be used like a conventional ratchet, as a screwdriver or a T-handle!



ZEBRA 1/4 INCH LEVER REVERSIBLE RATCHET, DUST PROTECTED

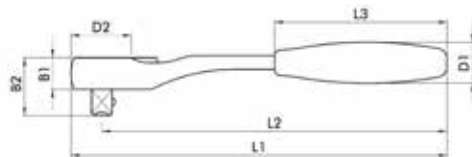

Dust-protected ratchet for a long service life even under difficult working conditions

- Standard: DIN 3122, ISO 3315
- Reversing lever for clockwise and counterclockwise rotation
- Geometry: Ratchet body with depressed center for more freedom of movement
- Material: Chrome-vanadium steel
- Grip Handle Material: 2-component plastic
- With 72 teeth, 5 ° angle of rotation

Packing & Sold In: Each

Item #	Tip Size	L1 (mm)	L2 (mm)	L3 (mm)	B1 (mm)	B2 (mm)	D1 (mm)	D2 (mm)
WW071201403	1/4"	136	125	61	13	22	16	21
WW071203803	3/8"	177	160	79	16	29	21	29
WW071201203	1/2"	253	240	115	19	36	26	38

ZEBRA 10 MM RATCHET TOOL

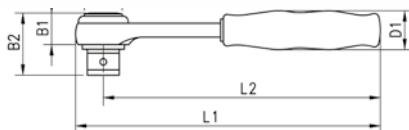

Features:

- Head: 72 teeth, swivel angle 5°, round, compact head
 - Shaft: Chrome-plated, high-grip 2-component handle
- Packing & Sold In: Each

Item #	Destination	Drive	L1 mm	L2 mm	B1 mm	B2 mm	D1 mm	D2 mm	Length
WW071412100	Ratchet for 10mm bits		175	160	19	33	26	20	175mm
WW07151303	Adapter for 1/2" ratchet								37mm

ZEBRA 1/2 INCH JOINTED HANDLE



Features:

- Standard: DIN 3122, ISO 3315
 - Joint: Rotatable through 180°, head can be used in any desired position
 - Flexible operation even in obstructed areas
 - Powerful breaking and tightening ability
 - Chrome-plated
- Packing & Sold In: Each

Item #	Length (mm)	Tip size (in.)	Handle diameter (mm)	Width of head (mm)
WW0712130102	490	1/2"	35	20

ZEBRA 1/4 INCH SOCKET BITS

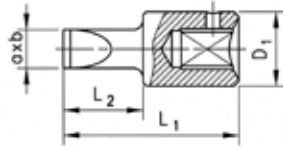

Socket Wrench, Slotted

- Surface: Chrome-plated, polished/matte
 - Drive: 1/4" square socket, ball catch groove
 - Tip: DIN 5264, slotted
- Packing & Sold In: Each

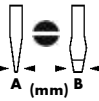
Item #	 A (mm) B	L1 (mm)	L2 (mm)	D1 (mm)
WW071511735	0.6 x 3.5	32	12	12
WW071511755	1.0 x 5.5			
WW071511765	1.2 x 6.5			
WW071511780	1.2 x 8.0			

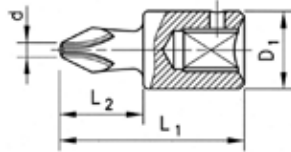

Socket Wrench, Phillips

- Surface: Chrome-plated, polished/matte
 - Drive: 1/4" square socket, ball catch groove
 - Tip: ISO 8764-PH
- Packing & Sold In: Each

Item #	 (mm)	L1 (mm)	L2 (mm)	D1 (mm)
WW071511801	PH 1	32	12	12
WW071511802	PH 2			
WW071511803	PH 3			

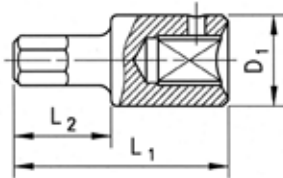

Socket Wrench, Hexagon

- Surface: Chrome-plated, polished/matte
 - Drive: 1/4" square drive, ball catch groove
 - Output: For hexagon socket, DIN 7422
- Packing & Sold In: Each

Item #	 (mm)	L1 (mm)	L2 (mm)	D1 (mm)
WW071511503	3	32	12	12
WW071511504	4			
WW071511505	5			
WW071511506	6			
WW071511507	7			
WW071511508	8			

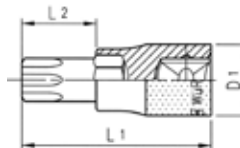

Socket Wrench, Torx

- Surface: Chrome-plated
 - Drive: 1/4" square socket, ball catch groove
 - Tip: For TX screws
- Packing & Sold In: Each

Item #	(mm)	L1 (mm)	L2 (mm)	D2 (mm)
WW071511310	2.72	10	32	12
WW071511315	3.26	15		
WW071511320	3.84	20		
WW071511325	4.40	25		
WW071511327	4.96	27		
WW071511330	5.49	30		
WW071511340	6.60	40		

WRENCHES

ALLEN KEYS

RIVETERS

SCREWDRIVERS

T-HANDLES

BITS

RATCHETS

ZEBRA 1/4 INCH EXTENSION

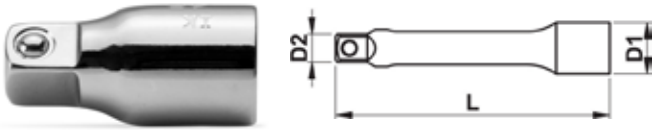

- Surface: Chrome-plated, polished
 - Drive: 1/4" square drive, ball catch groove
- Packing & Sold In: Each

Item #	Length (mm)	D1 (mm)	D2 (mm)
WW0713118101	25	12	8.3
WW0713118102	53		
WW0713118104	101		
WW0713118106	152		
WW0713118110	250		

ZEBRA 1/2 INCH ANGLED EXTENSION



Item # **WW0712138100**

For working in hard-to-reach places

- Standard: DIN 3123, ISO 3316
- Surface: Chrome-plated
- Drive: 1/2" square socket, ball catch groove
- Tip: 1/2" square head
- Length: 50 mm
- Angular movement of up to 8"
- Tip: 1/4" square head

Packing & Sold In: Each

ZEBRA 3/8 INCH EXTENSION



Item # **WW0713128105**

- Standard: DIN 3123, ISO 3316
- Surface: Chrome-plated
- Drive: 3/8" square socket, ball catch groove
- Tip: 3/8" square head
- Length: 125 mm

ZEBRA 1/2 INCH EXTENSION



- Standard: DIN 3123, ISO 3316
- Surface: Chrome-plated
- Drive: 1/2" square socket, ball catch groove
- Tip: 1/2" square head

Packing & Sold In: Each

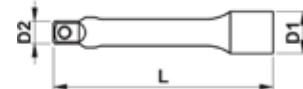

Item #	Length (mm)	D1 (mm)	D2 (mm)
WW0712138102	53	23	15
WW0712138103	75		
WW0712138105	125		
WW0712138110	250		17
WW0712138118	457		

ZEBRA 1/2 INCH POWERDRIV (12-POINT) SOCKET

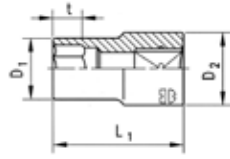

Metric, short

- Standard: DIN 3124, ISO 2725
- Surface: Chrome-plated, ground/matte
- Drive: 1/2" square socket, ball catch groove
- Tip: POWERDRIV®

Packing & Sold In: Each

Item #	(mm)	L1 (mm)	D1 (mm)	D2 (mm)	t (mm)
WW0712133108	8	36	12.9	21.9	7
WW0712133109	9		14		8
WW0712133110	10		15.4		10
WW0712133111	11		16.6		
WW0712133112	12		17.9		11
WW0712133113	13		19.1		
WW0712133114	14		20.4		
WW0712133115	15		21		
WW0712133116	16		22.5		16
WW0712133117	17		24		
WW0712133118	18	25.4	23.5		
WW0712133119	19	26.5	24.7	19	
WW0712133120	20	27.9	25.5		
WW0712133121	21	38	28.5	26	24
WW0712133122	22		29.9	26.5	
WW0712133123	23		31.2	27.7	
WW0712133124	24		32	29	
WW0712133126	26		35	31.5	
WW0712133127	27		36	32.2	
WW0712133128	28	44	37.7	33.5	
WW0712133130	30		40	36	
WW0712133132	32		42	38.1	
WW0712133134	34	47	45.5	40	25
WW0712133136	36	50	48	42	28.5

ZEBRA 1/2 INCH SOCKET BITS - TORX

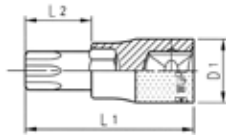

Torx, short

- Design: Short
- Surface: Chrome-plated
- Drive: 1/2" square socket, ball catch groove
- Tip: For TX screws

Packing & Sold In: Each

Item #	(mm)	L1 (mm)	L2 (mm)	D1 (mm)
WW071513320	20	60	20	22.5
WW071513325	25			
WW071513327	27			
WW071513330	30			
WW071513340	40			
WW071513345	45			
WW071513350	50			
WW071513355	55			
WW071513360	60			
WW071513370	70			
WW071513380	80	28		
WW0715133100	100	80	42	26

ZEBRA 1/2 INCH POWERDRIV (HEXAGON) SOCKET

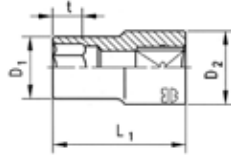

Metric, long

- Surface: Chrome-plated, polished/matte
 - Drive: 1/2" square socket, ball catch groove
 - Tip: **POWERDRIV®** (Hexagon)
- Packing & Sold In: Each

Item #	⬡ (mm)	L1 (mm)	D1 (mm)	D2 (mm)	t (mm)
WW0712132310	10	77	15.4	21.8	25.0
WW0712132311	11				
WW0712132312	12				
WW0712132313	13				
WW0712132314	14				
WW0712132315	15		21.6	21.6	
WW0712132316	16		22.6	22.6	
WW0712132317	17		24.1	24.1	
WW0712132318	18		25.4	25.4	
WW0712132319	19		26.5	26.5	
WW0712132320	20		27.8	27.8	
WW0712132321	21		28.2	28.2	
WW0712132322	22		29.7	29.7	
WW0712132323	23		31.2	27.0	
WW0712132324	24		31.7		
WW0712132326	26		35.4	33.0	
WW0712132327	27	35.7			
WW0712132328	28	37.6	33		
WW0712132330	30	39.8			
WW0712132332	32	41.9	34		

ZEBRA 1/2 INCH TORX SOCKET BITS, LONG

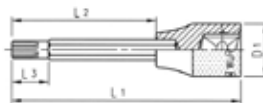

Torx, long

- Surface: Chrome-plated
 - Drive: 1/2" square socket, ball catch groove
 - Tip: For TX screws
- Packing & Sold In: Each

Item #	⬡ (mm)	L1 (mm)	L2 (mm)	L3 (mm)	D1 (mm)
WW071513430	30	120	80	12.5	22.5
WW071513440	40				
WW071513445	45				
WW071513450	50	140	100	-	25
WW071513455	55				
WW071513460	60				
WW071513470	70				

ZEBRA 1/2 INCH SOCKET BITS

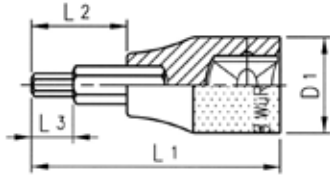

Hexagon

- Surface: Chrome-plated, polished/matte
- Drive: 1/2" square socket, all catch groove
- DIN 7422

Packing & Sold In: Each

Item #	(mm)		L1 (mm)	L2 (mm)	L3 (mm)	D1 (mm)	
WW0715137040	4		60	20	6	22.5	
WW0715137051	5				7.5		
WW0715137060	6				9		
WW0715137062	6		140	100	-		25
WW071513707	7		60	20			
WW0715137080	8		140	100			
WW0715137082	8						
WW0715137100	10		60	20			
WW0715137102	10		140	100			
WW0715137120	12		60	20			
WW0715137122	12		140	100			
WW071513714	14		60	20			
WW071513717	17	28					

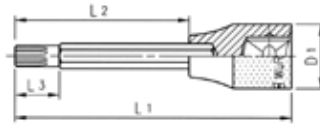

12-Point, Short

- Surface: Chrome-plated
- Drive: 1/2" square socket, ball catch groove

Packing & Sold In: Each

Item #	(mm)		L1 (mm)	L2 (mm)	L3 (mm)	D1 (mm)	
WW071513805	5		60	20	4	22.5	
WW071513806	6				5		
WW071513808	8				100		60
WW0715138081	8						
WW071513810	10						
WW0715138101	10						
WW0715138121	12		60	20	-		25
WW071513814	14						
WW0715138160	16						

ZEBRA 1/2 INCH HEXAGON SOCKET BIT, SHORT

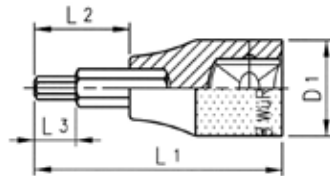

Standard

- Surface: Chrome-plated, polished/matte
- Drive: 1/2" square socket, ball catch groove

Packing & Sold In: Each

Item #	(in.)		L1 (mm)	L2 (mm)	L3 (mm)	D1 (mm)
WW071513751	7/32		60	20	8.34	22.5
WW071513752	1/4				9.53	
WW071513754	3/8				-	
WW071513756	1/2					

ZEBRA STEP-DOWN/UP SOCKETS

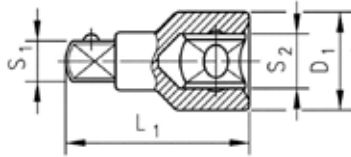

- Standard: DIN 3123, ISO 3316
- Surface: Chrome-plated, polished
- Material: Steel

Packing & Sold In: Each

Item #	S2 (in)	S1 (in)	L1 (mm)	D1 (mm)
WW0713118401	1/4"	3/8"	24	12.5
WW0713128401	3/8"	1/4"	27	17
WW0713128402		1/2"	36	20
WW0712138401	1/2"	3/8"	38	23
WW0712138402		3/4"	44	25
WW071514108	3/4"	1/2"	53.5	34

ZEBRA UNIVERSAL JOINTS



1/4"



3/8"



1/2"

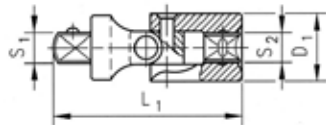

- Surface: Chrome-plated, polished
- Remains in specified position

Packing & Sold In: Each

Item #	S2 (in)	S1 (in)	L1 (mm)	D1 (mm)
WW0713118301	1/4"	1/4"	33	14
WW0713128301	3/8"	3/8"	55	17.5
WW0712138301	1/2"	1/2"	70	25



1/2 INCH IMPACT SOCKETS

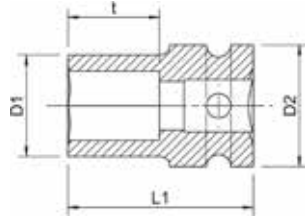

Metric, short

- For use with electric or pneumatic screwdrivers and impact tools
- Standard: DIN 3129, DIN 3121/ISO 1174
- Design: Forged, burnished
- Drive: Square socket 1/2"
- Tip: Hexagon

Packing & Sold In: Each

Item #	Hex (mm)	L1 (mm)	D1 (mm)	D2 (mm)	t (mm)
WW07141302	9.5	38	17	25	12
WW07141303	10		20		10
WW07141304	12		21		12
WW07141305	13		22.5	30	13.5
WW07141306	14		23		12
WW07141307	15		25		12.5
WW071413071	16		26		13.5
WW07141308	17		27.3		15
WW071413081	18		28.5		14
WW07141309	19		30		14.5
WW071413091	21	32	17		
WW07141310	22	34	20		
WW07141311	24	38	19		
WW07141312	27	42	20		
WW07141330	30	44	42	30	19
WW07141332	32		44		20
WW07141334	34		46		21.5
WW07141336	36	48	49		18.5

Metric, long

- For use with electric or pneumatic screwdrivers and impact tools
- Standard: DIN 3129, DIN 3121/ISO 1174
- Design: Forged, burnished
- Drive: Square socket 1/2"
- Tip: Hexagon

Packing & Sold In: Each

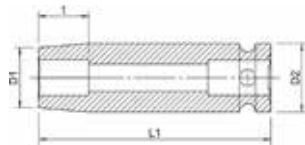

Item #	Hex (mm)	L1 (mm)	D1 (mm)	D2 (mm)	t (mm)
WW07141313	13	78	20.5	25	17
WW071413131	16		24		
WW07141314	17		26		
WW071413142	18		27.3	30	23
WW07141315	19		28		
WW071413151	21		30		
WW07141316	22		32		30
WW07141317	24		34		
WW07141318	27		38		

1/2 INCH IMPACT EXTENSIONS

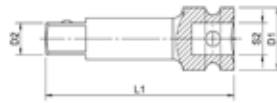

- For use with electric or pneumatic screwdrivers and impact tools
- Standard: DIN 3121/ISO 1174
- Design: Forged, burnished
- Drive: Square socket 1/2"
- Tip: External square drive 1/2", with ball lock

Packing & Sold In: Each

Item #	S2 (in)	L1 (mm)	D1 (mm)	D2 (in)
WW07141322	1/2"	75	25	1/2"
WW07141323	1/2"	150		1/2"

IMPACT STEP-UP SOCKET - 1/2 INCH TO 3/4 INCH

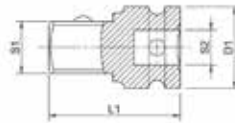

- For all electrical or compressed air-driven screwdrivers and impact tools
- Drop-forged steel guarantees high breaking and wear resistance
- Standard: DIN 3121/ISO 1174
- Design: Forged, burnished
- Drive: 1/2" square socket
- Tip: 3/4" square head

Packing & Sold In: Each

Item #	S2 (in)	S1 (in)	L1 (mm)	D1 (mm)
WW07141328	1/2"	3/4"	48	30

1/2 INCH IMPACT UNIVERSAL JOINT

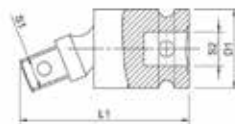

- For use with electric or pneumatic screwdrivers and impact tools
- Standard: DIN 3121/ISO 1174
- Design: Forged, burnished
- Drive: square socket 1/2"
- Tip: External square drive 1/2", with ball lock

Packing & Sold In: Each

Item #	S2 (in)	S1 (in)	L1 (mm)	D1 (mm)
WW0714138351	1/2"	1/2"	63	30

ZEBRA 1/4 INCH MULTI-SOCKETS



12-Point

- Surface: Chrome-plated, polished
- Drive: 1/4" square socket
- Tip: 12-point

Packing & Sold In: Each

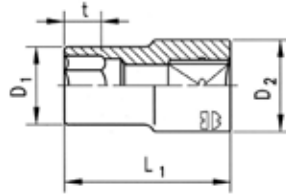

Item #	Multi-profile (mm)	Possible Uses				L1 (mm)	D1 (mm)	D2 (mm)	t (mm)
		Hexagon/bi-hexagon (mm)	Hexagon (in.)	TX Head TX	Square (mm)				
WW071311304	4	Size 4	5/32"	E 5	-	22	6.8	11.9	5
WW071311305	5	Size 5	-	-	Size 4		8.1		
WW0713113055	5.5	Size 5.5	7/32"	-	Size 4.5		8.7		6
WW071311306	6	Size 6	-	E 8	Size 5		9.3		
WW071311307	7	Size 7	9/32"	-	-		10.8		7
WW071311308	8	Size 8	5/16"	E 10	-		11.9		
WW071311309	9	Size 9	11/32"	-	-		13.4	13.4	
WW071311310	10	Size 10	3/8"	E 12	Size 8		14.5	14.5	10
WW071311311	11	Size 11	7/16"	E 14	Size 9		15.9	15.9	
WW071311312	12	Size 12	15/32"	E 16	Size 10		16.9	16.9	
WW071311313	13	Size 13	1/2"	-	-		18.0	18.0	11
WW071311314	14	Size 14	9/16"	E 18	-		19.6	19.6	

WRENCHES
ALLEN KEYS
RIVETERS
SCREWDRIVERS
T-HANDLES
BITS
RATCHETS

ZEBRA 1/4 INCH MULTI-SOCKET ASSORTMENT (32 PIECES)



Item # **WW096511032** 32 piece set

The multiple profile is suitable for the five most common screw heads (hexagonal metric, square metric, bi-hex metric, hexagon inch, TX head)

- Supplied in a metal box with high-quality foam insert compartment with clamping effect
- 12 sockets
- 14 1/4" bits

Packing & Sold In: Each

Includes:

Item #	Description	Drive	Length
Only available in set	Reversing ratchet		138 mm
WW0713118104	Extension		100 mm
WW0713118106	Extension		150 mm
WW0713118301	Universal Joint		33 mm
WW0613430311	Screwdriver handle		216 mm
WW07151101	Adapter with quick change chuck		30 mm
WW071311304 Thru WW071311314	12 multi-use sockets, one each sizes 4-14	 	22 mm
WW614176461	Bit PH 2		25 mm
WW061417693	Bit hex, socket size 3		
WW061417694	Bit hex, socket size 4		
WW061417696	Bit hex, socket size 6		
WW06143110	TX 10		
Only available in set	TX 15		
WW06143120	TX 20		
WW06143125	TX 25		
WW06143127	TX 27		
WW06143130	TX 30		
WW06143140	TX 40		
			Sold in multiple of 5 each 25 mm



Hexagonal metric



Bi-hexagonal metric



Hexagon inch



Square metric



External Torx



ZEBRA 3/8 INCH MULTI-SOCKETS

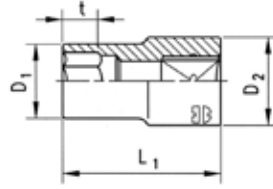

12-Point

- Surface: chrome-plated, polished
- Drive: 3/8" square socket
- Tip: 12-Point

Packing & Sold In: Each

Item #	Multi-profile (mm)	Possible Uses				L1 (mm)	D1 (mm)	D2 (mm)	t (mm)
		6-sd./12-sd. (mm)	6-sided (in.)	Outer TX TX	4-sided (mm)				
WW071312306	6	6 mm	-	E8	5 mm	25.5	9.3	17	7
WW0713123063	6.3	6.3 mm	1/4"	-	-		9.9		
WW071312307	7	7 mm	9/32"	-	-		10.9		
WW071312308	8	8 mm	5/16"	E10	-		11.8		
WW071312309	9	9 mm	11/32"	-	-		13.4		
WW071312310	10	10 mm	3/8"	E12	8 mm		14.6		
WW071312311	11	11 mm	7/16"	E14	9 mm		15.9		
WW071312312	12	12 mm	15/32"	E16	10 mm		17		
WW071312313	13	13 mm	1/2"	-	-		18.4		
WW071312314	14	14 mm	9/16"	E18	-		19.6		18
WW071312315	15	15 mm	19/32"	-	12 mm	20.9	19		
WW071312316	16	16 mm	5/8"	E20	13 mm	22	20		
WW071312317	17	17 mm	-	-	14 mm	23.4	21		
WW071312318	18	18 mm	-	E22	-	24.5	21.5		
WW071312319	19	19 mm	3/4"	E24	-	25.6	22.5		
WW071312320	20	20 mm	25/32"	-	16 mm	29	26.8	23.5	14
WW071312321	21	21 mm	13/16"	E26	17 mm		27.9	24.5	
WW071312322	22	22 mm	7/8"	E28	18 mm		29.6	26	

ZEBRA 3/8 INCH MULTI-SOCKET ASSORTMENT (22 PIECES)



Item # WW096512022 22 piece set

Newly developed multi-purpose profile fitting the 5 most common screw heads

- Hexagon metric, square metric, bi-hexagon metric, hexagon inch and external Torx
- Geometry: Short
- Supplied in a metal box with high-quality foam insert compartment
- High-quality multi-use socket bits guarantee a long service life
- Chrome-plated and polished
- Bit: 12-sided, multi-profile



ZEBRA STEP-UP AND STEP-DOWN SOCKET ASSORTMENT (8 PIECES)



Item # **WW09651280** 8 piece set

Combined adapter assortment with most common socket wrench and bit adapters

Socket Wrench Adapters (1 each)
 3/4" - 1/2", 1/2" - 3/4", 1/2" - 3/8",
 3/8" - 1/4", 1/4" - 3/8", 3/8" - 1/2"

Bit Adapters
 1/4" - 1/4", 3/8" - 5/16"

SOCKETS

PLIERS / CUTTERS

ZEBRA 1/2 INCH TORX, MULTI-POINT, AND ALLEN SOCKET ASSORTMENT (31 PIECES)



Item # **WW096513310** 31 piece set

Complete 1/2" assortment with short and long Allen, inner TX and multi-point sockets. Contents especially matched to automotive and cargo applications

- Metal box 350 x 260 x 55 mm (13-3/4" x 10-1/4" x 2-3/16")
- 8 TX socket wrenches, short version TX 25, 27, 30, 40, 45, 50, 55, 60
- 4 TX socket wrenches, long version TX 30, 40, 50, 60
- 4 Multi-point socket wrenches, short version M 5, 6, 8, 10
- 3 Multi-point socket wrenches, long version M 8, 10, 12
- 8 Allen socket wrenches, short version 5, 6, 7, 8, 10, 12, 14, 17 mm
- 4 Allen socket wrenches, long version 6, 8, 10, 12 mm



ZEBRA 1/2 INCH MULTI-SOCKETS

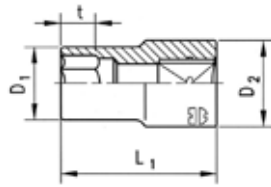

12-Point, Multi-profile for the five most common screw head drives

- Surface: Chrome-plated, polished
- Drive: 1/2" square socket
- Tip: 12-point, multi-profile

Packing & Sold In: Each

Item #	Multi-profile (mm)	Possible Uses				L1 (mm)	D1 (mm)	D2 (mm)	t (mm)	
		6-pt./12-pt. (mm)	6-pt. (in.)	Outer TX TX	4-pt. (mm)					
WW071213410	10	10	3/8"	E 12	8	36	15.5	23.0	9	
WW071213411	11	11	7/16"	E 14	9		16.7		10	
WW071213412	12	12	15/32"	E 16	10		18.0		11	
WW071213413	13	13	1/2"	-	-		19.2			
WW071213414	14	14	9/16"	E 18	-		20.5		13	
WW071213415	15	15	19/32"	-	12		21.7			
WW071213416	16	16	5/8"	E 20	13		23.0			
WW071213417	17	17	-	-	14		24.2		23.2	14
WW071213418	18	18	-	E 22	-		25.5		23.5	
WW071213419	19	19	3/4"	E 24	-		26.7		24.7	
WW071213420	20	20	25/32"	-	16	28.0	25.5			
WW071213421	21	21	13/16"	E 26	17	38	29.2	26.0	16	
WW071213422	22	22	7/8"	E 28	18		30.5	26.5		
WW071213424	24	24	15/16"	E 30	19		33.0	29.0	18	
WW071213426	26	26	-	E 32	21		35.5	31.5		
WW071213427	27	27	1 1/16"	E 34	22	44	36.7	32.2	20	
WW071213428	28	28	1 1/8"	E 36	23		38.0	33.5		
WW071213430	30	30	1 3/16"	E 38	24		40.5	36.0	22	
WW071213432	32	32	1 1/4"	E 40	26		43.0	38.1	24	

ZEBRA 1/2 INCH STANDARD HEXAGON SOCKET ASSORTMENT (21 PIECES)



Item # WW09651321 21 piece set

1 ratchet

1 125mm extension

1 250mm extension

1 universal joint

17 Socket Wrench Inserts Sizes

- 3/8", 7/16", 1/2", 9/16", 19/32", 5/8",
1 1/16", 3/4", 25/32", 13/16", 7/8",
15/16", 1-1/16", 1-1/8", 1-3/16", 1-1/4"

ZEBRA 1/2 INCH MULTI-SOCKET ASSORTMENT (23 PIECES)



Item # **WW096513023** 23 piece set

- Supplied in a metal box and a high-quality foam insert to hold each piece in place
- Box: 405 x 160 x 50 mm (approx.: 16" x 6-5/16" x 2")



Item #	Designation	Tip	Length
WW07120120	Ratchet		250 mm
WW0712138105	Extension Bar		125 mm
WW0712138110	Extension Bar		250 mm
WW0712138301	Universal Joint		70 mm

Designation	Tip	Length	Item #
19 multi-sockets, 1 ea., 10-32 mm		36 - 44 mm	See table below for details

1/2" Universal Joint

- Standard: DIN 3123, ISO 3316
- Finish: Chrome-plated
- Input drive: 1/2", ball groove
- Output drive: 1/2"
- Joint: Spring-loaded, stays in set position

1/2" Extension Bars

- Standard: DIN 3123, ISO 3316
- Finish: chrome-plated
- Input drive: 1/2" ball groove
- Output drive: 1/2"

1/2" High-Performance Ratchet

- Easy handling and maximum service life
- Drive: 12.5mm / 1/2"
- Standard, DIN 3122, ISO 3315
- Head: Fine-toothed, 72 teeth, 5° rotating angle
- Chrome-plated with anti-slip 2-component handle resistant to general workplace oils and cleaners
- Top quality, tested by German TÜV SÜD product service
- Handy directional switch for easy switching, even with oily fingers; can be operated with one hand
- Chamfer on square enables easier pull-off as better gripping is possible
- Offset ratchet body enables more clearance for gripping with screw connections

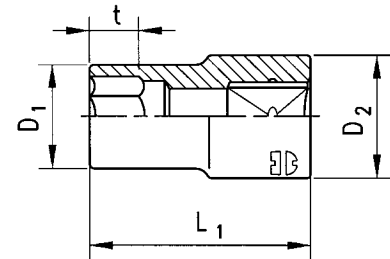

Includes:

Item #	Multi-	Possible uses						Note: This is a metric set. Standard sizes are only approximate equivalencies and may not work in all applications!				
		6/12 sided/12		6 sided								
								L1	D1	D2	t	
		in mm	in mm	bolt sz	head sz	in TX	in mm	in mm	in mm	in mm		
WW071213410		10	10	1/4"	3/8"	E12	8 mm	36	15.5	23	9	
WW071213411		11	11	1/4"	7/16"	E14	9 mm		16.7		10	
WW071213412		12	12	-	15/32"	E16	10 mm		18		11	
WW071213413		13	13	5/16"	1/2"	-	-		19.2		13	
WW071213414		14	14	3/8"	9/16"	E18	-		20.5			
WW071213415		15	15	-	19/32"	-	12 mm		21.7			
WW071213416		16	16	7/16"	5/8"	E20	13 mm		23			
WW071213417		17	17	-	-	-	14 mm		24.2		23.2	
WW071213418		18	18	-	-	E22	-		25.5		23.5	
WW071213419		19	19	1/2"	"	E24	-		26.7		24.7	
WW071213420		20	20	-	25/32"	-	16 mm		28		25.5	
WW071213421		21	21	9/16"	13/16"	E26	17 mm		29.2		26	
WW071213422		22	22	-	7/8"	E28	18 mm		30.5		26.5	
WW071213424		24	24	5/8"	15/16"	E30	19 mm		33		29	
WW071213426		26	26	-	-	E32	21 mm		35.5		31.5	
WW071213427		27	27	-	1-1/16"	E34	22 mm		36.7		32.2	
WW071213428		28	28	3/4"	1-1/8"	E36	23 mm		38		33.5	
WW071213430		30	30	-	1-3/16"	E38	24 mm	40.5	36			
WW071213432		32	32	-	-	E40	26 mm	43	38.1			



MULTI-PROFILE



Suitable for the five most common screw head drives:

- Hexagon metric
- Square metric
- Bi-hexagon metric
- Hexagon standard
- TX head

ZEBRA PASS-THROUGH REVERSIBLE RATCHET ASSORTMENT (14 PIECES)

WRENCHES

ALLEN KEYS

RIVETERS

SCREWDRIVERS

T-HANDLES

BITS

RATCHETS



Item # WW07131300 14 piece set

- Low-profile allows for access to narrow spaces
- Pass-through feature makes this set ideal for fastening hardware to long bolts and threaded rods
- Included socket adapters (1/4" & 3/8") can be used with any standard wrench
- Includes high-quality metal box for storage and transportation

Sockets

Bit: Hexagon, metric, POWERDRIV®
Model: Chrome-plated, polished

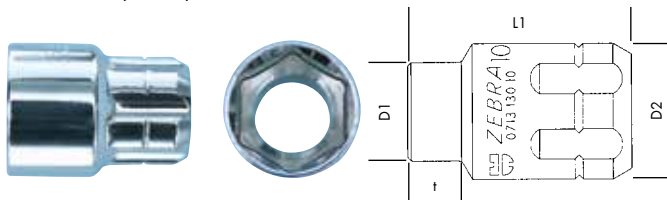

Includes:

Item #	Hexagon	L1 mm	t mm	D1 mm	D2 mm
	in mm				
WW071313010	10	32	7	14.7	19.5
WW071313011	11			15.4	
WW071313012	12			16.6	
WW071313013	13		8.5	17.7	
WW071313014	14		9.5	18.9	
WW071313015	15		11.5	20.1	
WW071313016	16		12	21.2	
WW071313017	17		22.4		
WW071313018	18		23.6		
WW071313019	19	24.8			

Item #	Designation	Length in mm
WW071313001	Ratchet	205
WW071313002	Extension	76
WW071313003	Adapter 1/4"	26
WW071313004	Adapter 3/8"	30
See table below for details	10 sockets, 10-19 mm	32

Ratchet

Head: 72 teeth, 5° rotating angle, round, compact head, one-hand operation with reversing lever for clockwise and counter-clockwise operation
Model: Chrome-plated, polished, very slim design

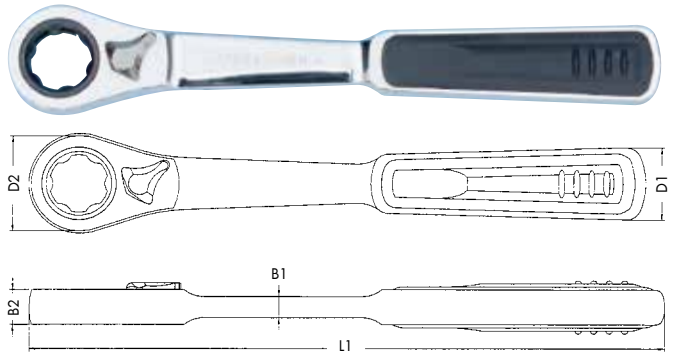

Item #	L1 mm	B1 mm	B2 mm	D1 mm	D2 mm
WW071313001	205	7	11.5	24.7	32.5

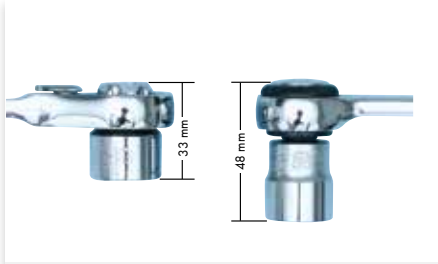

Low height of the through-ratchet as compared to the standard ratchet



Thanks to the through-hole, long bolts and threaded rods can be processed



Through-ratchet with adapter ejector enables an easy removal of the socket spanner

ZEBRA 1/4 INCH SOCKET WRENCH ASSORTMENT



Item # **WW0965900001** 33 piece set



33 pcs, with drive tool

Contents:

- Hexagon socket wrench inserts: SW 4; 5; 5.5; 6; 7; 8; 9; 10; 11; 12; 13; 14
- 100 and 150 mm extension
- Universal joint
- Adapter with quick-change chuck
- 1/4 inch Ratchet
- ZEBRA handle
- 3 bits: PH1; PH2; PH3
- 1 bit slotted 0.8 x 5.5mm
- 7 bits TX: TX10; 15; 20; 25; 27; 30; 40mm
- 4 hexagon bits, sizes 3, 4, 5, 6
- Foam insert

SOCKETS

PLIERS / CUTTERS

ZEBRA 1/2 INCH SOCKET WRENCH ASSORTMENT



Item # **WW0965900201** 17 piece set

17 Pieces

- **Inner TX**
TX 20, TX 25, TX 27, TX 30, TX 40, TX 45, TX 50, TX 55, TX 60.
- **Outer TX**
E 10, E 11, E 12, E 14, E 16, E 18, E 20, E 24
- Foam insert





ZEBRA COMBINATION PLIERS



THE HANDLE IS CRITICAL

Optimal power distribution
– Comfortable grip without pressure points thanks to special handle geometry



Slim collar shape - for optimal accessibility in tight work areas



2K grip for gripping, holding and cutting hard and soft wires and cables

- DIN ISO 5746
 - High-quality steel construction ensures long tool life and precision of gripping and cutting surfaces
 - Extra-long blade also suitable for thicker cables
 - Ergonomic and slip-free 2K comfort handle with narrow collar profile for comfortable working and optimum force transfer
 - Inductively hardened precision blades
 - Burner hole for gripping round materials
 - Surface: Entirely ground and chrome-plated
 - Joint: Lap joint
- Packing & Sold In: Each

Item #	Length (in.)	Length (mm)	Medium-hard wire ●	Hard wire ●	Copper and aluminum cable ☺	
WW071401554	6 - 1/2"	170	3.1 mm diameter	2.0 mm diameter	10.0 mm diameter	16 mm ²
WW071401555	7"	180	3.4 mm diameter	2.2 mm diameter	12.0 mm diameter	
WW071401556	8"	200	3.8 mm diameter	2.5 mm diameter	13.0 mm diameter	

ZEBRA NEEDLE NOSE PLIERS



2K grip for gripping, holding and cutting soft and hard wires and cables

- DIN ISO 5745
- High-quality steel construction ensures long tool life and precision of gripping and cutting surfaces
- Elastic tips for high stresses, especially under bending forces
- Ergonomic and slip-free 2K comfort handle with narrow collar profile for comfortable working and optimum force transfer
- Blades: Additional inductive hardening
- Surface: Entirely ground and chrome-plated
- Gripping surfaces: Toothed
- Joint: Lap joint

Packing & Sold In: Each

Item #	Length (in)	Length (mm)	Tip geometry	Jaw shape	L3 (mm)	W3 (mm)	T1 (mm)	W4 (mm)	T2 (mm)
WW071401557	8-1/4"	210			76	17.5	9.5	4	3
WW071401558					72				
WW071401559	6-1/4"	160			50	16.5	9	3	2.5
WW071401562					46				

ZEBRA SIDE CUTTERS



2K grip for cutting hard and soft wires and cables, including in hard-to-reach places

- DIN ISO 5749
- High-quality tool steel ensures long service life and precision of blades
- Slim head shape for optimum accessibility
- Ergonomic and slip-free 2K comfort handle with narrow collar profile for comfortable working and optimum force transfer
- Inductively hardened precision blades
- Surface entirely ground and chrome-plated
- Lap joint

Packing & Sold In: Each



Milled precision cutting edge saves strength and gives a clean cut!





Item #	Length (in.)	Length (mm)	Soft wire	Medium-hard wire	Hard wire
WW071401566	5 - 1/2"	140	4.0 mm diameter	2.5 mm diameter	1.8 mm diameter
WW071401567	6 - 1/4"	160		2.8 mm diameter	2.0 mm diameter
WW071401568	7"	180		3.0 mm diameter	2.5 mm diameter

ZEBRA POWER SIDE CUTTERS



2K grip for cutting piano wire, hard and soft wire

- DIN ISO 5749
 - Strength-saving. Milled precision cutting edge for clean cuts
 - High-quality steel ensures long service life and precision of blades
 - Ergonomic and slip-free 2K comfort grip handle with narrow collar profile for comfortable working and optimum force transfer
 - Inductively hardened precision blades
 - Surface: Ground and chrome-plated
 - Joint: Lap joint, forged-on rivets
- Packing & Sold In: Each

Item #	Length (in.)	Length (mm)	Soft wire 	Medium-hard wire 	Hard wire 	Piano wire 
WW071401551	5 - 1/2"	140	4.0 mm diameter	3.1 mm diameter	2.0 mm diameter	1.5 mm diameter
WW071401552	6 - 1/4"	160		3.4 mm diameter	2.5 mm diameter	2.0 mm diameter
WW071401553	7"	180		3.8 mm diameter	2.7 mm diameter	2.2 mm diameter
WW071401598	8"	200	4.5 mm diameter	4.2 mm diameter	3.0 mm diameter	2.5 mm diameter

ZEBRA HEAVY-DUTY SIDE CUTTERS, REVERSIBLE



2 tools in one: Side cutters with connectible lever transmission

- High cutting power cuts thick cables
 - Avoids hard cutting impact found with conventional side cutters
 - Precision cutting ensures a long service life
 - Manufactured from high-grade steel
 - Safe handling
 - Ergonomic 2K plastic handle with non-slip surface
 - Surface: Chrome-plated
 - Joint: Launched
- Packing & Sold In: Each







2 in 1!

Side cutters with connectible lever transmission

By pressing the power button, you get twice the cutting power!



Item #	Length (in.)	Length (mm)	Soft wire 	Medium-hard wire 	Hard wire 	Piano wire 
WW071401599	8"	200	5 mm diameter	4.5 mm diameter	3.5 mm diameter	3 mm diameter

ZEBRA WIRE STRIPPING PLIERS



2K grip, precise, effortless stripping of cables and wires with plastic or rubber insulation

- High-quality steel construction
- Long service life and precision of cutting surfaces.
- For single, multi and fine-wire conductors
- Opening spring opens pliers automatically
- Ergonomic and non-slip 2K comfort handle with narrow collar profile
- Comfortable working and optimum power transmission
- Adjustment screw can be fixed in place with knurled nut
- Surface: Entirely ground and chrome-plated
- Joint: Lap joint

Packing & Sold In: Each

Item #	Length (in)	Length (mm)	Diameter (mm)	(mm) ²
WW071401550	6-1/4"	160	5	10

ZEBRA WATER PUMP PLIERS



2K grip, self-locking water pump pliers with push-button adjustment

- DIN ISO 8976
- Rapid and convenient fine adjustment at the push of a button
- Hardened precision teeth
- High wear resistance and secure grip
- Ergonomic and non-slip 2K comfort handle with narrow collar profile
- Comfortable working and optimum power transmission
- Huge gripping capacity with slim design

Packing & Sold In: Each

Item #	Length (in)	Length (mm)	Min./Max. Grip Range
WW071401563	10"	250	16 - 46 mm



With
**PUSH BUTTON
ADJUSTMENT**
and hardened precision teeth

ZEBRA PLIERS AND CUTTERS SETS

WRENCHES

ALLEN KEYS

RIVETERS

SCREWDRIVERS

T-HANDLES

BITS

RATCHETS



Includes:

Item #	Contents	Length (in)	Length (mm)
WW071401555	Zebra	7"	180
WW071401550	Zebra Wire	6-1/4"	160
WW071401557	Zebra Needle	8-1/4"	210



Item # **WW071401560** 4 piece set

2K grip, set of one of each combination pliers, wire stripping pliers, needle nose pliers, and power side cutters

- High-quality steel construction ensures long service life and precision of gripping and cutting surfaces
- Combination pliers with extra-long blade also suitable for thicker cables
- Wire stripping pliers with opening spring for automatic opening
- Needle nose pliers with tips for high bending stresses
- Heavy-duty side cutters for piano wire, hard and soft wire
- Ergonomic and slip-free 2K comfort handle with narrow collar profile for comfortable working and optimum force transfer



Includes:

Item #	Contents	Length (in)	Length (mm)
WW071401555	Zebra	7"	180
WW071401563	Zebra Water	10"	250
WW071401557	Zebra Needle	8-1/4"	210
WW071401552	Zebra Power	6-1/4"	160



Item # **WW071401565** 4 piece set

2K grip, set of one of each combination pliers, water pump pliers, needle nose pliers, and power side cutters

- High-quality steel construction ensures long service life and precision of gripping and cutting surfaces
- Combination pliers with extra-long blade also suitable for thicker cables
- Water pump pliers with convenient quick adjustment
- Needle nose pliers with tips for high bending stresses
- Heavy-duty side cutters for piano wire, hard and soft wire
- Ergonomic and slip-free 2K comfort handle with narrow collar profile for comfortable working and optimum force transfer

ZEBRA PLIERS ASSORTMENT



THE HANDLE IS CRITICAL

Optimal power distribution
– Comfortable grip without pressure points thanks to special handle geometry



Item # **WW0965900600** 4 piece set

2K Grip

- 4 piece set of 2K grip pliers
- Foam drawer insert and cutters

Includes:

Item #	Contents	Length (in)	Length (mm)
WW071401555	Zebra	7"	180
WW071401563	Zebra Water	10"	250
WW071401557	Zebra Needle	8-1/4"	210
WW071401552	Zebra Power	6-1/4"	160



Side cutters:
160 mm



Combination pliers:
180 mm



Needle nose pliers:
210 mm



Water pump pliers:
250 mm



CIRCLIP PLIERS FORM A/B



For shaft locking rings

Standard: DIN 5254

Handle: Plastic-coated

Guarantees a secure grip, prevents slippage

Compressed Spring Steel Tip

- Optimized stability for use with tight fitting and seized rings

Inserted Tips

- Offers maximum strength when loosening tight-fitting/seized rings and allows rings to be installed with minimal distortion

Screwed and Mounted Joint

- High precision and optimized movement

Large Contact Surfaces

- Rings mounted with minimal torsion



Pliers Head

- Slim design for optimum access to work piece, especially in hard-to-reach areas

Internal Spring

- Lies protected in the internal joint

Packing & Sold In: Each

Item #	Length (mm)		Min./Max. grip range	Tenon diameter (mm)	Jaws length (mm)	Hook length (mm)
WW07140211	140		3 - 10	0.9	39	-
WW07140212			10 - 25	1.25	38	
WW07140213			19 - 60	1.8	56	
WW07140214			40 - 100	2.25	70	
WW07140215	320	A Straight	85 - 140	3.2	92	
WW07140216	130		3 - 10	0.9	27	12
WW07140217			10 - 25	1.25		
WW07140218			19 - 60	1.8	40	15
WW07140219			40 - 100	2.25	55	16
WW07140220			305	B 90°	85 - 140	3.2

CIRCLIP PLIERS FORM C/D



For retaining rings (bore circlips)

Standard: DIN 5256

Handle: Plastic-coated

- Guarantees a secure grip, slip-resistant

Compressed Spring Steel Tip

- Optimized stability for use with tight-fitting and seized rings

Inserted Tips

- Offers maximum strength when loosening tight-fitting/seized rings and allows rings to be installed with minimal distortion

Screwed and Mounted Joint

- High precision and optimized movement



Large Contact Surfaces

- Rings mounted with minimal torsion

Pliers Head

- Slim design for optimum access to work piece, especially in hard-to-reach areas

Packing & Sold In: Each

Item #	Length (mm)		Min./Max. grip range	Tenon diameter (mm)	Jaws length (mm)	Hook length (mm)
WW07140201	140		8 - 13	0.9	39	-
WW07140202			12 - 25	1.25	38	
WW07140203			19 - 60	1.8	54	
WW07140204			40 - 100	2.25	65	
WW07140205	320	C Straight	85 - 140	3.2	91	
WW07140206	130		8 - 13	0.9	26	12
WW07140207			12 - 25	1.25		
WW07140208			19 - 60	1.8	40	14
WW07140209			40 - 100	2.25	49	16
WW07140210			305	D 90°	85 - 140	3.2

CIRCLIP PLIER SET (4 PIECES)

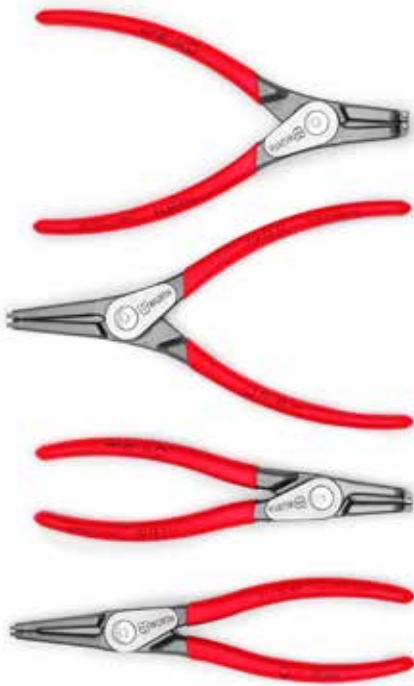

Item # **WW07140230** 4 piece set

4-piece set

Handle: Plastic-coated

- Guarantees a secure grip, prevents slippage

Tip from compressed spring steel

- Optimized stability, even with seized rings

Inserted tips

- Offers maximum strength when loosening seized rings and allows rings to be installed with minimal distortion

Screwed and mounted joint

- High precision and optimized movement

Includes:

Item #	Form / Grip Range
WW07140213	Form A, 19 - 60 mm
WW07140218	Form B, 19 - 60 mm
WW07140203	Form C, 19 - 60 mm
WW07140208	Form D, 19 - 60 mm

Large locating faces

- Rings mounted without torsion

Pliers head

- Narrow design for optimum access to workpiece, including in hard-to-reach spots

Contents:

- Form A Circlip Pliers, 19 - 60 mm grip range
- Form B Circlip Pliers, 19 - 60 mm grip range
- Form C Circlip Pliers, 19 - 60 mm grip range
- Form D Circlip Pliers, 19 - 60 mm grip range

ZEBRA VICE-GRIP LOCKING PLIERS



Features:

- Effortless release lever with spring mechanism
- One-hand operation – pull-action rather than push-action
- Lock nut for fixing clamping width, setting retained for repetitive applications
- Ergonomic design
- Comfortable and effortless handling
- High-quality epoxy coating, welding beads roll off
- 10x better rust resistance than Nickel coatings

Packing & Sold In: Each



Straight jaws

Item #	Length (mm)	Clamping width (mm)
WW07150909	190	0-42
WW07150910	235	0-63



Long straight jaws

Item #	Length (mm)	Clamping width (mm)
WW07150904	235	0-70



Semi-circular jaws

Item #	Length (mm)	Clamping width (mm)
WW07150906	135	0-30
WW07150907	190	0-42
WW07150908	235	0-63

WRENCHES
ALLEN KEYS
RIVETERS
SCREWDRIVERS
T-HANDLES
BITS
RATCHETS





ZEBRA SHEET METAL SNIPS - SHORT LENGTH



Maneuverable , powerful and compact

Double Leverage

- Lower application of force with simultaneously increased cutting performance
- No slipping and no serration

Perfect Design

- Small and lightweight
- Easily stores in most pockets

Extremely Compact Shearing Head

- Ideal for cutting extremely tight radii and for hard-to-reach places

Combined Lock and Stop

- Combined lock and stop for improved safety
- Cutting snips can be quickly and easily closed and kept closed

Ergonomically shaped handle

- Easy to grip
- Allows for lower fatigue

Packing & Sold In: Each

Item #	Version	Length (mm)	Cutting capacity (mm)	
			Steel	Stainless Steel
WW071303200	Right-hand cutting	180	1.2	0.8

ZEBRA SHEET METAL SNIPS



Leverage sheet metal cutting snips for continuous and shaped cuts

Rounded grip made from 2-component plastic

- Prevents hands from slipping

Lower handle made from 1-component plastic

- Simply slide your finger over the lower handle when opening and closing the handle

Handle heights prevent the cutting snips from slipping out of your hand

- Allows for safe execution

Long service life

- Cutting head manufactured from stainless steel, die-forged
- Induction hardened cutting edges

Non-serrated cutting geometry

- Helps prevent sheet metal slipping

Lever transmission

- High cutting power with less effort

Packing & Sold In: Each



Ideal Snips

For continuous and figure cutting

Item #	Version	Length (mm)	Cutting capacity (mm)	
			Steel	Stainless Steel
WW071303100	Right-hand cutting	260	1.8	1.2
WW071303110	Left-hand cutting			



Ideal Carbide Snips

With carbide cutting edges for continuous and figure cutting

- Longer service life
- Especially suitable for cutting stainless steel

Item #	Version	Length (mm)	Cutting capacity (mm)	
			Steel	Stainless Steel
WW071303130	Right-hand cutting	260	1.8	1.2
WW071303135	Left-hand cutting			



Figure Snips

For continuous and tight figure cutting

Item #	Version	Length (mm)	Cutting capacity (mm)	
			Steel	Stainless Steel
WW071303115	Right-hand cutting	260	1.8	1.2
WW071303120	Left-hand cutting			



LIMITED EDITION TOOL SETS

- Limited edition with Reinhold Würth signature
- Tool sizes are marked on the insert for easy organization

Limited Edition Drill And Drive Set, 31 Piece

For more detail -
See wurthbaersupply.com

Item #
WW0624932020



Limited Edition Socket and Drive Set, 46 Piece

For more detail -
See wurthbaersupply.com

Item #
WW09652019



Limited Edition Double Ratcheting Wrench Set, 29 Piece

For more detail -
See wurthbaersupply.com

Item #
WW07142020



WÜRTH BAER SUPPLY LIMITED WARRANTY POLICY - HAND TOOLS

Würth Baer Supply – Limited Warranty Policy

This limited warranty policy (“Limited Warranty Policy”) represents Würth Baer Supply (“the Company”) commitment to our customers and our effort in ensuring the quality of our products.

If you are the original purchaser of our product, the Company warrants, for the time period indicated below (the “Warranty Coverage”), each Würth Baer Supply product to be free from defects in materials and workmanship under normal use and service, when installed, adjusted, used, and maintained, in the manner they were intended.

WÜRTH PRODUCT	WARRANTY COVERAGE
<ul style="list-style-type: none"> • "Zebra" brand hand tools 	<p>Limited lifetime warranty</p> <p>Würth Baer Supply warrants these products for its useful life against deficiencies in material and workmanship</p>
<ul style="list-style-type: none"> • Würth brand hand tools 	<p>1-year Limited Warranty</p> <p>Würth Baer Supply warrants these products for one (1) year from the date of purchase of the original purchaser</p>
<p>Please note that the Limited Lifetime Warranty and the 1-year Limited Warranty are subject to the provisions and limitations contained in this Limited Warranty Policy and in any applicable Würth Baer Supply terms and conditions of sale.</p>	

Repair, replacement (same or similar product), or credit at the original sale price at Würth Baer Supply’s option will be furnished if the product, upon Würth’s standard investigation process, is found to be properly installed, adjusted, used, maintained, stored, and/or operated.

Any such repairs or replacement will be made at no charge to the customer for parts or labor, provided that the customer shall be responsible for any transportation, lodging, meals, and/or other personal costs.

This Limited Warranty Policy does not apply to any malfunctions caused by: (i) normal wear and tear, (ii) unreasonable and/or improper use, misuse, neglect, abuse, improper storage, improper exposure to elements, and/or insufficient maintenance, (iii) repair or service by unauthorized persons, and (iv) modifications and/or alterations made without the express written permission of Würth Baer Supply.

Würth Baer Supply consumable products are free from manufacturer’s defect upon delivery but do not carry any further warranty unless specifically expressed on the product itself.

This limited warranty is non-transferrable and can only be availed by the original purchaser of the product. A proof of purchase is required for all warranty claims. To obtain warranty service, contact your sales representative for warranty assistance or call 1-800-263-5002 for your nearest authorized Würth Baer Supply sales representative.

EXCEPT FOR THE LIMITED WARRANTY PROVIDED HEREIN, TO THE EXTENT PERMITTED BY LAW, WÜRTH DISCLAIMS ALL OTHER WARRANTIES, EXPRESS OR IMPLIED, INCLUDING ALL WARRANTIES OF MERCHANTABILITY AND/OR FITNESS FOR A PARTICULAR PURPOSE. TO THE EXTENT THAT ANY IMPLIED WARRANTIES MAY NONETHELESS EXIST BY OPERATION OF LAW, ANY SUCH WARRANTIES ARE EXPRESSLY LIMITED TO THE WARRANTY COVERAGE PERIOD ASSOCIATED WITH EACH PRODUCT STATED HEREIN.

The terms in this Limited Warranty Policy represent Würth Baer Supply’s exclusive written warranty. Würth Baer Supply makes no other express warranty, nor is anyone authorized to make any warranties on its behalf.

REPAIR OR REPLACEMENT OF Würth Baer Supply PRODUCTS, AS PROVIDED HEREIN, IS YOUR EXCLUSIVE REMEDY. WÜRTH BAER SUPPLY SHALL NOT BE LIABLE FOR ANY SPECIAL, INCIDENTAL, ECONOMIC OR CONSEQUENTIAL DAMAGES, INCLUDING, BUT NOT LIMITED TO, LOST REVENUES, LOST PROFITS, STRICT LIABILITY IN TORT AND/OR IN NEGLIGENCE, AND THIRD PARTY CLAIMS, INCIDENTAL OR CONSEQUENTIAL, LABOR COSTS, INSTALLATION CHARGES, TELEPHONE CHARGES, OR TRANSPORTATION CHARGES IN CONNECTION WITH THE REPLACEMENT AND/OR REPAIR OF DEFECTIVE PARTS OR PRODUCTS.

Customer understands that Würth Baer Supply is a distributor only and as such, Würth Baer Supply assumes no liability whatsoever with regard to the original purchaser’s compliance or fulfillment of its obligations with respect to any statute, regulation, or by-law. Please note that while Würth Baer Supply has made diligent efforts to illustrate and describe the products shown in its catalogues and online media, these illustrations and descriptions however, are for the sole purpose of identification and do not express nor imply a warranty or condition that the products shown are merchantable, fit for a particular purpose, nor does it guarantee that the products will necessarily conform to the illustrations and descriptions. Würth Baer Supply reserves the right to make changes in design, appearance, and construction of any and all Würth Baer Supply products and reserves the right to discontinue the availability of any products and/or service to any discontinued products, at any time, at its sole discretion. Würth Baer Supply assumes no responsibility whatsoever in making such changes in products



Würth Baer Supply

HAND TOOLS

Würth Baer Supply

909 Forest Edge Drive
Vernon Hills, IL 60061
T: 800-289-2237
F: 888-558-2237
www.wuerthbaersupply.com

Other locations:

Bethlehem, PA
Brooklyn Heights, OH
Columbus, OH
Eagan, MN
Edison, NJ
Elk Grove Village, IL

Guilderland Ctr, NY
Harrisburg, PA
Indianapolis, IN
Kansas City, MO
Leetsdale, PA
Londonderry, NH
Middletown, OH

Oak Park, MI
Pennsauken, NJ
Pewaukee, WI
Rumford, RI
Syracuse, NY
Versailles, KY
West Haven, CT