

SECTION O - TABLE OF CONTENTS

Section O Contents:

Bed Hardware.....2 - 3
 Barn Door Hardware.....4 - 21
 Bi-Fold Sliding Door Hardware.....22 - 33
 Rolling Ladder Hardware.....34 - 39
 Sliding Cabinet Door Tracks.....40 - 44
 Sliding Door Pulls.....45 - 46
 Hooks & Handrail Brackets.....47 - 52
 Spring Hinges & Pivot Hinges.....53 - 55
 Passage Door Hardware.....56 - 58
 Bath Hardware.....59 - 61
 Wall Plates.....62 - 67
 Toilet Partition Hardware.....68 - 71
 Bar & Foot Railing Hardware.....72 - 76



↑ Barn Door Hardware, pages O-4 - O-21



Hooks, pages O-47 - O-52 ↑



↑ Handrail Bracket, page O-53



↑ Hinges, pages O-53 - O-55



↑ Toilet Partition Hardware, pages O-68 - O-71 ↑



↑ Wall Beds, pages O-2 & O-3 ↑



↑ Rolling Ladder, pages O-34 - O-39



A
B
C
D
E
F
G
H
I
J
K
L
M
N
O
P
Q
R
S
T
U
V
W
X
Y

A
B
C
D
E
F
G
H
I
J
K
L
M
N
O
P
Q
R
S
T
U
V
W
X
Y

BED HARDWARE - VERTICAL



Wall Bed Hardware Vertical Mount Kit



- Completely secure, easy to operate and assemble
- Sturdy tubular steel construction provides years of reliable use
- Designed for mattresses up to 10" thick
- Door stays closed without requiring a latch
- Semi-assembled frame for easy shipping
- 5 Years Limited Warranty
- **Kit Includes: Sturdy steel frame, poplar slats, mounting brackets, pistons, legs with connecting bar, mattress retaining brackets and assembly hardware**
- This kit does not include a mattress or a cabinet
- Must ship on a truck

Item #	Description	Load Rating		Weight
		Dynamic	Static	
SZWALLBED-TWIN-VT	Twin Size Wall Bed, Vertical Kit	300 Lbs.	1,000 Lbs.	54.6 Lbs.
SZWALLBED-FULL-VT	Full Size Wall Bed, Vertical Kit	340 Lbs.	1,000 Lbs.	88 Lbs.
SZWALLBED-QUEEN-VT	Queen Size Wall Bed, Vertical Kit	400 Lbs.	1,000 Lbs.	96 Lbs.

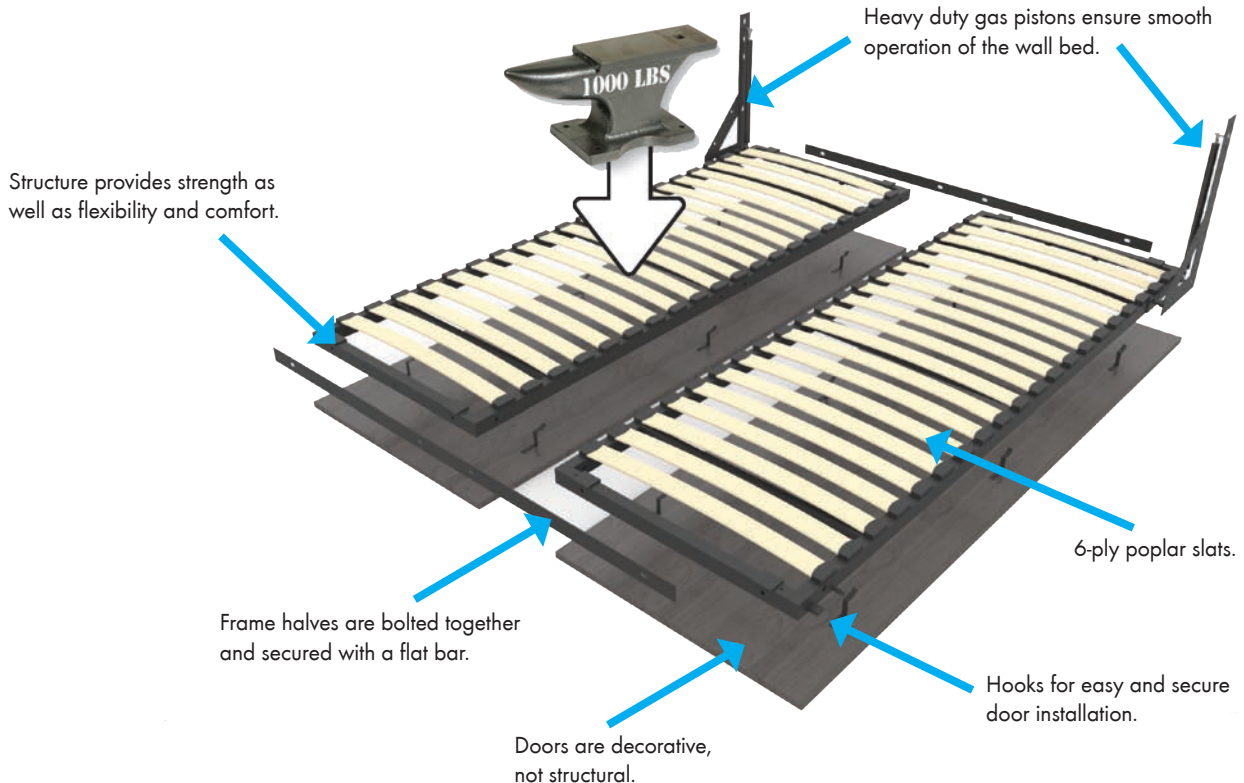

BED HARDWARE - HORIZONTAL



Wall Bed Hardware Horizontal Mount Kit



- Completely secure, easy to operate and assemble
- Sturdy tubular steel construction provides years of reliable use
- Designed for mattresses up to 10" thick
- Door stays closed without requiring a latch
- Semi-assembled frame for easy shipping
- 5 Years Limited Warranty
- **Kit Includes: Sturdy steel frame, poplar slats, mounting brackets, pistons, legs with connecting bar, mattress retaining brackets and assembly hardware**
- This kit does not include a mattress or a cabinet
- Must ship on a truck

Item #	Description	Load Rating		Weight
		Dynamic	Static	
SZWALLBED-TWIN-HZ	Twin Size Wall Bed, Horizontal Kit	300 Lbs.	1,000 Lbs.	54 Lbs.
SZWALLBED-FULL-HZ	Full Size Wall Bed, Horizontal Kit	340 Lbs.	1,000 Lbs.	95.7 Lbs.
SZWALLBED-QUEEN-HZ	Queen Size Wall Bed, Horizontal Kit	400 Lbs.	1,000 Lbs.	111.60 Lbs.

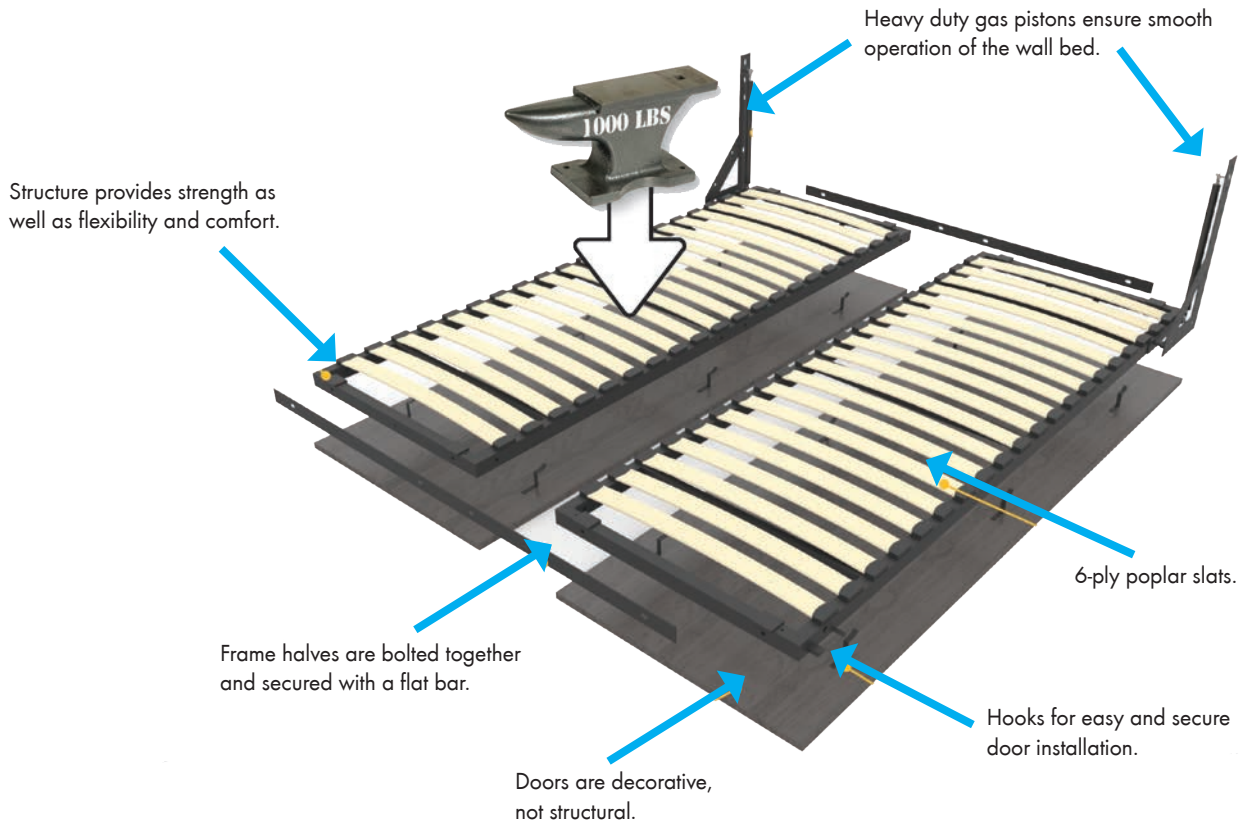

A
B
C
D
E
F
G
H
I
J
K
L
M
N
O
P
Q
R
S
T
U
V
W
X
Y

A BARN DOOR HARDWARE

Flat Rail Kits with Soft-Close Option

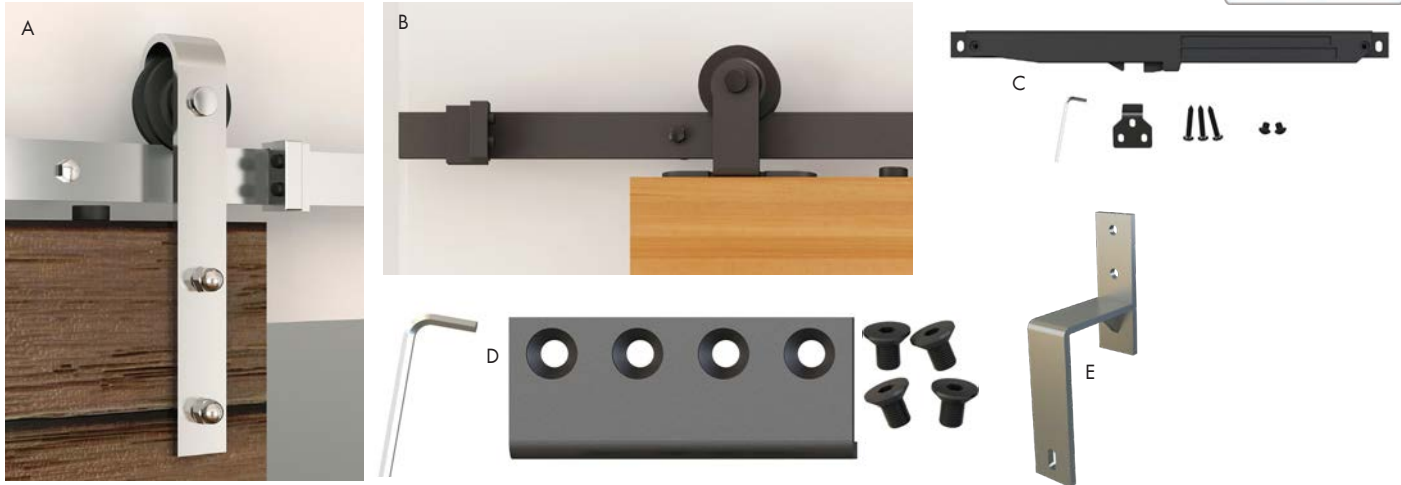

	Item#	Type	Material	Finish	Kit Includes
Barn Door Hardware Flat Rail Kits - Face Mount - Maximum Door Weight: 350 lbs.					
A	UF77214-51-005	Face Mount	Steel	Matte Black	(1) 78" L Flat Rail, (5) Clamps for Fixing to Rail, (2) Door Stoppers, (2) Anti-Jump Blocks, (2) Sliding Door Rollers, & (1) Floor Guide
	UF77214-53-007	Face Mount	Steel	Oil Rubbed Bronze	(1) 78" L Flat Rail, (5) Clamps for Fixing to Rail, (2) Door Stoppers, (2) Anti-Jump Blocks, (2) Sliding Door Rollers, & (1) Floor Guide
	UF77214-56-006	Face Mount	Stainless Steel	Stainless Steel	(1) 78" L Flat Rail, (5) Clamps for Fixing to Rail, (2) Door Stoppers, (2) Anti-Jump Blocks, (2) Sliding Door Rollers, & (1) Floor Guide
Barn Door Hardware Flat Rail Kits - Top Mount - Maximum Door Weight: 300 lbs.					
B	UF77224-51-008	Top Mount	Steel	Matte Black	(1) 78" L Flat Rail, (5) Clamps for Fixing to Rail, (2) Door Stoppers, (2) Anti-Jump Blocks, (2) Sliding Door Rollers, & (1) Floor Guide
	UF77224-56-009	Top Mount	Stainless Steel	Stainless Steel	(1) 78" L Flat Rail, (5) Clamps for Fixing to Rail, (2) Door Stoppers, (2) Anti-Jump Blocks, (2) Sliding Door Rollers, & (1) Floor Guide
Accessories - Soft-Close Mechanism for Flat Rail Barn Door Hardware Only					
C	UF77253-51-100	Soft-Close Mechanism, Matte Black Finish			
	UF77253-53-108	Soft-Close Mechanism, Oil Rubbed Bronze Finish			
	UF77253-56-109	Soft-Close Mechanism, Stainless Steel Finish			
Accessories - Designed for Flat Rail Barn Door Hardware Only					
D	UF77259-51-104	Flat Rail Connector, Connects Two Flat Rails Together, Matte Black Finish			
	UF77259-53-106	Flat Rail Connector, Connects Two Flat Rails Together, Oil Rubbed Bronze Finish			
	UF77259-56-105	Flat Rail Connector, Connects Two Flat Rails Together, Stainless Steel Finish			
E	UF77919-51-101	Bypass Door Brackets, Designed for Two Door Application, Matte Black Finish			
	UF77919-53-103	Bypass Door Brackets, Designed for Two Door Application, Oil Rubbed Bronze Finish			
	UF77919-56-102	Bypass Door Brackets, Designed for Two Door Application, Stainless Steel Finish			

BARN DOOR HARDWARE

Round Rail Kits with Soft-Close Option



Item#	Type	Material	Finish	Kit Includes	
Barn Door Hardware Round Rail Kits - Face Mount - Maximum Door Weight: 260 lbs.					
A	UF77114-56-001	Face Mount	Stainless Steel	Stainless Steel	(1) 78"L Round Rail, (4) Clamps for Fixing to Rail, (2) Door Stoppers, (2) End Caps, (2) Sliding Door Rollers, (1) Floor Guide, & (1) Tool
	UF77113-56-002	Face Mount w/Soft-Close	Stainless Steel	Stainless Steel	(1) 78"L Round Rail, (4) Clamps for Fixing to Rail, (2) Door Stoppers, (2) End Caps, (2) Sliding Door Rollers, (1) Floor Guide, (1) Tool, (2) Soft-Closing Mechanisms, & (2) Triggers for the Soft-Close
Barn Door Hardware Round Rail Kits - Top Mount - Maximum Door Weight: 260 lbs.					
B	UF77124-56-003	Top Mount	Stainless Steel	Stainless Steel	(1) 78"L Round Rail, (4) Clamps for Fixing to Rail, (2) Door Stoppers, (2) End Caps, (2) Sliding Door Rollers, & (1) Floor Guide
	UF77123-56-004	Top Mount w/Soft-Close	Stainless Steel	Stainless Steel	(1) 78"L Round Rail, (4) Clamps for Fixing to Rail, (2) Door Stoppers, (2) End Caps, (2) Sliding Door Rollers, (1) Floor Guide, (2) Soft-Closing Mechanisms, & (2) Triggers for the Soft-Close
Accessory - Round Rail Connector					
C	UF77159-56-107	Round Rail Connector, designed to connect two round rails together, Stainless Steel Finish			

A
B
C
D
E
F
G
H
I
J
K
L
M
N
O
P
Q
R
S
T
U
V
W
X
Y

A BARN DOOR HARDWARE

Mini-Barn Door Hardware

Face Mount Kit

- Applications: kitchen islands, bathroom vanities, dressers, decorative window covering, & hidden TV solution
- Suitable for door thickness of 1" - 1-3/16" (25 - 30 mm)
- Door Weight Capacity: 44 Lbs.
- Available Finishes: Matte Black
- Steel with powder coat
- Kit Includes:
 - (1) 70" L Flat Rail
 - (5) Clamps for Fixing to Rail
 - (2) Door Stoppers
 - (2) Anti-Jump Blocks
 - (2) Sliding Door Rollers
 - (1) Floor Guide
 - (1) Allen Key & Screws



Item #	Description	Finish
UF77214-51-010	Mini-Barn Door Hardware Flat Rail Kit, Face Mount	Matte Black
UF77219-51-136	Accessory - Extra Sliding Door Roller, Face Mount	Matte Black

Mini-Barn Door Hardware

Top Mount Kit

- Applications: kitchen islands, bathroom vanities, dressers, decorative window covering, & hidden TV solution
- Suitable for door thickness of 1" - 1-3/16" (25 - 30 mm)
- Door Weight Capacity: 44 Lbs.
- Available Finishes: Matte Black
- Steel with powder coat
- Kit Includes:
 - (1) 70" L Flat Rail
 - (5) Clamps for Fixing to Rail
 - (2) Door Stoppers
 - (2) Anti-Jump Blocks
 - (2) Sliding Door Rollers
 - (1) Floor Guide
 - (1) Allen Key & Screws

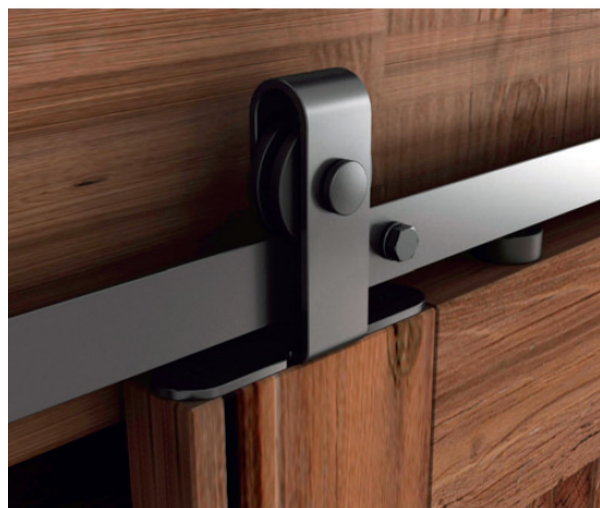

Item #	Description	Finish
UF77224-51-011	Mini-Barn Door Hardware Flat Rail Kit, Top Mount	Matte Black
UF77229-51-135	Accessory - Extra Sliding Door Roller, Top Mount	Matte Black

REGULAR & MINI BARN DOOR ACCESSORIES

C-Guides/T-Guides/Latches



	Item #	Description	Finish
A	UF77919-51-110	C-Guide for Regular & Mini Barn Door	Matte Black
	UF77919-53-111	C-Guide for Regular & Mini Barn Door	Oil Rubbed Bronze
	UF77919-56-112	C-Guide for Regular & Mini Barn Door	Stainless Steel
B	UF77919-51-113	T-Guide for Regular & Mini Barn Door	Matte Black
	UF77919-53-114	T-Guide for Regular & Mini Barn Door	Oil Rubbed Bronze
	UF77919-56-115	T-Guide for Regular & Mini Barn Door	Stainless Steel
C	UF77519-51-201	Latch for Regular & Mini Barn Door	Matte Black
	UF77519-53-202	Latch for Regular & Mini Barn Door	Oil Rubbed Bronze
	UF77519-59-200	Latch for Regular & Mini Barn Door	Satin Nickel

Handles



	Item #	Style	Finish		Item #	Description	Finish
A	UF77519-51-307	Rectangle	Matte Black	E	UF77519-51-316	Rounded	Matte Black
	UF77519-53-308	Rectangle	Oil Rubbed Bronze		UF77519-53-317	Rounded	Oil Rubbed Bronze
	UF77519-59-306	Rectangle	Satin Nickel		UF77519-59-315	Rounded	Satin Nickel
B	UF77519-51-310	Fleur-de-lys	Matte Black	F	UF77539-51-301	6.5"OL Flush	Matte Black
	UF77519-53-311	Fleur-de-lys	Oil Rubbed Bronze		UF77539-53-302	6.5"OL Flush	Oil Rubbed Bronze
	UF77519-59-309	Fleur-de-lys	Satin Nickel		UF77539-59-300	6.5"OL Flush	Satin Nickel
C	UF77519-51-313	Octagon	Matte Black	G	UF77539-51-304	8"OL Flush	Matte Black
	UF77519-53-314	Octagon	Oil Rubbed Bronze		UF77539-53-305	8"OL Flush	Oil Rubbed Bronze
	UF77519-59-312	Octagon	Satin Nickel		UF77539-59-303	8"OL Flush	Satin Nickel
D	UF77519-51-319	Spade	Matte Black				
	UF77519-53-320	Spade	Oil Rubbed Bronze				

Note: All handles are non-stock items and the delivery is 10-12 working days.

A
B
C
D
E
F
G
H
I
J
K
L
M
N
O
P
Q
R
S
T
U
V
W
X
Y

A
B
C
D
E
F
G
H
I
J
K
L
M
N
O
P
Q
R
S
T
U
V
W
X
Y

BARN DOOR HARDWARE

Quiet Glide Round Rail Collection

Note: All items are non-stock. Ship direct from manufacturer.



Bring the trendy yet timeless style of our premium-quality rolling barndoor hardware to your home! The Quiet Glide Round Rail is by far our most customizable collection—from tastefully rustic to simple and modern, you can create a design to suit any space.

With moveable brackets for easy, universal installation and sturdy construction that supports a max recommended 250 lbs, the Quiet Glide Round Rail hardware will be a practical and stylish addition to your home!

1 Select Roller Straps



Hand-Forged, Hammered Traditional Style

Forged by a local Wisconsin blacksmith, these Spade and Fleur-de-Lis straps are custom-made exclusively for Quiet Glide. Includes fasteners and rollers.



Item #	Style	Color
QG110407	Spade	Oil Rubbed Bronze
QG110408	Spade	Black
QG110409	Spade	New Age Rust
QG120407	Fleur-de-Lis	Oil Rubbed Bronze
QG120408	Fleur-de-Lis	Black
QG120409	Fleur-de-Lis	New Age Rust

Contemporary Strap - Best Sellers!

Laser-cut steel and powder-coated finish. Includes fasteners and rollers. Choose strap style and finish (right).

Item #	Finish
Round Stick	
QG1304RS02	Satin Nickel
QG1304RS07	Oil Rubbed Bronze
QG1304RS08	Black
QG1304RS09	New Age Rust
Hook	
QG1304HK02	Satin Nickel
QG1304HK07	Oil Rubbed Bronze
QG1304HK08	Black
QG1304HK09	New Age Rust
Basic Rectangle	
QG1304BR02	Satin Nickel
QG1304BR07	Oil Rubbed Bronze
QG1304BR08	Black
QG1304BR09	New Age Rust
Stick	
QG1304ST02	Satin Nickel
QG1304ST07	Oil Rubbed Bronze
QG1304ST08	Black
QG1304ST09	New Age Rust

Item #	Finish
Horseshoe	
QG1304HS02	Satin Nickel
QG1304HS07	Oil Rubbed Bronze
QG1304HS08	Black
QG1304HS09	New Age Rust
Top Mount	
QG1304TM02	Satin Nickel
QG1304TM07	Oil Rub Bronze
QG1304TM08	Black
QG1304TM09	New Age Rust
Non-Hammered Spade	
QG1104NH07	Oil Rubbed Bronze
QG1104NH08	Black
QG1104NH09	New Age Rust
Vista	
QG1304V02	Satin Nickel
QG1304V07	Oil Rub Bronze
QG1304V08	Black
QG1304V09	New Age Rust



See next page for item numbers.

Available Finishes:

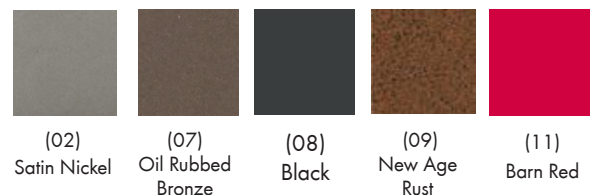

BARN DOOR HARDWARE

1 Select Roller Straps - Continued

Note: All items are non-stock. Ship direct from manufacturer.



Item #	Finish
Cube Stick	
QG1304CS02	Satin Nickel
QG1304CS07	Oil Rub Bronze
QG1304CS08	Black
QG1304CS09	New Age Rust
Notched Rectangle	
QG1304NR02	Satin Nickel
QG1304NR07	Oil Rub Bronze
QG1304NR08	Black
QG1304NR09	New Age Rust

Item #	Finish
Non-Hammered Fleur-de-Lis	
QG1204NH07	Oil Rub Bronze
QG1204NH08	Black
QG1204NH09	New Age Rust
Tri-Star	
QG1304TS02	Satin Nickel
QG1304TS07	Oil Rub Bronze
QG1304TS08	Black
QG1304TS09	New Age Rust

Item #	Finish
Palm-Leis	
QG1304PL02	Satin Nickel
QG1304PL07	Oil Rub Bronze
QG1304PL08	Black
QG1304PL09	New Age Rust
QG1304PL11	Barn Red
Circles	
QG1304C02	Satin Nickel
QG1304C07	Oil Rub Bronze
QG1304C08	Black
QG1304C09	New Age Rust

Item #	Finish
Wright	
QG1304WR02	Satin Nickel
QG1304WR07	Oil Rub Bronze
QG1304WR08	Black
QG1304WR09	New Age Rust
QG1304WR11	Barn Red
Kaminski Wolf	
QG1304NK02	Satin Nickel
QG1304NK07	Oil Rub Bronze
QG1304NK08	Black
QG1304NK09	New Age Rust

2 Select Round Aluminum Rails

Round Aluminum Rail for Rolling Barn Doors

Hang your rolling barn doors on sturdy, solid, 1" diameter aluminum rails. You can even join multiple rails together using splice kits.



Item #	Length	Finish
QG400402	4'	Satin Nickel
QG400407	4'	Oil Rub Bronze
QG400408	4'	Black
QG400409	4'	New Age Rust
QG400602	6'	Satin Nickel
QG400607	6'	Oil Rub Bronze
QG400608	6'	Black
QG400609	6'	New Age Rust
QG400802	8'	Satin Nickel
QG400807	8'	Oil Rub Bronze
QG400808	8'	Black
QG400809	8'	New Age Rust

Standard End Cap Kit for Round Rails

Made out of solid Steel. Each kit includes 2 caps (1-1/4" dia.) and 2 fastening bolts (1/4" #20 x 18mm)



Item #	Finish
QG4002	Satin Nickel
QG4007	Oil Rub Bronze
QG4008	Black
QG4009	New Age Rust

Ball End Cap Kit for Round Rails

Made of Aluminum. Ball cap measures 1-1/2" dia. and has a 1/4" 20 screw. Each kit includes 2 ball caps.



Item #	Finish
QG40102	Satin Nickel
QG40107	Oil Rub Bronze
QG40108	Black
QG40109	New Age Rust

Splice Kit for Joining Round Rails Together



Item #	Size
QG41	1/2" x 1/8" Bar

Thread Tap Accessory

Accessory used to make threads at the end of rails for end caps.



Item #	Size
QGTAP1420	1/4" x 20 Tap

Center Door Stop for Biparting Applications

Stops your biparting door(s) in the middle where rails are joined. Use with two rail sections and splice kit.

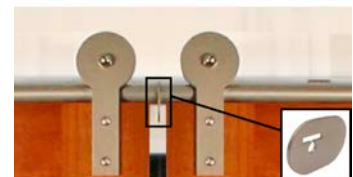

Item #	Finish
QG40202	Satin Nickel
QG40207	Oil Rub Bronze
QG40208	Black
QG40209	New Age Rust



Our solid round rails come extruded with a special profile. This allows for easy attachment to wall mounting brackets, end caps and splice kits.

A
B
C
D
E
F
G
H
I
J
K
L
M
N
O
P
Q
R
S
T
U
V
W
X
Y

A BARN DOOR HARDWARE

3 Select Wall-Mounting Brackets

Wall-Mounting Bracket for Round Rails

Choose between short and long brackets (depending on how far you want the door from the wall). Sold as each. Screws are included.

Brackets are used to mount the round rail to the wall.

Recommended spacing between brackets is 16".

Wall Brackets must be mounted securely into a wood header. If the brackets are to be mounted to the moulding surrounding the opening of the door, the moulding must be firmly secured to the wall framework.



Short Bracket

For doors up to 1-5/8" thick.

Item #	Finish
QG20302	Satin Nickel
QG20307	Oil Rub Bronze
QG20308	Black
QG20309	New Age Rust

Long Bracket

For doors up to 2-1/4" thick.

Item #	Finish
QG20102	Satin Nickel
QG20107	Oil Rub Bronze
QG20108	Black
QG20109	New Age Rust

4 Select Door Guides & Stops



Universal Guide/Stop, Non-Handed

This product can be used as either a guide or a door stop, mounted onto the floor or to the wall. Sold as each.

Item #	Size	Finish
Use with Short Bracket (QG203 **)		
QG13060102	1-7/8"	Satin Nickel
QG13060107	1-7/8"	Oil Rub Bronze
QG13060108	1-7/8"	Black
QG13060109	1-7/8"	New Age Rust
Use with Long Bracket (QG201 **)		
QG13060202	2-1/2"	Satin Nickel
QG13060207	2-1/2"	Oil Rub Bronze
QG13060208	2-1/2"	Black
QG13060209	2-1/2"	New Age Rust

	Item #	Description	Finish
Hand Forged, Hammered Spade Center Guide			
A	QG110107	Guide can be adjusted to accommodate various door thicknesses. Rear bracket and screws are included.	Oil Rubbed Bronze
	QG110108		Black
	QG110109		New Age Rust
Hand Forged, Hammered Fleur-de-Lis Center Guide			
B	QG120107	Guide can be adjusted to accommodate various door thicknesses. Rear bracket and screws are included.	Oil Rubbed Bronze
	QG120108		Black
	QG120109		New Age Rust

	Left Stop Item #	Right Stop Item #	Description	Finish
Hand Forged, Hammered Spade Door Stop				
C	QG110207	QG110307	Includes screws and a rubber bumper. Left and right stops sold separately.	Oil Rubbed Bronze
	QG110208	QG110308		Black
	QG110209	QG110309		New Age Rust
Hand Forged, Hammered Fleur-de-Lis Door Stop				
D	QG120207	QG120307	Includes screws and a rubber bumper. Left and right stops sold separately.	Oil Rubbed Bronze
	QG120208	QG120308		Black
	QG120209	QG120309		New Age Rust

Note: All items are non-stock. Ship direct from manufacturer.

BARN DOOR HARDWARE

4 Select Door Guides & Stops - Continued

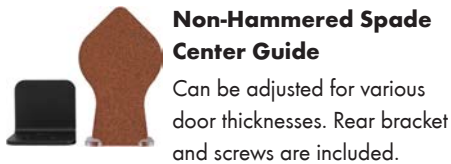

Non-Hammered Spade Center Guide

Can be adjusted for various door thicknesses. Rear bracket and screws are included.

Item #	Finish
QG1101NH07	Oil Rubbed Bronze
QG1101NH08	Black
QG1101NH09	New Age Rust



Non-Hammered Spade Door Stop

Includes screws and a rubber bumper. Left and right stops sold separately.

Item #	Finish
Left Stop	
QG1102NH07	Oil Rubbed Bronze
QG1102NH08	Black
QG1102NH09	New Age Rust
Right Stop	
QG1103NH07	Oil Rubbed Bronze
QG1103NH08	Black
QG1103NH09	New Age Rust



Door Floor Guides with Slotted Bottom

Item #	Type	Includes
QGNT140308	Black Plastic	(2) 1" Screws & Anchors
QGNT1413SS	Stainless Steel	(2) 1" Screws & Anchors
QG1303FG07	Brown Plastic	(2) 11/16" Screws



Plastic Channel

Use with the Brown Plastic Floor Guide. Can be trimmed to size.

Item #	Size
QG1313CH3607	36"
QG1313CH4807	48"



Non-Hammered Fleur-de-Lis Center Guide

Can be adjusted for various door thicknesses. Rear bracket and screws are included.

Item #	Finish
QG1201NH07	Oil Rubbed Bronze
QG1201NH08	Black
QG1201NH09	New Age Rust

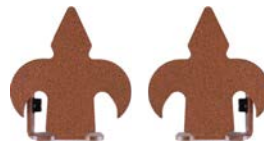

Non-Hammered Fleur-de-Lis Door Stop

Each stop includes screws and a rubber bumper. Left and right stops sold separately.

Item #	Finish
Left Stop	
QG1202NH07	Oil Rubbed Bronze
QG1202NH08	Black
QG1202NH09	New Age Rust
Right Stop	
QG1203NH07	Oil Rubbed Bronze
QG1203NH08	Black
QG1203NH09	New Age Rust



Roller Center Guide for Rough Door Surfaces

Rolling guide for doors with rough surfaces (reclaimed barn wood or rustic finishes). Constructed of heavy duty black Delron polymer, this guide also includes a mounting bolt.

Item #	Length	Color
QG100008	2-13/16"	Black



Steel Round Rail Door Stop

Stops the door from the top instead of the bottom. Mount onto the round rail. Includes a rubber ring to protect door hardware. Fasteners included.

Note: Additional center floor guides required to keep door rolling in a straight path.

Item #	Color
QGNT140402	Satin Nickel
QGNT140407	Oil Rubbed Bronze
QGNT140408	Black



Dome Door Stop, Non-Handed

Stops are interchangeable, can be used left or right stop.

Includes screws and a rubber bumper.

Item #	Finish
QG1305DS02	Satin Nickel
QG1305DS07	Oil Rubbed Bronze
QG1305DS08	Black
QG1305DS09	New Age Rust



Dome Center Guide

Can be adjusted for various door thicknesses. Rear bracket and screws are included.

Item #	Finish
QG1301DG02	Satin Nickel
QG1301DG07	Oil Rubbed Bronze
QG1301DG08	Black
QG1301DG09	New Age Rust

Note: All items are non-stock. Ship direct from manufacturer.

A BARN DOOR HARDWARE

American Home Collection

This collection is based on our Quiet Glide Round Rail, but was designed with two goals: simplicity and savings! The American Home collection gives you the striking and practical design you are looking for, yet allows you to save some money by simplifying the kits.

The kits come in a beautiful black powder-coated finish, 6' rails, and a variety of strap styles that are ready to complement any decor.



Each Kit Includes:

- 2 - Straps with Rollers
- 2 - 3' Round Rail Segments
- 2 - Rail End Caps
- 1 - Round Rail Splice Kit
- 5 - Short Round Rail Brackets
- 2 - Floor Guides
- 2 - Floor Stops
- All necessary fasteners
- (kits only available in Black)



Note: All items are non-stock. Ship direct from manufacturer.



- Each kit sold as a packaged 6' kit
- Two 3' rail segments spliced together
- Package weighs 7.47 lbs.
- Compatible for doors up to 1-5/8" thick
- Max. weight capacity is 150 lbs.
- Low-cost shipping via UPS or FedEx

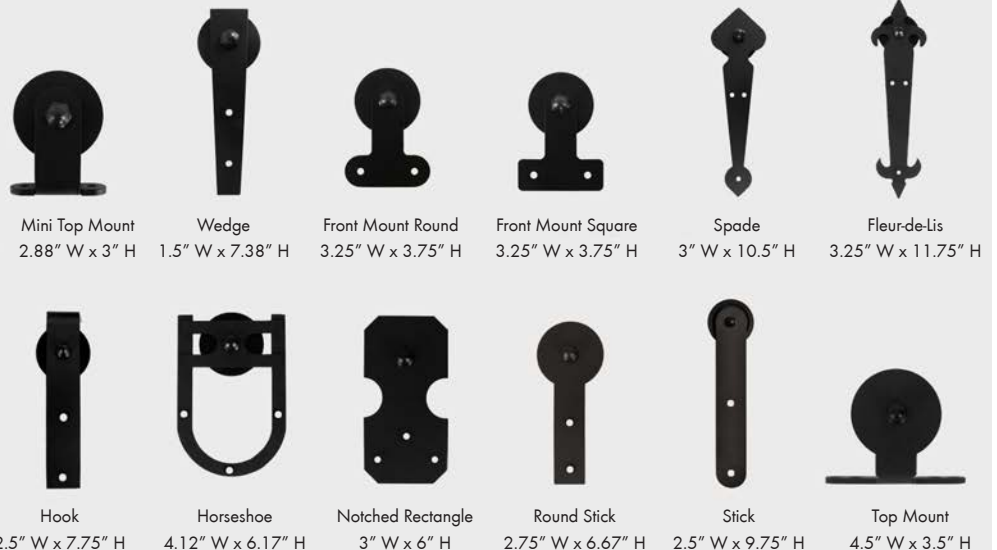

American Home Collection Kit, Black

Item #	Strap Style
QG1310E0108-6S	Mini Top Mount
QG1310E0208-6S	Wedge
QG1310E0308-6S	Front Mount Round
QG1310E0408-6S	Front Mount Square
QG1110ENH08-6S	Spade
QG1210ENH08-6S	Fleur-de-Lis
QG1310EBR08-6S	Basic Rectangle

Item #	Strap Style
QG1310ECS08-6S	Cube Stick
QG1310EHK08-6S	Hook
QG1310EHS08-6S	Horseshoe
QG1310ENR08-6S	Notched Rectangle
QG1310ERS08-6S	Round Stick
QG1310EST08-6S	Stick
QG1310ETM08-6S	Top Mount

BARN DOOR HARDWARE

Round Rail Bypassing Hardware

Introducing the perfect way to install a bypassing door using either our Quiet Glide Round Rail or American Home collection rolling barn door kits! Each kit includes everything you need to combine two sets of rolling barn door hardware into a beautiful and impressive bypassing door.

Please note that the barn door hardware kits themselves are sold separately from bypassing hardware kits.

Round Rail Bypassing Hardware Kit

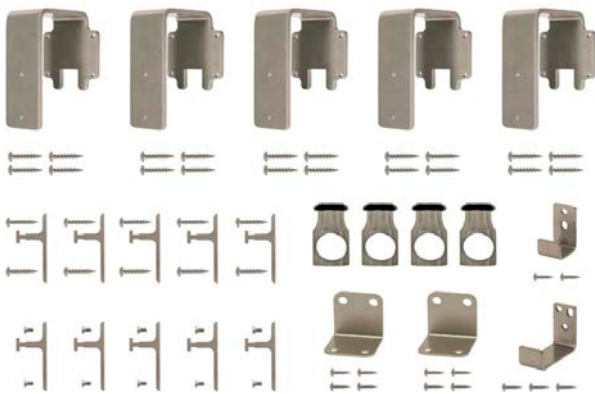

Kit Includes:

- 5 - Bypassing Brackets
- 5 - Rail Brackets w/ Long Screws
- 5 - Rail Brackets w/ Short Screws
- 4 - Steel Door Stoppers
- 1 - Wall-Mounted Guide
- 1 - Floor-Mounted Guide
- 2 - Stop Slots
- All necessary fasteners

Note: All items are non-stock. Ship direct from manufacturer.



Compatible with both the Quiet Glide Round Rail and the American Home kits.

Round Rail Bypassing Hardware Add-On Kit

- Available in three finishes
- Heavy Duty 1/4" Steel
- Overall Dimensions: 5-5/8" H x 3-1/4" D x 3-1/4" W



Item #	Finish
QG13120102	Satin Nickel
QG13120107	Oil Rubbed Bronze
QG13120108	Black

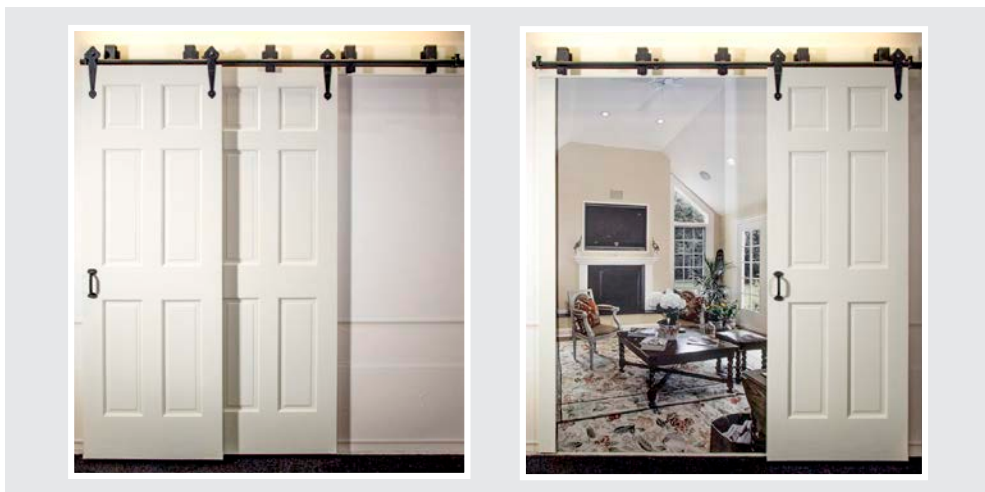

A
B
C
D
E
F
G
H
I
J
K
L
M
N
O
P
Q
R
S
T
U
V
W
X
Y

A BARN DOOR HARDWARE

Quiet Glide Flat Rail Collection

This hardware is Quiet Glide's Premium-quality take on the flat-rail style of rolling barn door hardware. The minimal contact surface area between the flat rail design and the high-density nylon wheel make for extra quiet operation, and the hardware safely supports a max recommended weight of 250 lbs.

Beautifully traditional yet striking, the simple aesthetics of Quiet Glide's Flat Rail Collection are sure to accent your unique decor!



Each 6' Flat Rail Kit Includes:

- 2 - Straps with Rollers
 - 1 - 6' Flat Rail Segment
 - 1 - Stop Kit
 - 5 - Flat Rail Mounting Brackets
 - 1 - Floor Center Guide
- All necessary fasteners



Available Finishes:



Note: All items are non-stock. Ship direct from manufacturer.

Flat Rail 6' Kits:



Rail Accessories:

Our kits have all the parts you need for a standard 6' rolling door application. If you wish to customize your door (including having a rail longer than 6'), we have additional components available for purchase.

4', 6' & 8' Rail (can be cut to size) →

These aluminum rails are sturdy, yet easy to cut. Each rail measures 2" high. 5/16" holes must be drilled through rail in order to fasten to mounting brackets.

5/16" Drill Bit



Item #
QGDRILLBIT5169

Flat Rail Bracket Kit



Includes (1) bracket, (1) lag bolt and (1) washer. For doors up to 1-3/4"

Item #	Finish
QGFR20108	Black

Splice Kit for Joining Flat Rails Together

Item #	Finish
QGFR4108	Black

Item #	Size	Finish
QGFR400408	4'	Black
QGFR400409	4'	New Age Rust
QGFR400608	6'	Black
QGFR400609	6'	New Age Rust
QGFR400808	8'	Black
QGFR400809	8'	New Age Rust

Flat Rail Stop Kit

Includes (2) stops and fasteners.

Item #	Finish
QGFR4008	Black
QGFR4009	New Age Rust



Floor Guide for Doors with a Slotted Bottom

Item #	Finish
QGNT140308	Black Plastic
QG1303FG07	Brown Plastic



Plastic Channel

Use with the Brown Plastic Floor Guide. Protects the door from wear and tear. Can be trimmed to size.

Item #	Size
QG1313CH3607	36"
QG1313CH4807	48"



A
B
C
D
E
F
G
H
I
J
K
L
M
N
O
P
Q
R
S
T
U
V
W
X
Y

BARN DOOR HARDWARE



Heavy Duty Kits

Want that authentic, heavy duty barn door look and feel on an interior door? This is the hardware you're looking for.



This kit is heavy duty in more than just name and appearance with large metal wheels and a sturdy flat rail, this hardware has a max recommended weight capacity of 550 lbs! It's the perfect match for that heavy rustic door that would make such a beautiful addition to your home.

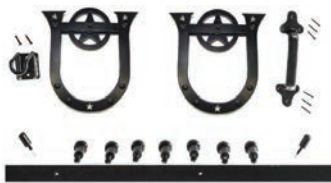

Heavy Duty Large Horseshoe Strap Kit

- Max. Door Thickness: 2-3/4"
- Max. Loading Weight: 500 lbs.

Includes:

- 2 - Horseshoe Straps
- 1 - 8' Flat Rail
- 7 - Flat Rail Mounting Brackets
- 2 - Door Stops
- 1 - Iron Heritage Handle
- All necessary fasteners

Item #	Finish
QGHPIDHP1000	Black



Heavy Duty Hook Strap Kit

- Max. Door Thickness: 2-3/4"
- Max. Loading Weight: 500 lbs.

Includes:

- 2 - Hook Straps
- 1 - 8' Flat Rail
- 7 - Flat Rail Mounting Brackets
- 2 - Door Stops
- 1 - Iron Heritage Handle
- All necessary fasteners

Item #	Finish
QGHPIDHP2000	Black



Heavy Duty Star Trolley Kit

- Max. Door Thickness: 2-1/8"
- Max. Loading Weight: 500 lbs.

Includes:

- 2 - Star Drop Trolleys
- 1 - 8' EZ-Track Channel
- 7 - EZ-Track Mounting Screws
- 2 - Door Stops
- 1 - Iron Heritage Handle
- All necessary fasteners

Item #	Finish
QGHPIDHP2000	Black



Heavy Duty Mini Horseshoe Strap Kit

- Max. Door Thickness: 2-3/4"
- Max. Loading Weight: 300 lbs.

Includes:

- 2 - Mini Horseshoe Straps
- 1 - 8' Flat Rail
- 7 - Flat Rail Mounting Brackets
- 2 - Door Stops
- 1 - Iron Heritage Handle
- All necessary fasteners

Item #	Finish
QGHPIDHP4000KS	Black



Heavy Duty Mini Hook Strap Kit

- Max. Door Thickness: 2-3/4"
- Max. Loading Weight: 300 lbs.

Includes:

- 2 - Mini Hook Straps
- 1 - 8' Flat Rail
- 7 - Flat Rail Mounting Brackets
- 2 - Door Stops
- 1 - Iron Heritage Handle
- All necessary fasteners

Item #	Finish
QGHPIDHP5000KS	Black

Iron Heritage Handle, Glossy Black

An additional glossy black handle to go along with Heavy Duty

- 2.75"W x 2.5"D x 11"H
- Weight: 2 lbs.

Item #
QGHPIDHP3009



Note: All items are non-stock. Ship direct from manufacturer.

A
B
C
D
E
F
G
H
I
J
K
L
M
N
O
P
Q
R
S
T
U
V
W
X
Y

A BARN DOOR HARDWARE

Handles, Pulls and Latches

Personalize your barn door to perfectly fit your home with our wide variety of handles, pulls, and latches! Whether you want an understated recessed pull, an elegant fleur-de-lis handle, or even a heavy duty industrial pipe handle, we have the hardware to suit your style.

Don't forget to check out our latch and strike plate set—a perfect privacy addition for bedrooms!

Hand-Forged Iron Door Handle

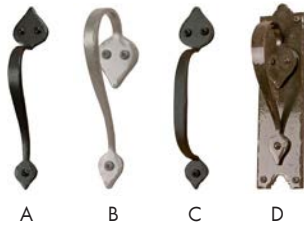

	Item #	Finish
A	QG11990102	Satin Nickel
	QG11990107	Oil Rubbed Bronze
	QG11990108	Black
B	QG11990202	Satin Nickel
	QG11990207	Oil Rubbed Bronze
	QG11990208	Black
C	QG11990209	New Age Rust
	QG11990302	Satin Nickel
	QG11990307	Oil Rubbed Bronze
D	QG11990308	Black
	QG11990309	New Age Rust
	QG11990402	Satin Nickel
D	QG11990407	Oil Rubbed Bronze
	QG11990408	Black
	QG11990409	New Age Rust

Latch & Strike Plate Set To Lock Doors



A - Traditional

B - Heavy Duty

Latch your rolling barn door from the inside. Screws are included.

	Item #	Finish
A	QG13070102	Satin Nickel
	QG13070107	Oil Rubbed Bronze
	QG13070108	Black
	QG13070109	New Age Rust
B	QGNT147901SS	Satin Nickel

Solid Brass Door Pull

Measures 6" H with 1-3/4" projection. Screws are included.



Item #	Finish
QGDAWP27U15	Satin Nickel
QGDAWP27U10B	Oil Rubbed Bronze
QGDAWP27U19	Black

Recessed Flush Pull

Ideal for use on the inside of rolling barn doors. Each pull comes with necessary screws. Use straight router bits to create a clean recess.



A - 7"

B - 4"

Item #	Finish
A - 7" x 1-7/8" x 7/16"	
QGDAFP7178U15	Satin Nickel
QGDAFP7178U10B	Oil Rubbed Bronze
QGDAFP7178U19	Black
B - 4" x 1-3/4" x 7/16"	
QGDAFP4134U15	Satin Nickel
QGDAFP4134U10B	Oil Rubbed Bronze
QGDAFP4134U19	Black

Industrial Collection Pipe Handle

Heavy duty steel with beautiful powder coat finish. Measures 13" x 3-1/2" x 3".

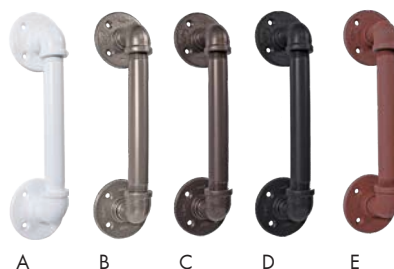

A B C D E

Laser-Cut Steel Handles

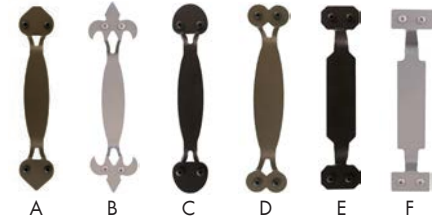

	Item #	Finish
A	QG11990502	Satin Nickel
	QG11990507	Oil Rubbed Bronze
	QG11990508	Black
	QG11990509	New Age Rust
B	QG12990102	Satin Nickel
	QG12990107	Oil Rubbed Bronze
	QG12990108	Black
C	QG12990109	New Age Rust
	QG13990102	Satin Nickel
	QG13990107	Oil Rubbed Bronze
D	QG13990108	Black
	QG13990109	New Age Rust
	QG13990202	Satin Nickel
E	QG13990207	Oil Rubbed Bronze
	QG13990208	Black
	QG13990209	New Age Rust
F	QG13990302	Satin Nickel
	QG13990307	Oil Rubbed Bronze
	QG13990308	Black
F	QG13990309	New Age Rust
	QG13990402	Satin Nickel
	QG13990407	Oil Rubbed Bronze
F	QG13990408	Black
	QG13990409	New Age Rust

	Item #	Finish
A	QG5213990101	White
B	QG5213990102	Satin Nickel
C	QG5213990107	Oil Rubbed Bronze
D	QG5213990108	Black
E	QG5213990109	New Age Rust

Note: All items are non-stock. Ship direct from manufacturer.

A
B
C
D
E
F
G
H
I
J
K
L
M
N
O
P
Q
R
S
T
U
V
W
X
Y

BARN DOORS

Pre-Assembled, Pre-Finished Barn Doors

Don't have your own door in mind to go with a set of our rolling barn door hardware? These beautiful Ponderosa Pine barn doors come pre-assembled and prefinished in four different eye-catching color and style choices, allowing you to get right to work installing it in your home right away!



These doors ship free. Better yet, if you purchase rolling door hardware along with the door, you'll receive free shipping on the hardware as well.

*Offer valid within the 48 contiguous United States. Rural or otherwise hard-to-reach areas may incur shipping charges. If this situation occurs, we will notify you before you purchase is finalized.



Trim "X" Barn Door
Fawn Stain

Item #	Door Size
QGDTX36X84FA	36"W
QGDTX42X84FA	42" W



Trim "2" Barn Door
Gray

Item #	Door Size
QGDTZ36X84GR	36"W
QGDTZ42X84GR	42" W



Trim "W" Barn Door
Mocha Stain

Item #	Door Size
QGDTW36X84MO	36"W
QGDTW42X84MO	42" W

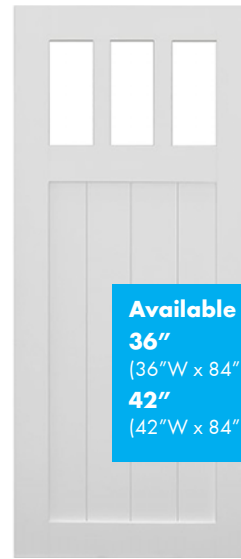

3 Window Barn Door
White

Item #	Door Size
QGD3W36X84WH	36"W
QGD3W42X84WH	42" W

Available in 2 sizes:
36"
(36"W x 84"H x 1-1/2" Thick)
42"
(42"W x 84"H x 1-1/2" Thick)

Unassembled, Unfinished Barn Door

This RTA barn door is easy to assemble and stain, and is made of beautiful ponderosa pine. A perfect match for any of our rolling door hardware kits!



Ready-to-Assemble Barn Door Kit

- Unfinished Ponderosa Pine
- Assembly screws included
- 40"W x 81"H x 1-1/2"D

Item #
QGRTA0040X81PN



After assembly – several possible styles from one kit!

Note: All items are non-stock. Ship direct from manufacturer.

- A
- B
- C
- D
- E
- F
- G
- H
- I
- J
- K
- L
- M
- N
- O**
- P
- Q
- R
- S
- T
- U
- V
- W
- X
- Y

A BARN DOOR HARDWARE



This application uses 2 Large Spoke Wheel Hook Strap Kits with 5 Bypass Door Brackets

Designer's Collection

We're excited to introduce the CSH Designer's Collection Rolling Door Kit—our newest solution for the cost-conscious buyer!

The black powder-coated steel hardware has a versatile look that is perfect for any interior space and it's sturdy enough to support a loading weight of up to 220 lbs.



Each Designer's Collection Hook Strap Kit Includes:

- 2 - Straps w/ Rollers
- 1 - Floor Center Guide
- 1 - 78 3/4" Flat Rail
- All fasteners
- 2 - Rail Stops
- 2 - Anti-Jump Blocks
- 5 - Rail Brackets

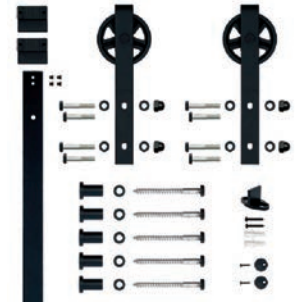

Designer's Collection 2m Kits:

2m (78-3/4") Hook Strap Kit with Large Spoke Wheels, Black

One of the most affordable rolling door kits around! You can get this steel, powder-coated black kit for your 32" or 36" door openings. For use with doors measuring between 1-3/8" and 1-3/4" thick. Maximum weight is 220 lbs.

Item #	Roller Size
QGNT140008W08	4-3/4"



2m (78-3/4") Hook Strap Kit with Small Wheels
Roller Size: 2-3/4"

Customize your door's style with one of our newest flat rail kits! For use with doors measuring between 1-3/8" and 1-3/4" thick. All major components and fasteners are finished in its corresponding color. Fits 32" and 36" openings. Maximum weight is 220 lbs.

Item #	Finish
QGNT140009W07	Oil Rub Bronze
QGNT140009W08	Black

Designer's Collection Accessories

Steel Bypass Door Bracket Buy 5 For A Complete Set

Compatible with any Designer's Collection door kit. For a complete bypass set for a Designer's Collection kit, you must purchase 5 bypass door brackets. Fasteners are included.



Item #	Finish
QGNT142308	Black

Designer's Collection Soft-Close Mechanism Kit

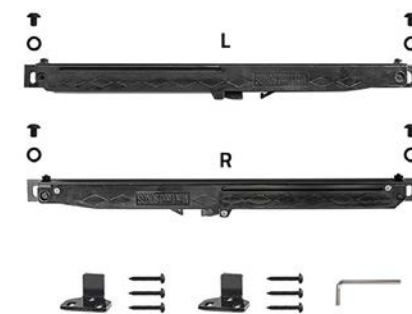

Make your door's motion extra smooth and quiet with this soft-close mechanism kit! Purchase one kit for each Designer's Collection kit.

- Includes:
- 2 - Soft-close mechanisms (L + R)
 - 2 - Actuators left and right mechanisms
 - All required fasteners.

Item #	Finish
QGNT142408	Black



Steel Flat Rail Door Stop

This steel stop comes with soft rubber linings to better adhere to the rail. Compatible with the Large Spoke Wheel kit. Sold as each. Fasteners are included.

Item #	Finish
QGNT142008	Black

Steel Flat Rail Connector Kit



Used to join flat rails together. Compatible with any Designer's Collection kit. Screws and Allen wrench are included.

Item #	Finish
QGNT141908	Black

Floor Guide for Doors with a Slotted Bottom

Item #	Finish
QGNT140308	Black Plastic
QG1303FG07	Brown Plastic



Plastic Channel

Use with the Brown Plastic Floor Guide. Protects the door from wear and tear. Trim to size.

Item #	Size
QG1313CH3607	36"
QG1313CH4807	48"

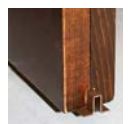

BARN DOOR HARDWARE

Stainless Steel Kits



Each Stainless Steel Round Rail Kit

- Includes:
- 2 - Straps with Rollers
 - 1 - 78-3/4" Flat Rail Segment
 - 2 - Rail-Mounted Door Stops
 - 2 - Screw-On End Caps
 - 4 - Disc Mounting Brackets
 - 1 - Floor Center Guide*
 - All necessary fasteners



Each Stainless Steel Flat Rail Kit

- Includes:
- 2 - Straps with Rollers
 - 1 - 72" or 96" Flat Rail Segment
 - 2 - Flat Rail Door Stops
 - 5 - Flat Rail Mounting Brackets
 - 2 - Anti-Jump Blocks
 - 1 - Floor Center Guide
 - All necessary fasteners

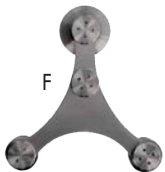
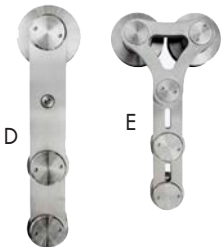
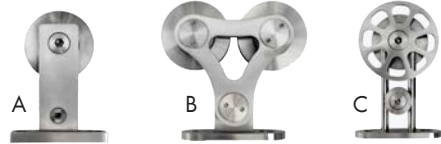

	Item #	Rail Length	Description	Max. Door Thickness	Max. Weight
Stainless Steel Round Rail Kits					
A	QGNT140001WSS	78"	Top Mount	2-5/8"	200 lb.
	QGNT140001W96SS	96"	For use with wood doors		
B	QGNT140002WSS	78"	Top Mount, Dual Wheel	2-5/8"	200 lb.
	QGNT140002W96SS	96"	For use with wood doors		
C	QGNT140004WSS	78"	Top Mount Spoke Wheel	2-5/8"	200 lb.
	QGNT140004W96SS	96"	For use with wood doors		
D	QGNT140005WGSS	78"	Front Mount Stick	1-9/16" Wood, 12mm Glass	220 lb.
	QGNT140005WG96SS	96"	For use with wood or glass doors		
E	QGNT140006WGSS	78"	Front Mount Dual Wheel	1-9/16" Wood, 12mm Glass	240 lb.
	QGNT140006WG96SS	96"	For use with wood or glass doors		
F	QGNT140007WGSS	78"	Front Mount Triangle	1-9/16" Wood, 12mm Glass	220 lb.
	QGNT140007WG96SS	96"	For use with wood or glass doors		
Stainless Steel Flat Rail Kits					
G	QGNT140003WSS	78"	Front Mount Stick	1-5/8"	220 lb.
	QGNT140003W96SS	96"	For use with wood doors		
Stainless Steel Accessories					
H	QGNT1413SS		Stainless Steel Floor Guide for wood doors		
I	QGNT1405SS		Round Rail Connector for joining round rails together-		
J	QGNT1419SS		Flat Rail Connector for joining flat rails together-		

Note: All items are non-stock.
Ship direct from manufacturer.

A
B
C
D
E
F
G
H
I
J
K
L
M
N
O
P
Q
R
S
T
U
V
W
X
Y

A BARN DOOR HARDWARE

Furniture Rolling Door Hardware

Have a great idea for a small rolling door application for an entertainment center, storage area, or decorative piece, but think our regular barn door hardware would be a little overkill? Our mini rolling door hardware is exactly what you need! It's versatile and stylish looking, and perfect for any smaller applications you can think of.

Don't forget to buy both a strap kit and a rail kit!

Each Furniture Rolling Door Hardware Kit Includes:

- 2 - Mini Straps with Rollers
- 2 - Rail End Stops
- 2 - Anti-Jump Blocks

All necessary fasteners

(kits only available in Black)

(rail kits are not included but are required)



Note: All items are non-stock. Ship direct from manufacturer.



A B C D E F G H I J

Furniture Rolling Door Hardware Kit			
	Item #	Strap Style	Size
A	QG14100108	Hook, Flat End, Black	1" W x 6.5" H
B	QG14100208	Wedge, Black	1.25" W x 6.25" H
C	QG14100308	Top Mount, Black	3" W x 2.25" H
D	QG14100408	Front Mount, Black	3" W x 3" H
E	QG14100508	Double Diamond, Black	2" W x 6.5" H
F	QG14100607	Horseshoe, (dual wheel) ORB	3.25" W x 3.5" H
	QG14100608	Horseshoe (dual wheel), Black	3.25" W x 3.5" H
G	QGNT13100108	Hook, Round End, Black	1" W x 6.5" H
H	QG14100708	Fleu-Di-Lis, Black	1.37" W x 6.87" H
I	QG14100808	Horseshoe (single wheel), Black	2.12" W x 4.37" H
J	QG14100908	Round Stick, Black	1.37" W x 6.12" H

Furniture Roller Rail Kit, Black		
Includes a steel rail (1" W x 1/8" Thick), spacers, washers, and mounting bolts.		
Item #	Rail Length	Rail Width
QGNT13024808	4'	1"
QGNT13026008	5'	1"
QGNT13027208	6'	1"

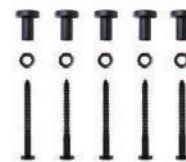

Must Be Purchased In Addition To Roller Hardware Kits



A
B
C
D
E
F
G
H
I
J
K
L
M
N
O
P
Q
R
S
T
U
V
W
X
Y

BARN DOOR HARDWARE

Barn Door Hardware Kits



- Top Mount and Face Mount Kits
- Complete, easy-to-install kits include carriers, stops, guide and all fasteners
- Aluminum round rails sold separately (below)
- All tracks, rails, and components fabricated from sleek, durable, powder-coated aluminum
- Supports doors up to 250 lbs.
- Black Finish

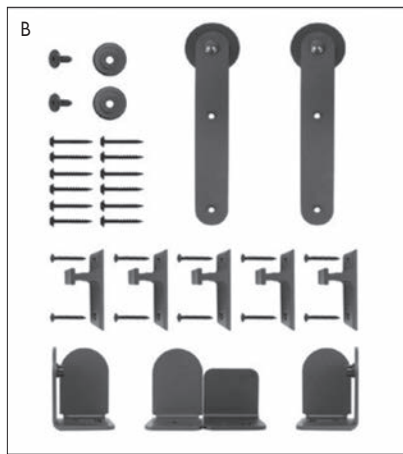
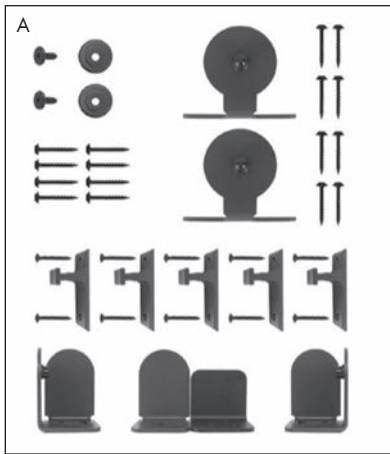

Item#	Description	Kit Includes
Barn Door Hardware Kits (Round Rail Sold Separately Below)		
A	KVRTTMBK06 Monte Carlo Series, Top Mount, Black Finish (Round Rail Sold Separately Below)	(2) Carriers, (1) Floor Guide Set, (2) Door Stops, (5) Brackets, (1) End Stop Kit & Fasteners
B	KVRTSTBK06 Macau Series, Face Mount, Black Finish (Round Rail Sold Separately Below)	(2) Carriers, (1) Floor Guide Set, (2) Door Stops, (5) Brackets, (1) End Stop Kit & Fasteners
Aluminum Round Rail		
C	KVRTBK06A	72" Aluminum Round Rail, Black Finish
	KVRTBK08A	96" Aluminum Round Rail, Black Finish

KV offers a full line of Barn Door Hardware. Wurth Baer Supply has access to the entire KV Barn Door Hardware line and can get any KV Barn Door Hardware item. Please contact Wurth Baer Supply Customer Service for more information on KV's entire line of Barn Door Hardware or shop online at www.wurthbaersupply.com → Builders Hardware → Rolling Barn Door Hardware.

- A
- B
- C
- D
- E
- F
- G
- H
- I
- J
- K
- L
- M
- N
- O
- P
- Q
- R
- S
- T
- U
- V
- W
- X
- Y

A BI-FOLD DOOR HARDWARE SET, 25 LB. CAPACITY

B
C
D
E
F
G
H
I
J
K
L
M
N
O
P
Q
R
S
T
U
V
W
X
Y



Grant Bi-fold 25 Light Duty Bi-fold Door Sets

- Up to 25 lbs. per panel
- Application: Bi-Fold Doors
- For door thickness 3/4"W up to 1-3/4"W, Top Mount, Adjustable
- Unique stay open - stay close design keeps door in place
- Spring plunger glides smoothly & easily while staying securely in place
- Doors fold flat for better access
- Floor cam functions as marking template ensuring top and bottom holes are aligned, no measuring needed
- No bottom guide assistance required
- Conforms to ANSI/BHMA standards, Grade 1



Grant Bi-fold 25 Hardware Set 2-Door 1-Way for Two Door Installation, One Way

Hardware set includes:

- (1) Pivot Plate Assembly
- (2) Plunger Spring Assembly
- (1) Floor Cam Assembly
- (1) Bi-Fold Hinge Set 2646 necessary screws installation instructions

Item#
HT1134346



Track Only, Aluminum Extruded, Pre-Drilled Holes

Screws not included - recommend #10 Flat Head

Item#	Size
HT1134406	36" Length
HT1134399	48" Length
HT1134400	60" Length
HT1134401	72" Length
HT1134402	96" Length
HT1134403	120" Length
HT1134404	144" Length
HT1134405	192" Length

BI-FOLD DOOR HARDWARE SET, 50 LB. CAPACITY

**Grant Bi-fold 50
Light Duty Bi-fold Door Sets**



- Up to 50 lbs. per panel, Multi-Fold Up to 30 lbs. per panel
- Application: Bi-Fold Doors
- For door thickness 3/4"W up to 1-3/4"W, Top Mount, Adjustable
- Unique stay open - stay close design keeps door in place
- Ball bearing carrier with 4-wheels for smooth and long lasting operation
- Doors fold flat for better access
- Simple & easy to install, floor cam functions as marking template ensuring top and bottom holes are aligned, no measuring needed
- No bottom guide assistance required
- Conforms to ANSI/BHMA standards, Grade 1

**Grant Bi-fold 50 Hardware Set 2-Door 1-Way for
Two Door Installation, One Way**

Hardware set includes:

- (1) Pivot Plate Assembly
- (1) Carrier 50E w/Quick Release Top Plate
- (1) Plunger Spring Assembly
- (1) Floor Cam Assembly
- (1) Bi-Fold Hinge Set 2646
- necessary screws
- Installation Instructions



Item#
HT1134347

Track Only, Aluminum Extruded, Pre-Drilled Holes

Screws not included - recommend #10 Flat Head



Item#	Size
HT1134406	36" Length
HT1134399	48" Length
HT1134400	60" Length
HT1134401	72" Length
HT1134402	96" Length
HT1134403	120" Length
HT1134404	144" Length
HT1134405	192" Length

Additional Parts for Multi-Fold Doors

For each additional door, it is required to buy (1) Carrier (HT1134322) and (1) Bi-Fold Hinge Set (HT1134407)

Grant Carrier 50E with Top Plate

- Four Ball Bearing Wheels
- Quick Release Top Plate
- Screws Included



Item#
HT1134322

Bi-fold Hinge Set

- Contains: Three (3) 2646 Hinges
- Steel, zinc plated, mortised
- Screws Included



Item#
HT1134322

A
B
C
D
E
F
G
H
I
J
K
L
M
N
O
P
Q
R
S
T
U
V
W
X
Y

A SLIDING DOOR HARDWARE KITS & COMPONENTS, 50 LB. CAPACITY

B
C
D
E
F
G
H
I
J
K
L
M
N
O
P
Q
R
S
T
U
V
W
X
Y

3/4" or 1-3/8" Thick By-Pass Door Hardware Kits & Components

- Hettich's 6034 Series is an economy line of medium duty by-pass door sliding hardware
- Applications include doors between rooms, closet doors, cabinets, storage walls, and partitions
- For 3/4" and 1-3/8" thick doors weighing up to 50 lbs with +/-1/8" vertical adjustment and headroom 1-1/8" min. to 1-3/8" max.
- Side mount single ball-bearing wheel carrier guarantees a smooth, quiet, long lasting performance
- Carriers have a set of mounting holes; ideal for hollow core doors
- Easy-turn cam vertical adjustment without having to remove carrier screws
- Dust free track design
- Quick door hanging by tilting pre-mounted hardware onto track profile
- Available in a complete hardware kits (3 track lengths: 48", 72" and 96") or individual components
- Made in the USA

Packing & Sold In: As shown on next page.

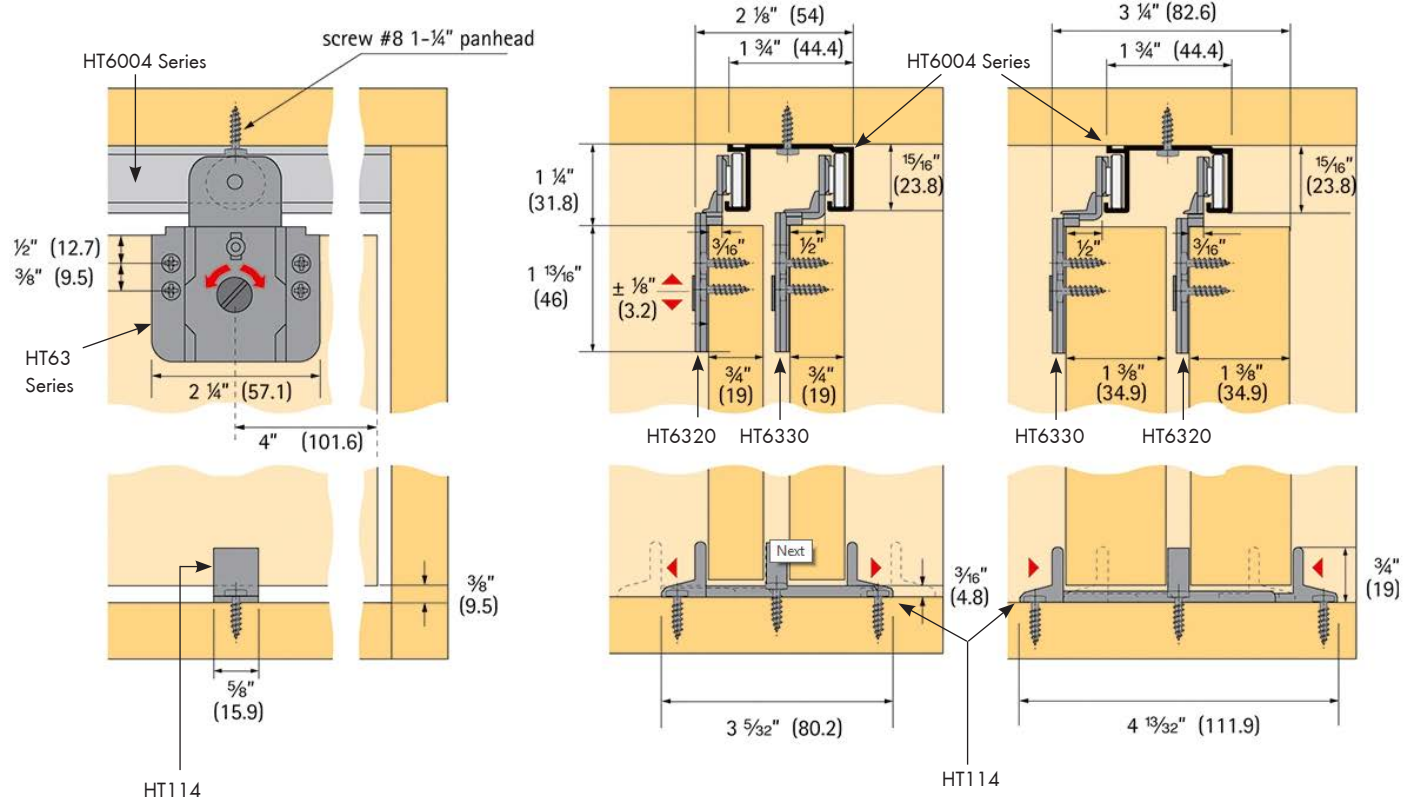
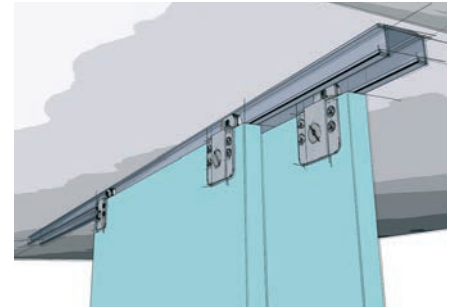

SLIDING DOOR HARDWARE KITS & COMPONENTS, 50 LB. CAPACITY

**3/4" or 1-3/8" Thick
By-Pass Door Hardware Kits**

Sliding Door Kits includes:

Aluminum Track 48", 72" and 96"L for
2 Doors:

- (2) Single Wheel Carrier (HT6320)
- (2) Single Wheel Carrier (HT6330)
- (1) Floor Guide (HT114)

Door Hardware Kit Only includes:

- (2) Single Wheel Carrier (HT6320)
- (2) Single Wheel Carrier (HT6330)
- (1) Floor Guide (HT114)
- Screws & instructions
- (Does not include Aluminum Track.)

Sliding Door Complete Kits



HT6320, 3/16" Offset
Single Wheel Carrier



HT6330, 1/2" Offset
Single Wheel Carrier



HT114,
Nylon Floor Guide



HT6004 Series, Aluminum
Double Carrier Track

Item#	Track Lengths (HT6004)
Sliding Door Kit	
HT6034-4	48" L
HT6034-6	72" L
HT6034-8	96" L
Door Hardware Kit Only	
HT6030	Track not included



**3/4" or 1-3/8" Thick
By-Pass Door Hardware
Components
(sold individually)**

A

HT6004 Series,
Aluminum Double Carrier
Track

B

HT6320, 3/16"
Offset Single
Wheel Carrier

C

HT6330, 1/2"
Offset Single
Wheel Carrier

D

HT114,
Nylon Floor Guide

	Item#	Dimensions	Component Description	Finish	Box Qty
Double Carrier Tracks, Recommend #8 x 1-1/4" Panhead Screws (Screws not included)					
A	HT6004-4	1-3/4"W x 15/16"H x 48"L	4' Long Extruded Aluminum Double Carrier Track	Aluminum	5
	HT6004-6	1-3/4"W x 15/16"H x 72"L	6' Long Extruded Aluminum Double Carrier Track	Aluminum	5
	HT6004-8	1-3/4"W x 15/16"H x 96"L	8' Long Extruded Aluminum Double Carrier Track	Aluminum	5
	HT6004-10	1-3/4"W x 15/16"H x 120"L	10' Long Extruded Aluminum Double Carrier Track	Aluminum	5
	HT6004-12	1-3/4"W x 15/16"H x 144"L	12' Long Extruded Aluminum Double Carrier Track	Aluminum	5
	HT6004-16	1-3/4"W x 15/16"H x 192"L	16' Long Extruded Aluminum Double Carrier Track	Aluminum	5
Steel Carriers – Single Wheel, Side Mounting – Includes Screws					
B	HT6320	1-13/16"W x 2-13/16"H x 2-1/4"L	3/16" Offset, Adj. Ball Bearing Nylon Wheel, w/Dual Mounting Holes	Zinc Plated	50
C	HT6330	1-13/16"W x 2-13/16"H x 2-1/4"L	1/2" Offset, Adj. Ball Bearing Nylon Wheel, w/Dual Mounting Holes	Zinc Plated	50
Nylon Floor Guide – Screws Included					
D	HT114	3-5/32" or 4-13/32"W x 1-1/8"H	Floor Guide is adjustable to fit 3/4" & 1-3/8" Thick Doors	White	50

A
B
C
D
E
F
G
H
I
J
K
L
M
N
O
P
Q
R
S
T
U
V
W
X
Y

A
B
C
D
E
F
G
H
I
J
K
L
M
N
O
P
Q
R
S
T
U
V
W
X
Y

SLIDING DOOR HARDWARE KITS & COMPONENTS, 75 LB. CAPACITY

3/4" or 1-3/8" Thick By-Pass Door Hardware Kits & Components



- Hettich's 6064 Series is an economy line of medium duty by-pass door sliding hardware
- Applications include doors between rooms, closet doors, cabinets, storage walls, and partitions
- For 3/4" and 1-3/8" thick doors weighing up to 75 lbs with +/-1/8" vertical adjustment and headroom 1-1/8" min. to 1-3/8" max.
- Side mount double ball-bearing wheel carrier guarantees a smooth, quiet, long lasting performance
- Pivoting rocker arms ensure track-carrier contact
- Carriers have dual set of mounting holes; ideal for hollow core doors
- Easy-turn cam vertical adjustment without having to remove carrier screws
- Dust free track design
- Quick door hanging by tilting pre-mounted hardware onto track profile
- Available in a complete hardware kits (with 48", 72" or 96" track lengths) or individual components

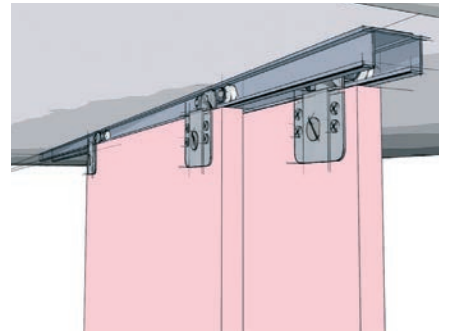

Packing & Sold In: As shown on next page.

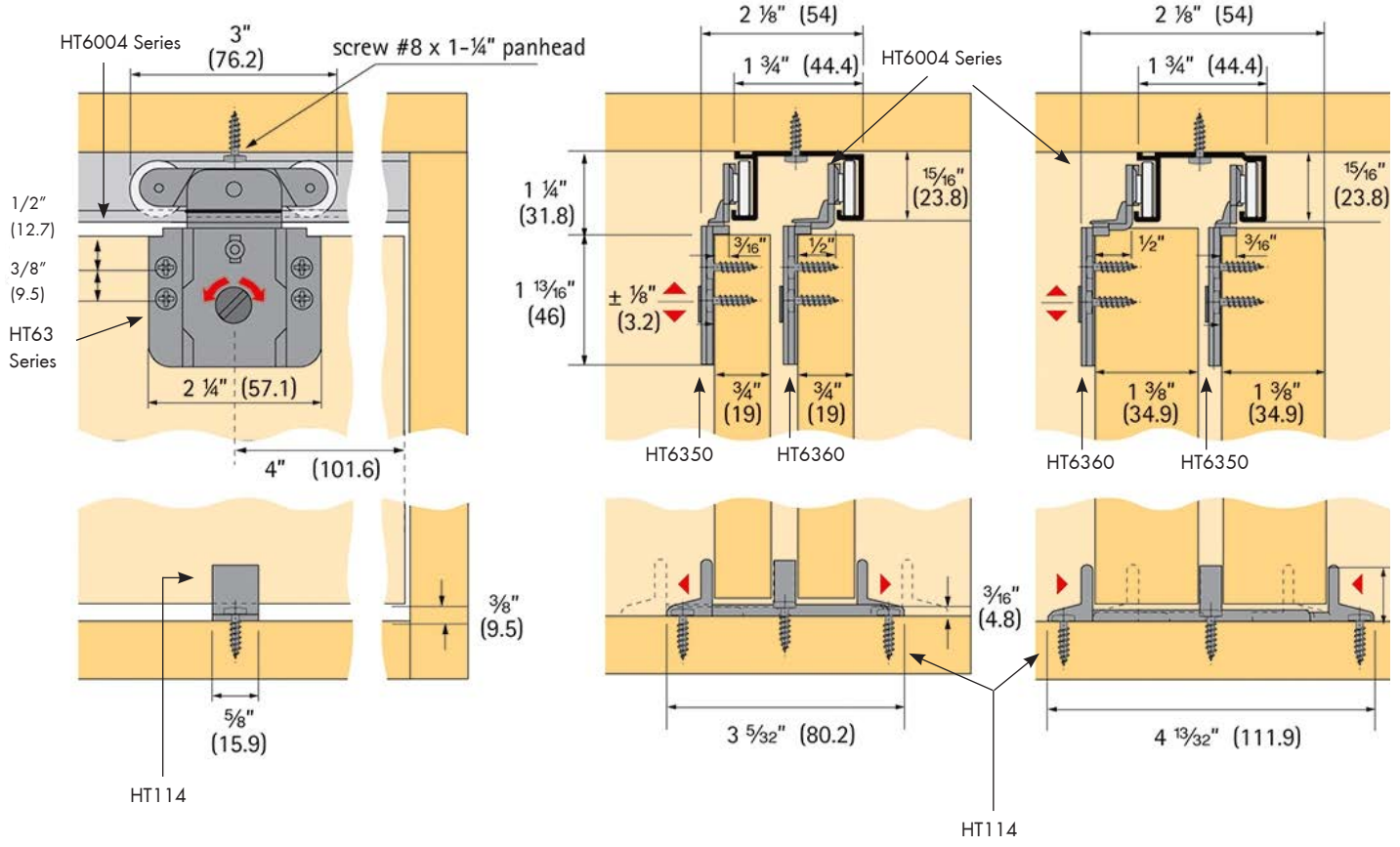

SLIDING DOOR HARDWARE KITS & COMPONENTS, 75 LB. CAPACITY

**3/4" or 1-3/8" Thick
By-Pass Door Hardware Kits**

Sliding Door Kits includes:

- Aluminum Track 48", 72" and 96"L for 2 Doors:
- (2) Single Wheel Carrier (HT6350)
- (2) Single Wheel Carrier (HT6360)
- (1) Floor Guide (HT114)

Door Hardware Kit Only includes:

- (2) Single Wheel Carrier (HT6350)
- (2) Single Wheel Carrier (HT6360)
- (1) Floor Guide (HT114)
- Screws & instructions
- (Does not include Aluminum Track.)
- Packing & Sold In: 10 kits per box.

Sliding Door Complete Kits



HT6350, 3/16" Offset Double Wheel Carrier



HT6360, 1/2" Offset Double Wheel Carrier



HT114, Nylon Floor Guide



HT6004 Series, Aluminum Double Carrier Track

Item #	Track Lengths (HT6004)
Sliding Door Kits	
HT6064-4	48" L
HT6064-6	72" L
HT6064-8	96" L

Item #	Description
Door Hardware Kit Only	
HT6060	No Track Included

**3/4" or 1-3/8" Thick
By-Pass Door Hardware
Components
(Sold Individually)**

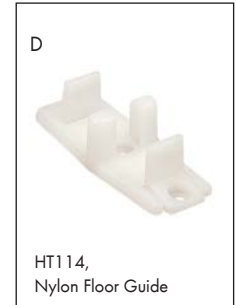

	Item#	Dimensions	Component Description	Finish	Box Qty
Double Carrier Tracks – Recommend #8 x 1-1/4" Panhead Screws (Screws not included)					
A	HT6004-4	1-3/4"W x 15/16"H x 48"L	4' Long Extruded Aluminum Double Carrier Track	Aluminum	5
	HT6064-5	1-3/4"W x 15/16"H x 60"L	5' Long Extruded Aluminum Double Carrier Track	Aluminum	10
	HT6004-6	1-3/4"W x 15/16"H x 72"L	6' Long Extruded Aluminum Double Carrier Track	Aluminum	5
	HT6004-8	1-3/4"W x 15/16"H x 96"L	8' Long Extruded Aluminum Double Carrier Track	Aluminum	5
	HT6004-10	1-3/4"W x 15/16"H x 120"L	10' Long Extruded Aluminum Double Carrier Track	Aluminum	5
	HT6004-12	1-3/4"W x 15/16"H x 144"L	12' Long Extruded Aluminum Double Carrier Track	Aluminum	5
	HT6004-16	1-3/4"W x 15/16"H x 192"L	16' Long Extruded Aluminum Double Carrier Track	Aluminum	5
Steel Carriers – Double Wheel, Side Mounting, Rocker Arms – Includes Screws					
B	HT6350	3/16"W x 2-13/16"H x 2-3/4"L	3/16" Offset , Adj. Ball Bearing Wheel, w/Dual Mounting Holes	Zinc Plated	50
C	HT6360	1/2"W x 2-13/16"H x 2-3/4"L	1/2" Offset , Adj. Ball Bearing Wheel, w/Dual Mounting Holes	Zinc Plated	50
Nylon Floor Guide – Screws Included					
D	HT114	3-5/32" or 4-13/32"W x 1-1/8"H	Floor Guide is Adjustable to fit both 3/4" and 1-3/8" Thick Doors	White	50

A
B
C
D
E
F
G
H
I
J
K
L
M
N
O
P
Q
R
S
T
U
V
W
X
Y

A SLIDING DOOR HARDWARE KITS & COMPONENTS, 150 LB. CAPACITY

B 3/4" Thick By-Pass Door Hardware Kits & Components,
C Steel Apron Mounting



- Hettich's 72-034 Series is a premium line of heavy duty by-pass door sliding hardware
- Applications include doors between rooms, closet doors, cabinets, storage walls, and partitions
- For 3/4" thick doors weighing up to 150 lbs with +/-1/8" vertical adjustment and headroom 1-7/8" minimum to 2-1/8" maximum
- Heavy duty aluminum double I-beam track with jump proof design
- Pivoting rocker arms ensure track-carrier contact
- Ball and socket suspension compensates for minor header misalignment
- Lock nut guarantees permanent positioning
- Serrations in apron permit vertical adjustment
- Side mount double ball-bearing wheel carrier guarantees a smooth, quiet, long lasting performance
- Conforms to ANSI/BHMA standards, Grade 1
- Available in a complete hardware kits (with 48", 72" or 96" long tracks) or individual components



Note: (*) Special Order

Packing & Sold In: As shown on next page.

Details on next page

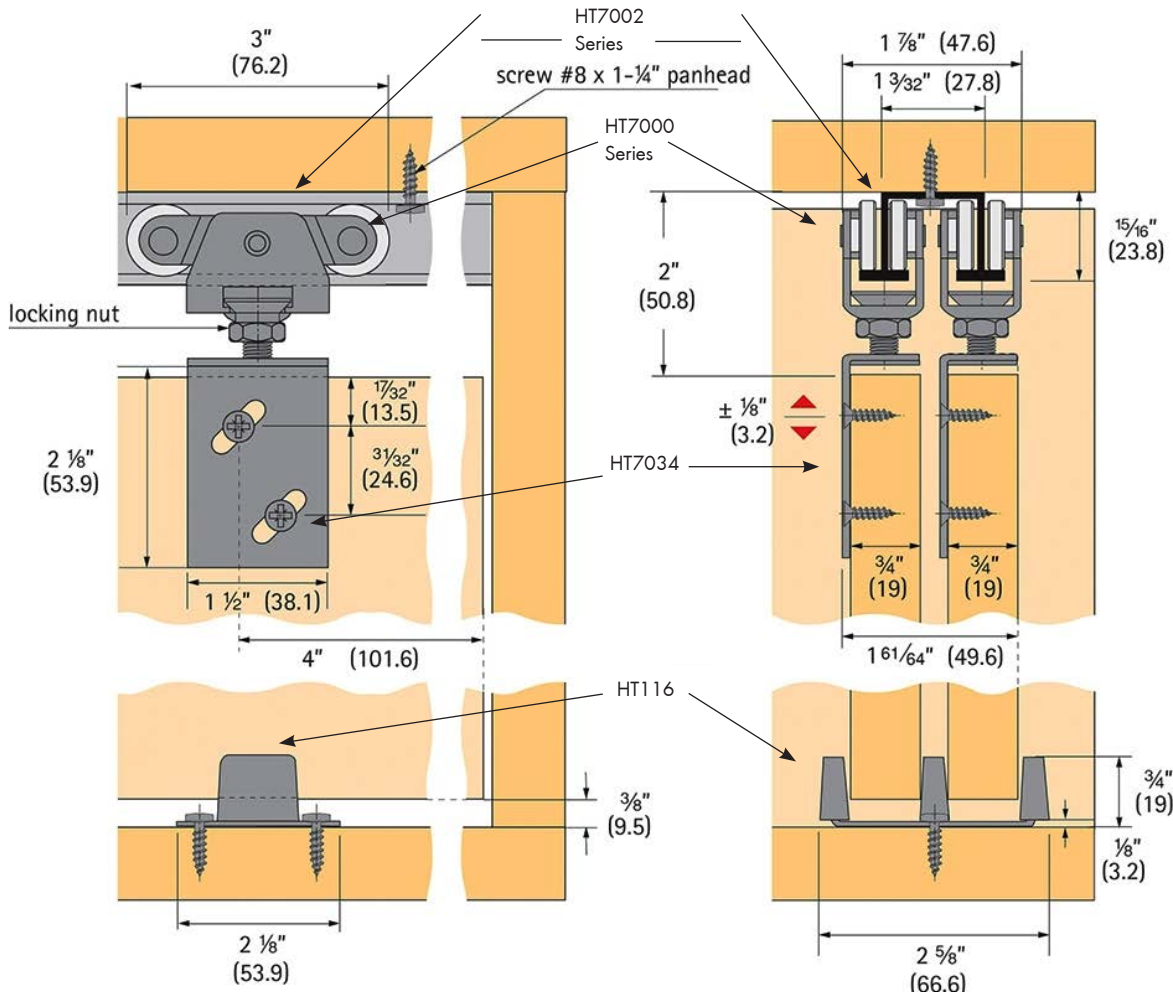

SLIDING DOOR HARDWARE, 150 LB. CAPACITY

3/4" Thick By-Pass Door Hardware Kits

Sliding Door Kits includes:

- Aluminum Track 48", 72" and 96" L for 2 Doors
- (4) Ball Bearing Carriers (HT7000-BB)
- (4) Offset Steel Apron (HT7034)
- (1) Floor Guide (HT116)



Door Hardware Kit Only includes:

- (2) Single Wheel Carrier (HT6350)
- (2) Single Wheel Carrier (HT6360)
- (1) Floor Guide (HT114)
- Includes screws & instructions
- (Does not include Aluminum Track.)
- Packing & Sold In: 10 kits per box.

Item #	Track Lengths
Sliding Door Kits	
HT72-034-4	48" L
HT72-034-6	72" L
HT72-034-8	96" L

Item #	Description
Door Hardware Kit Only	
HT72-034	No Track Included

3/4" Thick By-Pass Door Hardware Components (Sold Individually)

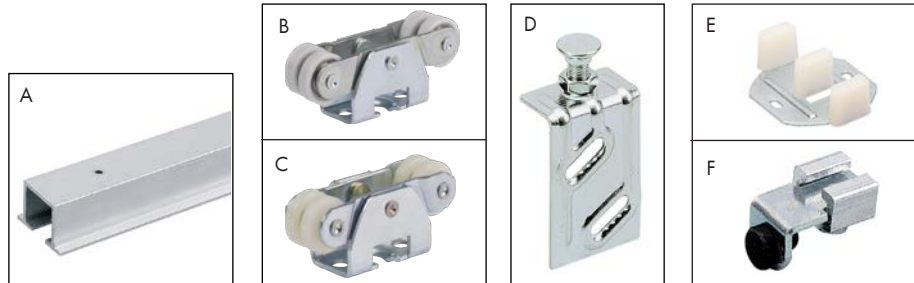

	Item#	Dimensions	Component Description	Finish	Box Qty
Double Carrier Tracks, Holes Every 11" - Recommend #8 x 1-1/4" Panhead Screws (Screws not included)					
A	HT7002-4	1-3/32"W x 15/16"H x 48"L	4' Long Extruded Aluminum Double Carrier Track	Aluminum	5
	HT7002-5	1-3/32"W x 15/16"H x 60"L	5' Long Extruded Aluminum Double Carrier Track	Aluminum	5
	HT7002-6	1-3/32"W x 15/16"H x 72"L	6' Long Extruded Aluminum Double Carrier Track	Aluminum	5
	HT7002-8	1-3/32"W x 15/16"H x 96"L	8' Long Extruded Aluminum Double Carrier Track	Aluminum	5
	HT7002-10	1-3/32"W x 15/16"H x 120"L	10' Long Extruded Aluminum Double Carrier Track	Aluminum	5
	HT7002-12	1-3/32"W x 15/16"H x 144"L	12' Long Extruded Aluminum Double Carrier Track	Aluminum	5
	HT7002-16	1-3/32"W x 15/16"H x 192"L	16' Long Extruded Aluminum Double Carrier Track	Aluminum	5
Steel Carriers - 4 Wheel					
B	HT7000-BB	1-3/16"W x 27/32"H x 2-3/4"L	(Included in sets) Ball Bearing Wheels, Up to 150 lbs/door	Zinc Plated	100
C	HT7000	1-3/16"W x 27/32"H x 2-3/4"L	(Optional) Steel, Nylon wheels, Up to 100 lbs/door	Zinc Plated	100
Steel Apron - Used to Attach Door to Carrier					
D	HT7034	1-1/2"W x 2-57/64"H x 3/4" Offset	Hole Diameter: 25/32" Diameter x 3/8" Depth	Zinc Plated	100
Steel Floor Guide - Screws Included					
E	HT116	2-5/8"W x 3/4"H x 2-1/8"L	Non-Adj. for 3/4" Doors w/Nylon covered steel uprights	Zinc Plated	50
Bumper Stop					
F	HT7014	7/8"W x 1-3/16"H x 1-19/32"L	Steel, track mounted with a rubber stop	Zinc Plated	20

A
B
C
D
E
F
G
H
I
J
K
L
M
N
O
P
Q
R
S
T
U
V
W
X
Y

A SLIDING DOOR HARDWARE, 150 LB. CAPACITY

B 1-3/8" By-Pass Thick Door Hardware Kits & Components

- Hettich's 72-138 Series is a premium line of medium duty by-pass door sliding hardware
- Applications include doors between rooms, closet doors, cabinets, storage walls, and partitions
- For 1-3/8" thick doors weighing up to 150 lbs with +/-1/8" vertical adjustment and headroom 1-7/8" minimum to 2-1/8" maximum
- Heavy duty aluminum double I-beam track has jump proof design
- Pivoting rocker arms ensure track-carrier contact
- Ball and socket suspension compensates for minor header misalignment
- Lock nut guarantees permanent positioning
- Serrations in apron permit vertical adjustment
- Side mount double ball-bearing wheel carrier guarantees a smooth, quiet and long lasting performance
- Conforms to ANSI/BHMA standards, Grade 1

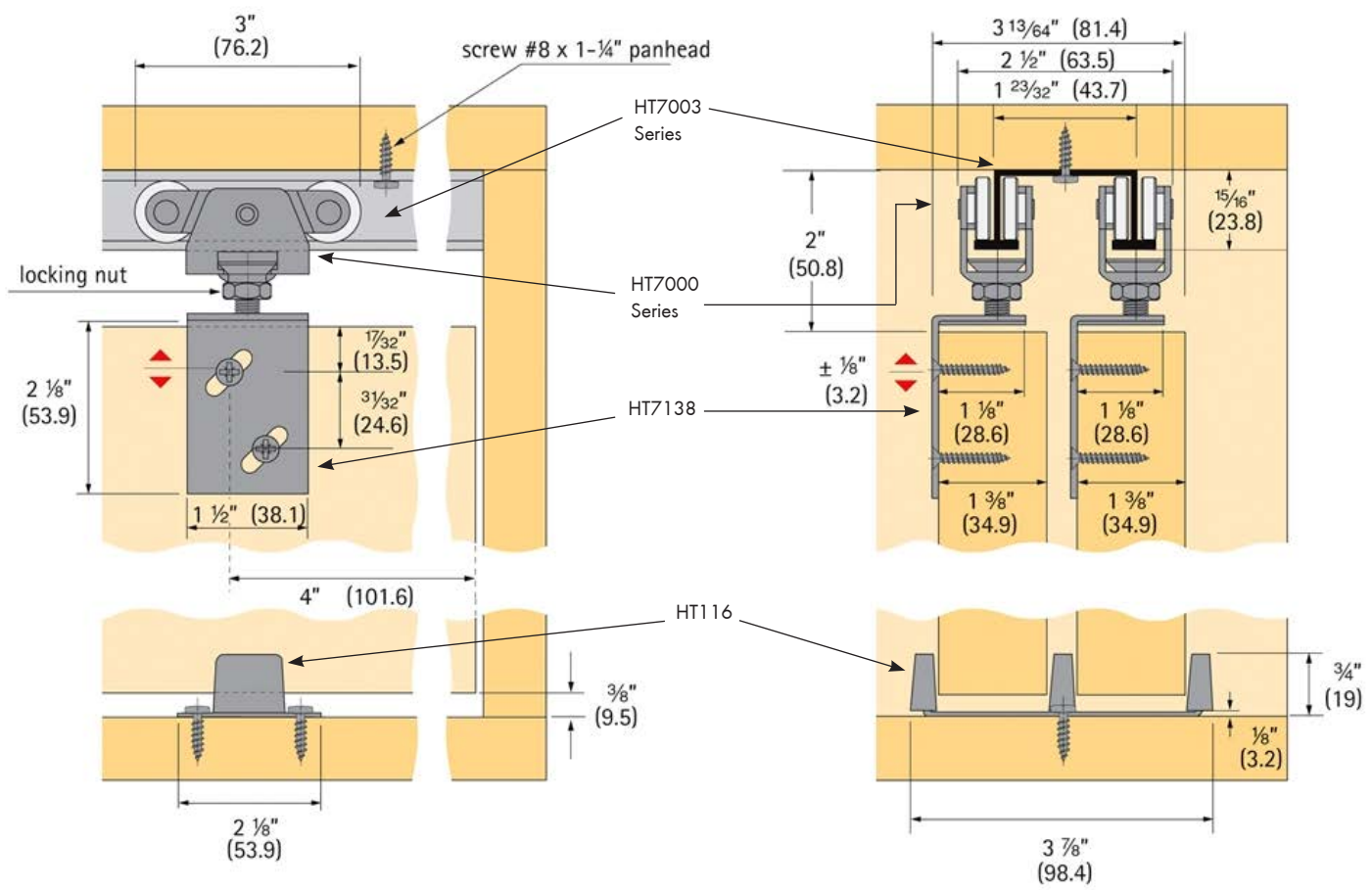
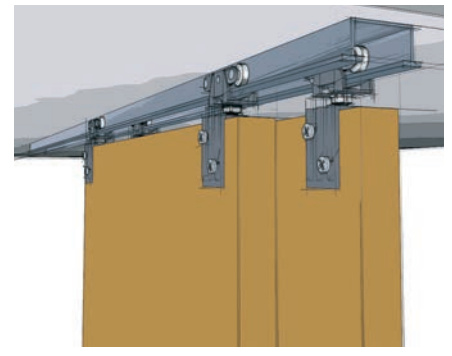

SLIDING DOOR HARDWARE, 150 LB. CAPACITY

1-3/8" Thick By-Pass Door Hardware Kits

Sliding Door Kits includes:

- Aluminum Track 48", 72" and 96"L for 2 Doors
- (4) Ball Bearing Carriers (HT7000-BB)
- (4) Offset Steel Apron (HT7034)
- (1) Floor Guide (HT116)

Door Hardware Kit Only includes:

- (4) Ball Bearing Carriers (HT7000-BB)
- (4) Offset Steel Apron (HT7034)
- (1) Floor Guide (HT116)
- Includes screws & instructions
- (Does not include Aluminum Track.)
- Packing & Sold In: 10 kits per box.

By-Pass Door Complete Kits



HT7000-BB, Ball Bearing, 4-Wheel Carrier



HT7138, 1-1/8" Offset Steel Apron



HT116, Steel Floor Guide



HT7003 Series, Aluminum Double Carrier Track

Item #	Track Lengths
Sliding Door Kits	
HT72-138-4	48" L
HT72-138-5	60" L
HT72-138-5	72" L
HT72-138-6	96" L

Item #	Description
Door Hardware Kit Only	
HT72-034	No Track Included

1-3/8" Thick By-Pass Door Hardware Components (Sold Individually)

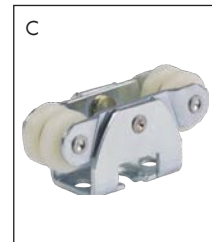
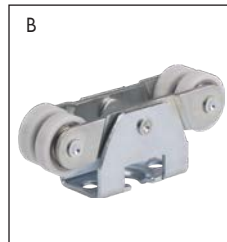
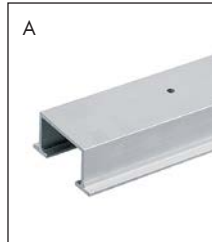

	Item#	Dimensions	Description	Finish	Box Qty
Double Carrier Tracks, Holes Every 11" - Screws not Included, Recommend #8 x 1-1/4" Panhead Screws					
A	HT7003-4	1-23/32"W x 15/16"H x 48"L	4' Long Extruded Aluminum Double Carrier Track	Aluminum	5
	HT7003-5	1-23/32"W x 15/16"H x 60"L	5' Long Extruded Aluminum Double Carrier Track	Aluminum	5
	HT7003-6	1-23/32"W x 15/16"H x 72"L	6' Long Extruded Aluminum DoubleCarrier Track	Aluminum	5
	HT7003-8	1-23/32"W x 15/16"H x 96"L	8' Long Extruded Aluminum Double Carrier Track	Aluminum	5
	HT7003-10	1-23/32"W x 15/16"H x 120"L	10' Long Extruded Aluminum Double Carrier Track	Aluminum	5
	HT7003-12	1-23/32"W x 15/16"H x 144"L	12' Long Extruded Aluminum Double Carrier Track	Aluminum	5
	HT7003-16	1-23/32"W x 15/16"H x 192"L	16' Long Extruded Aluminum Double Carrier Track	Aluminum	5
Steel Carriers – Four Wheel					
B	HT7000-BB	1-3/16"W x 27/32"H x 2-3/4"L	(Included in Sets), Ball Bearing Wheels, Up to 150 lbs/door	Zinc Plated	100
C	HT7000	1-3/16"W x 27/32"H x 2-3/4"L	(Optional), Nylon wheels, Up to 100 lbs/door	Zinc Plated	100
Steel Floor Guide – Screws Included					
D	HT116	2-5/8"W x 3/4"H x 2-1/8"L	For 3/4" Doors w/Nylon covered steel uprights	Zinc Plated	50
Bumper Stop					
E	HT7014	7/8"W x 1-3/16"H x 1-19/32"L	Steel, Track mounted with a rubber stop	Zinc Plated	20

A
B
C
D
E
F
G
H
I
J
K
L
M
N
O
P
Q
R
S
T
U
V
W
X
Y

A SLIDING DOOR HARDWARE, 150 LB. CAPACITY

B 3/4" Thick Single Door Hardware Kits & Components,
C Top Plate Mounting

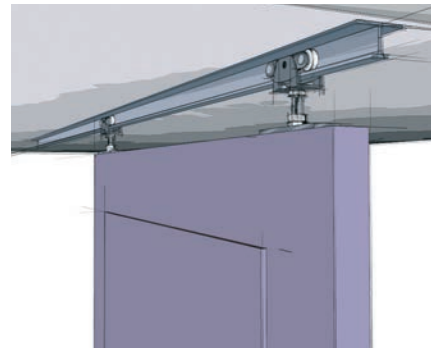

- Hettich's 71-222 Series is a premium line of heavy duty joining door sliding hardware
- Applications include doors between rooms, closet doors, cabinets, storage walls, and partitions
- For 3/4" thick doors weighing up to 150 lbs with +/-3/8" vertical adjustment and headroom 2-1/8" minimum to 2-7/8" maximum
- Heavy duty aluminum single I-beam track has jump proof design
- Pivoting rocker arms ensure track-carrier contact
- Ball and socket suspension compensates for minor header misalignment
- Lock nut guarantees permanent positioning
- Vertical adjustment + 3/8" (9.5 mm)
- Conforms to ANSI/BHMA standards, Grade 1
- Available in a complete hardware kits (with 48", 60", 72" and 96" long tracks) or individual components

Packing & Sold In: As shown on next page.

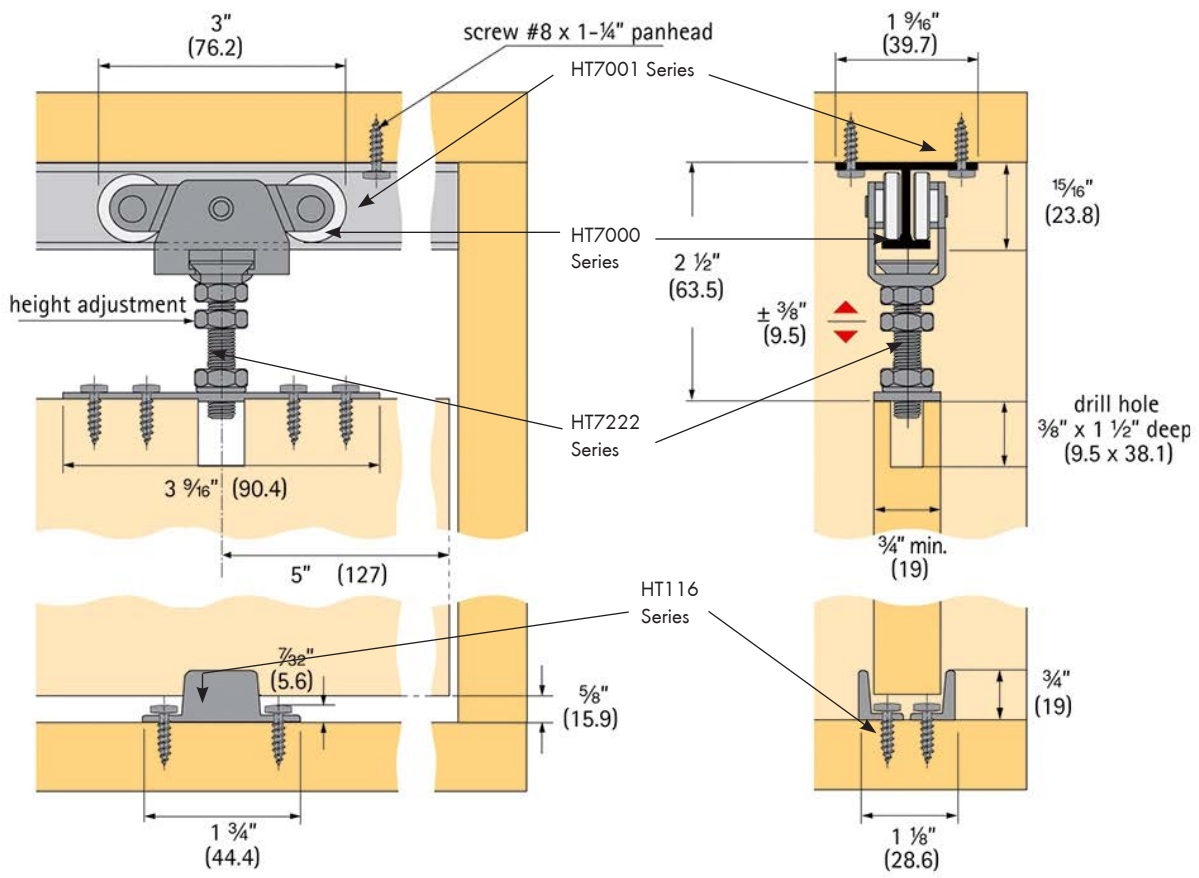

SLIDING DOOR HARDWARE, 150 LB. CAPACITY

3/4" Thick Joining Door Hardware Kits

Sliding Door Kits includes:

- Aluminum Track 48", 60" 72", 96"L for 1 Door
- (2) Ball Bearing Carriers (HT7000-BB)
- (2) Pendant Bolt Top Plates (HT222)
- (1) Steel Floor Guide (HT116)



Door Hardware Kit Only includes:

- (4) Ball Bearing Carriers (HT7000-BB)
- (4) Pendant Bolt Top Plates (HT222)
- (1) Floor Guide (HT116)

Includes screws & instructions

(Does not include Aluminum Track.)

Packing & Sold In: Complete Kits: 5 kits per box.

Door Hardware Kits: 10 kits per box

Item #	Track Lengths
Complete Sliding Door Kits	
HT71-222-4	48" L
HT71-222-5	60" L
HT71-222-6	72" L
HT71-222-8	96" L

Item #	Description
Door Hardware Kit Only	
HT71-222	No Track Included, For 2 Doors

3/4" Thick Joining Door Hardware Components (Sold Individually)

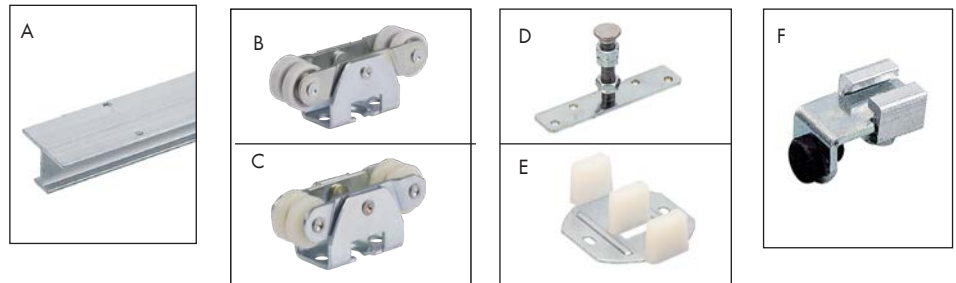

	Item#	Dimensions	Description	Finish	Box Qty
Double Carrier Tracks, Holes at Every 11" - Screws not Included, Recommend #8 x 1-1/4" Panhead Screws					
A	HT7001-4	1-3/32"W x 15/16"H x 48"L	4' Long Extruded Aluminum Double "I" Beam Track	Aluminum	5
	HT7001-5	1-3/32"W x 15/16"H x 60"L	5' Long Extruded Aluminum Double "I" Beam Track	Aluminum	5
	HT7001-6	1-3/32"W x 15/16"H x 72"L	6' Long Extruded Aluminum Double "I" Beam Track	Aluminum	5
	HT7001-8	1-3/32"W x 15/16"H x 96"L	8' Long Extruded Aluminum Double "I" Beam Track	Aluminum	5
	HT7001-10	1-3/32"W x 15/16"H x 120"L	10' Long Extruded Aluminum Double "I" Beam Track	Aluminum	5
	HT7001-12	1-3/32"W x 15/16"H x 144"L	12' Long Extruded Aluminum Double "I" Beam Track	Aluminum	5
	HT7001-16	1-3/32"W x 15/16"H x 192"L	16' Long Extruded Aluminum Double "I" Beam Track	Aluminum	5
Steel Carriers – Four Wheel					
B	HT7000-BB	1-3/16"W x 27/32"H x 2-3/4"L	(Included in sets), Ball Bearing Wheels, Up to 150 lbs/door	Zinc Plated	100
C	HT7000	1-3/16"W x 27/32"H x 2-3/4"L	(Optional), Nylon wheels, Up to 100 lbs/door	Zinc Plated	100
Steel Pendant Bolt With Top Plate – Used to Attach Door to Carrier – Screws Included					
D	HT7222	3/4"W x 1-3/4"H x 3-9/16" L	Top Plate, adjustable +/-3/8", installed on top of the door	Zinc Plated	50
Steel Floor Guide – Screws Included					
E	HT116	2-5/8"W x 3/4"H x 2-1/8"L	For 3/4" Doors w/Nylon covered steel uprights	Zinc Plated	50
Bumper Stop					
F	HT7014	7/8"W x 1-3/16"H x 1-19/32"L	Steel, track mounted with a rubber stop	Zinc Plated	20

A
B
C
D
E
F
G
H
I
J
K
L
M
N
O
P
Q
R
S
T
U
V
W
X
Y

A **ROLLING LIBRARY LADDERS**

B
C
D
E
F
G
H
I
J
K
L
M
N
O
P
Q
R
S
T
U
V
W
X
Y



Rolling Ladder Hardware Kits



Each kit includes:

- 2 Top Rollers
- 2 Bottom Wheels
- 7 Rung Support Rods (enough for 8' ladder)
- All Necessary Fasteners

Top Roller Styles:



Standard Roller
Consists of a top and bottom wheel, keeping the ladder fixed onto the rail.



Rolling Hook
Has only one wheel on the top, so the ladder can be removed easily.



Swivel Roller
Features a built-in swivel, which allows the ladder to be used on curved rails.

Finishes:



Black

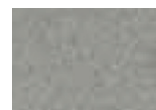

Satin Nickel

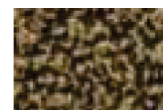

Hammered Antique Brass*



Oil Rubbed Bronze



Chrome

*Patterns may vary

Top Hook Styles:



Single Adjustable Hook
Has one hook on the top. The base is adjustable for easy storage.



Double Hook - NEW!
Cost effective alternative. The top hook is for when the ladder is in use and bottom hook is for stow-away.

Note: All items are non-stock. Ship direct from manufacturer.

ROLLING LIBRARY LADDERS

1A SELECT A TOP & BOTTOM LADDER END KIT



Standard Wheel with Standard Roller Kits

Item #	Width	Color
QG20002	16"	Satin Nickel
QG20003	16"	Hamm. Antique Brass
QG20007	16"	Oil Rubbed Bronze
QG20008	16"	Black
QG2002002	20"	Satin Nickel
QG2002003	20"	Hamm. Antique Brass
QG2002007	20"	Oil Rubbed Bronze
QG2002008	20"	Black



Contemporary Wheel with Standard Roller Kits

Item #	Width	Color
QG22002	16"	Satin Nickel
QG22003	16"	Hamm. Antique Brass
QG22007	16"	Oil Rubbed Bronze
QG22008	16"	Black
QG2202002	20"	Satin Nickel
QG2202003	20"	Hamm. Antique Brass
QG2202007	20"	Oil Rubbed Bronze
QG2202008	20"	Black



Brake Wheel with Standard Roller Kits

Item #	Width	Color
QG21002	16"	Satin Nickel
QG21003	16"	Hamm. Antique Brass
QG21004	16"	Chrome NEW!
QG21007	16"	Oil Rubbed Bronze
QG21008	16"	Black
QG2102002	20"	Satin Nickel
QG2102003	20"	Hamm. Antique Brass
QG2102004	20"	Chrome NEW!
QG2102007	20"	Oil Rubbed Bronze
QG2102008	20"	Black



Standard Wheel with Rolling Hook Kits

Item #	Width	Color
QG50002	16"	Satin Nickel
QG50003	16"	Hamm. Antique Brass
QG50007	16"	Oil Rubbed Bronze
QG50008	16"	Black
QG5002002	20"	Satin Nickel
QG5002003	20"	Hamm. Antique Brass
QG5002007	20"	Oil Rubbed Bronze
QG5002008	20"	Black



Contemporary Wheel with Rolling Hook Kits

Item #	Width	Color
QG52002	16"	Satin Nickel
QG52003	16"	Hamm. Antique Brass
QG52007	16"	Oil Rubbed Bronze
QG52008	16"	Black
QG5202002	20"	Satin Nickel
QG5202003	20"	Hamm. Antique Brass
QG5202007	20"	Oil Rubbed Bronze
QG5202008	20"	Black



Brake Wheel with Rolling Hook Kits

Item #	Width	Color
QG51002	16"	Satin Nickel
QG51003	16"	Hamm. Antique Brass
QG51004	16"	Chrome NEW!
QG51007	16"	Oil Rubbed Bronze
QG51008	16"	Black
QG5102002	20"	Satin Nickel
QG5102003	20"	Hamm. Antique Brass
QG5102004	20"	Chrome NEW!
QG5102007	20"	Oil Rubbed Bronze
QG5102008	20"	Black



Standard Wheel with Swivel Roller Kits

Item #	Width	Color
QG70002	16"	Satin Nickel
QG70003	16"	Hamm. Antique Brass
QG70007	16"	Oil Rubbed Bronze
QG70008	16"	Black
QG7002002	20"	Satin Nickel
QG7002003	20"	Hamm. Antique Brass
QG7002007	20"	Oil Rubbed Bronze
QG7002008	20"	Black



Contemporary Wheel with Swivel Roller Kits

Item #	Width	Color
QG72002	16"	Satin Nickel
QG72003	16"	Hamm. Antique Brass
QG72007	16"	Oil Rubbed Bronze
QG72008	16"	Black
QG7202002	20"	Satin Nickel
QG7202003	20"	Hamm. Antique Brass
QG7202007	20"	Oil Rubbed Bronze
QG7202008	20"	Black



Brake Wheel with Swivel Roller Kits

Item #	Width	Color
QG71002	16"	Satin Nickel
QG71003	16"	Hamm. Antique Brass
QG71007	16"	Oil Rubbed Bronze
QG71008	16"	Black
QG7102002	20"	Satin Nickel
QG7102003	20"	Hamm. Antique Brass
QG7102007	20"	Oil Rubbed Bronze
QG7102008	20"	Black

Note: All items are non-stock. Ship direct from manufacturer.

A
B
C
D
E
F
G
H
I
J
K
L
M
N
O
P
Q
R
S
T
U
V
W
X
Y

A
B
C
D
E
F
G
H
I
J
K
L
M
N
O
P
Q
R
S
T
U
V
W
X
Y

ROLLING LIBRARY LADDERS

1B OR SELECT INDIVIDUAL TOP & BOTTOM COMPONENTS



If you would prefer to choose individual ladder components instead of an entire kit, you will need to purchase individual support rods.



Standard Top Roller Guide
(Sold Individually)

The standard roller consists of top and bottom wheels, keeping your ladder fixed onto the rail. Includes all necessary hardware.

Item #	Color
QGLLTRGUIDE02	Satin Nickel
QGLLTRGUIDE03	Hamm. Antique Brass
QGLLTRGUIDE04	Chrome
QGLLTRGUIDE07	Oil Rubbed Bronze
QGLLTRGUIDE08	Black



Rolling Hook Top Guide
(Sold Individually)

The rolling hook guide has one top wheel that allows for easy rolling and easy removal. Includes installation hardware.

Item #	Color
QGLLRHGUIDE02	Satin Nickel
QGLLRHGUIDE03	Hamm. Antique Brass
QGLLRHGUIDE04	Chrome
QGLLRHGUIDE07	Oil Rubbed Bronze
QGLLRHGUIDE08	Black



Swivel Top Roller Guide
(Sold Individually)

This roller guide has a built-in swivel, allowing the ladder to glide along curved rails. Includes installation hardware.

Item #	Color
QGLLSWGUIDE02	Satin Nickel
QGLLSWGUIDE03	Hamm. Antique Brass
QGLLSWGUIDE07	Oil Rubbed Bronze
QGLLSWGUIDE08	Black



Single Adjustable Hook Top Guide
(Sold Individually)

Only compatible with the Non-Skid Foot assembly. Includes installation hardware.

Item #	Color
QGLLTHGUIDE02	Satin Nickel
QGLLTHGUIDE03	Hamm. Antique Brass
QGLLTHGUIDE07	Oil Rubbed Bronze
QGLLTHGUIDE08	Black



Double Hook Top Guide
(Sold Individually)

Only compatible with the Non-Skid Foot assembly. Includes hardware.

Item #	Color
QGLLDHGUIDE02	Satin Nickel
QGLLDHGUIDE07	Oil Rubbed Bronze
QGLLDHGUIDE08	Black



Standard Ladder Wheel Assembly
(Sold Individually)

Includes installation hardware.

Item #	Color
QGLLWHEELASSB02	Satin Nickel
QGLLWHEELASSB03	Hamm. Antique Brass
QGLLWHEELASSB07	Oil Rubbed Bronze
QGLLWHEELASSB08	Black



Contemporary Ladder Wheel Assembly
(Sold Individually)

Includes installation hardware.

Item #	Color
QGLLWHEELASSB0102	Satin Nickel
QGLLWHEELASSB0103	Hamm. Antique Brass
QGLLWHEELASSB0107	Oil Rubbed Bronze
QGLLWHEELASSB0108	Black



Brake Ladder Wheel Assembly
(Sold Individually)

Includes installation hardware.

Item #	Color
QGLLWHLASSBBK02	Satin Nickel
QGLLWHLASSBBK03	Hamm. Antique Brass
QGLLWHLASSBBK04	Chrome
QGLLWHLASSBBK07	Oil Rubbed Bronze
QGLLWHLASSBBK08	Black



Non-Skid Foot Assembly
(Sold Individually)

Compatible with any top guide. Includes installation hardware.

Item #	Color
QGLLNSFOOT02	Satin Nickel
QGLLNSFOOT07	Oil Rubbed Bronze
QGLLNSFOOT08	Black

NEW!

Non-Rolling Kits

Moveable ladder that does not roll. Comes with 7 step supports (enough for 8' ladder)



Non-Skid Foot with Single Adjustable Hook Kits

Item #	Width	Color
QG33002	16"	Satin Nickel
QG33007	16"	Oil Rubbed Bronze
QG33008	16"	Black
QG3302002	20"	Satin Nickel
QG3302007	20"	Oil Rubbed Bronze
QG3302008	20"	Black



Non-Skid Foot with Double Hook Kits

Item #	Width	Color
QG13002	16"	Satin Nickel
QG13007	16"	Oil Rubbed Bronze
QG13008	16"	Black
QG1302002	20"	Satin Nickel
QG1302007	20"	Oil Rubbed Bronze
QG1302008	20"	Black

ROLLING LIBRARY LADDERS

2 SELECT A WOOD LADDER



Standard 16" Ladder

Original Rolling Library Ladder. Great for tight spaces.

Item #	Wood Species
8' Ladder	
QG6008CH	Cherry
QG6008MA	Maple
QG6008RO	Red Oak
QG6008WA	Walnut
9' Ladder	
QG6009CH	Cherry
QG6009MA	Maple
QG6009RO	Red Oak
QG6009WA	Walnut
10' Ladder	
QG6010CH	Cherry
QG6010MA	Maple
QG6010RO	Red Oak
QG6010WA	Walnut

Standard 20" Ladder

A wider ladder for added stability, space and comfort.

Item #	Wood Species
8' Ladder	
QG600820CH	Cherry
QG600820MA	Maple
QG600820RO	Red Oak
QG600820WA	Walnut
9' Ladder	
QG600920CH	Cherry
QG600920MA	Maple
QG600920RO	Red Oak
QG600920WA	Walnut
10' Ladder	
QG601020CH	Cherry
QG601020MA	Maple
QG601020RO	Red Oak
QG601020WA	Walnut



Steam-Bent Solid Wood Hand Rails

Unfinished, sanded to 120-grit and has pre-drilled assembly holes. Sold in pairs. Specify for Black or Satin Nickel fasteners (included).

Item #	Wood Species
QG6309CH	Cherry
QG6309HC	Hickory
QG6309MA	Maple
QG6309RO	Red Oak
QG6309WA	Walnut



Additional Step Supports - for Custom Ladders and Ladders over 8'

These additional step support rods are only needed when ordering Quiet Glide ladders over 8' tall. If you're building your own ladder, use one support rod per step. Fasteners are included.

Item #	Finish	Width
QG62002	Satin Nickel	16"
QG6202002	Satin Nickel	20"
QG62004	Chrome	16"
QG6202004	Chrome	20"
QG62008	Black	16"
QG6202008	Black	20"

Note: All items are non-stock. Ship direct from manufacturer.



Top-Turned Rungs

When building your own ladder, these top-turned rungs are a nice addition. Already included with "in-stock" ladders.

Item #	Finish	Width
QG610AD	Alder	16"
QG61020AD	Alder	20"
QG610AS	Ash	16"
QG61020AS	Ash	20"
QG610CH	Cherry	16"
QG61020CH	Cherry	20"
QG610HC	Hickory	16"
QG61020HC	Hickory	20"
QG610MG	Mahogany	16"
QG61020MG	Mahogany	20"
QG610MA	Maple	16"
QG61020MA	Maple	20"
QG610PN	Pine	16"
QG61020PN	Pine	20"
QG610RO	Red Oak	16"
QG61020RO	Red Oak	20"
QG610WA	Walnut	16"
QG61020WA	Walnut	20"



Non-Skid Tread For Ladder Steps

Measures 3" x 13" with 1/4" radius corners. Should be installed after the ladder is finished.

Item #	Color
QG61	Clear

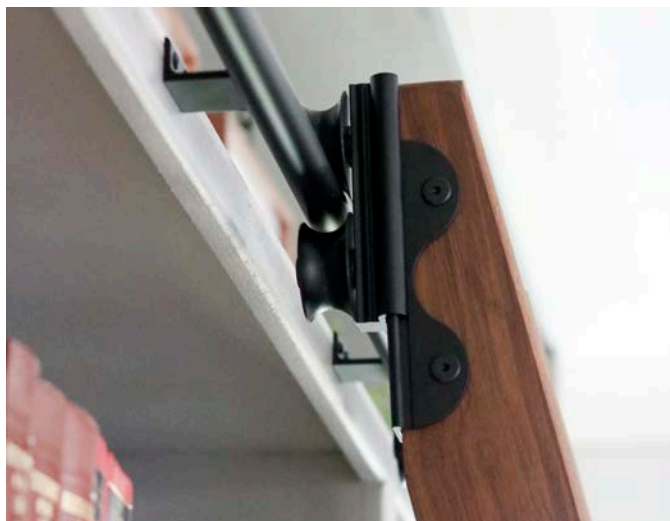

A
B
C
D
E
F
G
H
I
J
K
L
M
N
O
P
Q
R
S
T
U
V
W
X
Y

ROLLING LIBRARY LADDERS

3 SELECT RAIL COMPONENTS



Straight Rail - Three Different Lengths

Item #	Length	Finish
QG400402	4' L	Satin Nickel
QG400403	4' L	Hamm. Ant. Brass
QG400404	4' L	Chrome
QG400407	4' L	Oil Rub Bronze
QG400408	4' L	Black

Item #	Length	Finish
QG400602	6' L	Satin Nickel
QG400603	6' L	Hamm. Ant. Brass
QG400604	6' L	Chrome
QG400607	6' L	Oil Rub Bronze
QG400608	6' L	Black

Item #	Length	Finish
QG400802	8' L	Satin Nickel
QG400803	8' L	Hamm. Ant. Brass
QG400807	8' L	Oil Rub Bronze
QG400808	8' L	Black

135-Degree Curved Rail*



135° Inside Corner
30" Radius; 5' Lengths

*Not compatible with Rolling Hook hardware

Item #	Finish
QG40CRV13502	Satin Nickel
QG40CRV13503	Hamm. Ant. Brass
QG40CRV13507	Oil Rubbed Bronze
QG40CRV13508	Black

90-Degree Curved Rail*

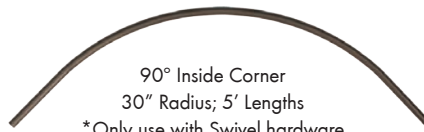

90° Inside Corner
30" Radius; 5' Lengths

*Only use with Swivel hardware

*Not compatible with Rolling Hook hardware

Item #	Finish
QG40CRV02	Satin Nickel
QG40CRV03	Hamm. Ant. Brass
QG40CRV07	Oil Rubbed Bronze
QG40CRV08	Black

90-Degree Curved Rail*

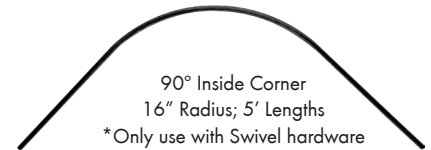

90° Inside Corner
16" Radius; 5' Lengths

*Only use with Swivel hardware

*Not compatible with Rolling Hook hardware

Item #	Finish
QG40CRV1602	Satin Nickel
QG40CRV1603	Hamm. Ant. Brass
QG40CRV1607	Oil Rubbed Bronze
QG40CRV1608	Black

Splice Kit for Joining Round Rails Together

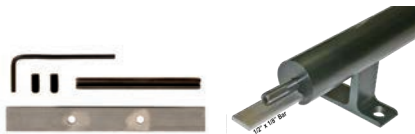

Item #	Size
QG41	1/2" x 1/8" Bar

Thread Tap Accessory

Accessory used to make threads at the end of rails for end caps.



Item #	Size
QGTAP1420	1/4" x 20 Tap

Standard End Cap Kit for Round Rails

Made out of solid steel. Each kit includes 2 caps (1-1/4" dia.) and 2 fastening bolts (1/4" #20 x 18mm)



Item #	Finish
QG4002	Satin Nickel
QG4003	Hammered Antique Brass
QG4004	Chrome
QG4007	Oil Rubbed Bronze
QG4008	Black

Ball End Cap Kit for Round Rails

Made of solid steel. Each kit includes 2 caps (1-1/4" dia.) and 2 fastening bolts (1/4" #20 x 18mm)



Item #	Finish
QG40102	Satin Nickel
QG40103*	Hammered Antique Brass
QG40107	Oil Rubbed Bronze
QG40108	Black

*Pattern may vary

End Cover Kit for Chrome Rails

Made with solid steel and plated Chrome. For use when cutting chrome rails to conceal chipping. Each kit includes 2 caps and 2 fastening bolts (1/4" #20 x 18mm)



Item #	Finish
QG40304	Chrome

Note: All items are non-stock. Ship direct from manufacturer.

ROLLING LIBRARY LADDERS

3 SELECT RAIL COMPONENTS



Wall-Mounting Bracket for Round Rails

Choose brackets, based on the top roller choice you made (in Step 1). Sold as each. Screws are included.

Vertical Rolling/Swivel Bracket

For use with Standard Top Rollers and Swivel Rollers.



Vertical Rolling Hook Bracket

For use with Rolling Hook Top Rollers.



Item #	Finish
QG20102	Satin Nickel
QG20103	Hammered Antique Brass
QG20104	Chrome
QG20107	Oil Rubbed Bronze
QG20108	Black

Item #	Finish
QG30102	Satin Nickel
QG30103	Hammered Antique Brass
QG30104	Chrome
QG30107	Oil Rubbed Bronze
QG30108	Black

Horizontal Rolling/Swivel Bracket

For use with Standard Top Rollers and Swivel Rollers.



Horizontal Rolling/Swivel Bracket

For use with Rolling Hook Top Rollers.



Item #	Finish
QG20202	Satin Nickel
QG20203	Hammered Antique Brass
QG20204	Chrome
QG20207	Oil Rubbed Bronze
QG20208	Black

Item #	Finish
QG30202	Satin Nickel
QG30203	Hammered Antique Brass
QG30204	Chrome
QG30207	Oil Rubbed Bronze
QG30208	Black

These brackets are used to mount the round rail to the wall. You will need 1 bracket for every 32" or 4 brackets for an 8' rail. Wall brackets must be mounted securely into studs.

Note: All items are non-stock.
Ship direct from manufacturer.

A
B
C
D
E
F
G
H
I
J
K
L
M
N
O
P
Q
R
S
T
U
V
W
X
Y

A SHEAVES & ROLLERS

Steel Enclosed & Open Wheel Sheaves

• Sheaves and rollers do not include screws

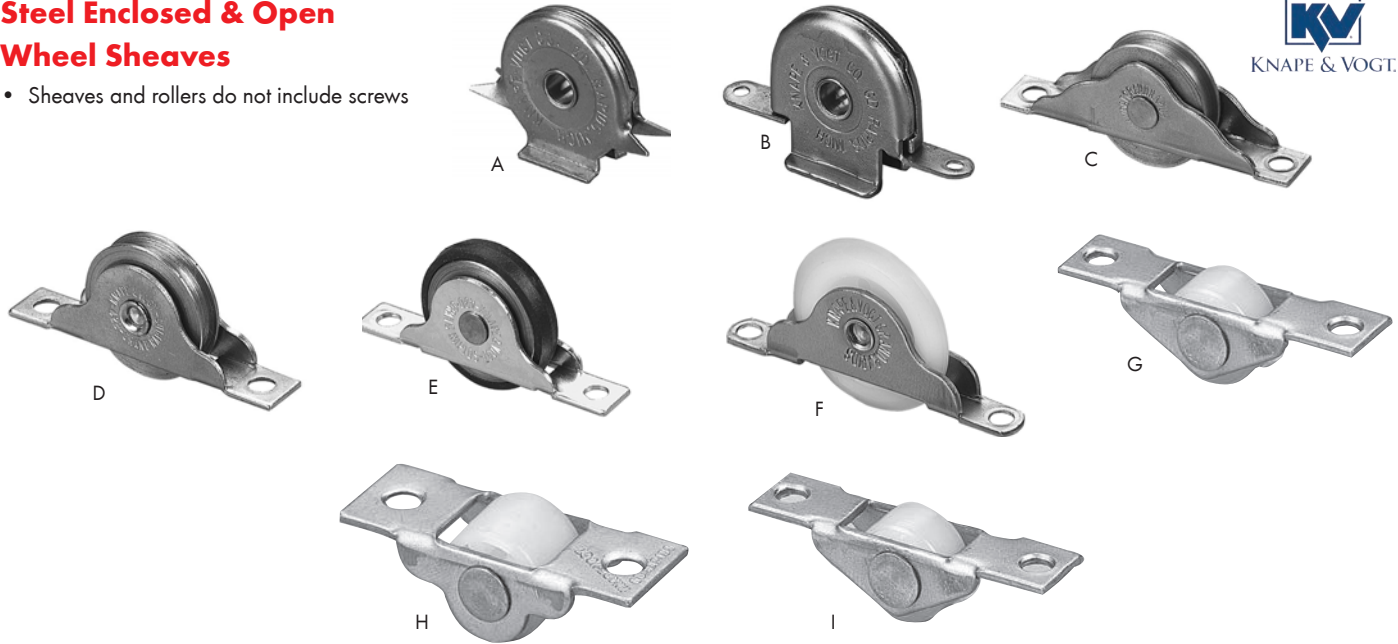

	Item#	Overall Dimensions	Description	Used with KV Steel Track#	Fasteners To Use
Enclosed Steel Sheaves (Screws Not Included)					
A	KV400A	5/16"W x 1-1/4"H x 2"L	Heavy Doors, Ball Bearing Wheel	KV455 or KV469	-
B	KV402	5/16"W x 1-1/4"H x 2-1/4"L	Heavy Doors, Ball Bearing Wheel	KV455 or KV469	#3 Flathead Wood Screws
	KV582	5/16"W x 1-1/4"H x 2-1/4"L	Light Doors, Nylon Wheel	KV455 or KV469	
Open Wheel Steel Sheaves (Screws Not Included)					
C	KV427	1/2"W x 2-15/16"H, 1-3/16"Dia. Wheel	Standard Doors, Ball Bearing Round Groove Wheel	KV455 or KV469	#6 Flathead Wood Screw
D	KV429	3/8"W x 2-1/4"H, 1"Dia. Wheel	Standard Doors, Round Groove Wheel	KV455 or KV469	#4 Flathead Wood Screw
E	KV430	1/2"W x 2-3/4"H, 1-3/8"Dia. Wheel	Standard Doors, Ball Bearing, Round Groove Wheel	KV455 or KV469	#6 Flathead Wood Screw
F	KV592	2-1/4"W x 9/32"H, 1-3/16"Dia. Wheel	Thin Doors, Nylon Convex Wheel	KV455	#3 Flathead Wood Screw
Steel Roller (Screws not included)					
G	KV420STL	7/16"W x 1-7/8"L	Nylon roller: 9/16" Dia. X 5/16" Wide	KV455 or KV469	#5 Flathead Wood Screw
H	KV422STL	5/8"W x 1-13/16"L	Nylon roller: 9/16" Dia. X 1/2" Wide	KV455 or KV469	#5 Flathead Wood Screw
I	KV423	5/8"W x 1-13/16"L	Nylon roller: 5/8" Dia. X 1/2" Wide	KV455 or KV469	#5 Flathead Wood Screw

SLIDING DOOR TRACKS

Steel Tracks/Guide

• Sold In: 1 Each



Steel Tracks & Guide					
	Item#	Overall Dimensions	Description	Fasteners Included	Finish
A	KV455-72	21/32"W x 5/16"H x 72"L	6' Single Lower Track	1/2" Nails	Steel
	KV455-144	21/32"W x 5/16"H x 144"	12' Single Lower Track	1/2" Nails	Steel
B	KV455SS-144	21/32"W x 19/64"H x 144"L	12' Single Lower Track	1/2" Nails	Stainless Steel
C	KV469-72	1"W x 1/4"H x 72"L	6' Double Lower Track	1/2" x #5 Screws	Zinc
	KV469-144	1"W x 1/4"H x 144"L	12' Double Lower Track	1/2" x #5 Screws	Zinc
D	KV953ZC-144	5/8"W x 5/8"H x 144"L	12' Top Door Divider, Upper T-Guide separates sliding door at top	-	Pre-Coated Steel



Roll-Ezy Aluminum Track System



- Designed for Small to Medium Glass Doors
- Kit Includes: (1) 1093 Upper Channel, (4) 1097 Rollers, (4) 1085 Vinyl Guides, (2) 1095 Shoes, & (1) 1099 Lower Track
- Designed for 1/4" thick glass door
- Installation Notes & Recommendations: KV does not recommend butt-joints and/or openings longer than 12 feet. KV recommends that the height to width ratio for glass doors should not exceed 2:1.
- Sold In: 1 Each Kit

Item#	Description
KVP1092ANOD-36	36" Length Small to Medium Glass Door Track Assembly Kit
KVP1092ANOD-48	48" Length Small to Medium Glass Door Track Assembly Kit
KVP1092ANOD-60	60" Length Small to Medium Glass Door Track Assembly Kit
KVP1092ANOD-72	72" Length Small to Medium Glass Door Track Assembly Kit

A
B
C
D
E
F
G
H
I
J
K
L
M
N
O
P
Q
R
S
T
U
V
W
X
Y

A
B
C
D
E
F
G
H
I
J
K
L
M
N
O
P
Q
R
S
T
U
V
W
X
Y

SLIDING GLASS DOOR DUAL TRACKS

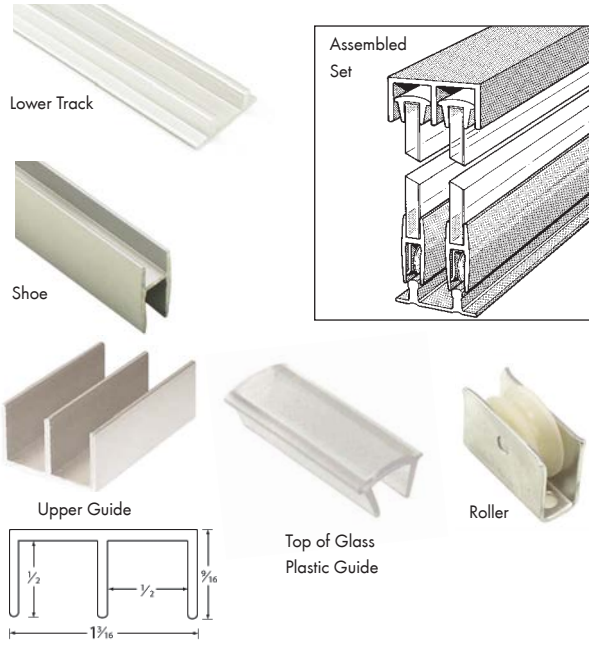

Aluminum Sliding Glass Door Dual Track Sets



- Made of aluminum with a satin clear anodized finish
- Hardware sets include: (1) Upper Guide, (4) Top of glass plastic guides, (2) Shoes, (4) Rollers & (1) Lower Track
- Corrosion free anodized aluminum members are ideal for lightweight 1/4" thick two glass door installations, plastic guides are designed to fit into the top
- Glass should be cut 1-7/32" shorter than height of opening
- Easily cut to fit any width opening
- If glass is undersized, it can be caulked for rigidity

Item #	Overall Dimensions	Finish
EP14A-3	36" Length	Aluminum
EP14A-4	48" Length	Aluminum
EP14A-5	60" Length	Aluminum
EP14A-6	72" Length	Aluminum

Large Sliding Glass Door Ball Bearing Hardware Sets & Components For By-Passing Doors, Double Tracks



- High quality ball bearing movement
- Available in hardware sets or individual components
- Hardware Set (for two glass doors) includes: (1) upper channel, (2) shoes, (2) ball bearing carriers and (1) lower track
- All hardware is made of steel with a zinc finish
- Zinc plated steel with full ball bearing carriers make this unit ideal for larger 1/4" two glass door installations
- Glass should be cut 1-1/4" shorter than height of opening, easily cut to fit any width opening
- KV does not recommend butt-joints and/or openings longer than 12 feet and that the height to length ratio for glass doors should not exceed 2:1

Item #	Length	Description	Finish
Sliding Glass Door Steel Hardware Sets			
KVP992-36	36"	(1)KV993 Upper Channel, (2)KV995 Shoe, (2)KV997 Carrier & (1)KV999 Lower Track	Zinc
KVP992-48	48"	(1)KV993 Upper Channel, (2)KV995 Shoe, (2)KV997 Carrier & (1)KV999 Lower Track	Zinc
KVP992-60	60"	(1)KV993 Upper Channel, (2)KV995 Shoe, (2)KV997 Carrier & (1)KV999 Lower Track	Zinc
KVP992-72	72"	(1)KV993 Upper Channel, (2)KV995 Shoe, (2)KV997 Carrier & (1)KV999 Lower Track	Zinc
Sliding Glass Door Steel Hardware Components			
KV993ZC-144	144"	15/16"W x 5/8"H, Upper Channel	Zinc
KV995ZC-144	144"	7/16"H, Shoe for 1/4" glass, bottom curved for free rolling position on ball bearings	Zinc
KV997ZC-144	144"	Ball Bearing Carrier has free rolling balls on 3" centers	Zinc
KV999ZC-144	144"	1"W x 1"H, Lower Track, Balls ride freely on curved anvil with no contact against sides	Zinc

SLIDING GLASS DOOR TRACKS

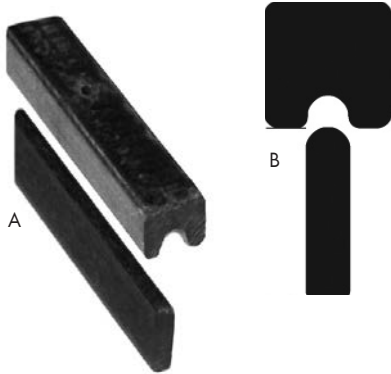

Track & Glides For Lightweight Doors

- Track and glide sold separately
- Simple installation by press-fitting the plastic track into 1/8" wide saw kerf and glides are mortised into bottom of door
- Hardened fibre tracks and glides are self-lubricating and glide smoothly
- Plastic Kerf Track sold in 100' rolls



	Item #	Overall Dimensions	Description	Color
A	EP801-6	1/8"W x 1/2"H x 72"L	Fibre Track	Gray
B	EP1801	3/8"W x 3/8"H x 1-3/8"L	Non-Locking Fibre Glide	Gray

Sliding Door Hardware Components For 3/4" Thick Doors, Dual Tracks

- Four components: Upper Guide, Lower Track, and Fibre Glides
- Upper Guide and Lower Track items are made of Aluminum and have an anodized aluminum finish
- Fibre Glides are hardened fibre with graphite composition to provide smooth operation and superb wearing qualities. No moving parts. Rust and corrosion proof.

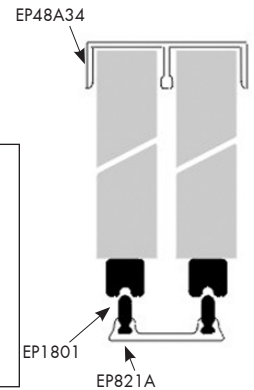
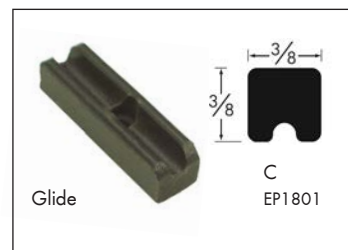
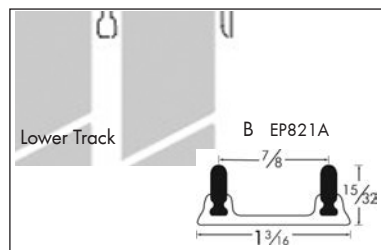
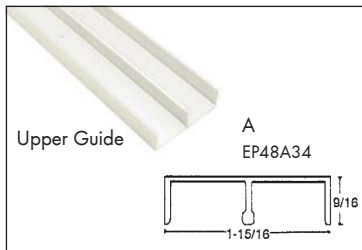

	Item#	Overall Dimensions	Channel Dimensions	Description	Finish
Upper Guide for 3/4" Thick Doors – Aluminum Material					
A	EP48A34-4	1-15/16"W x 9/16"H x 48"L	27/32"W x 1/2"D	Upper Guide, Holes at 6" Intervals	Anodized Aluminum
	EP48A34-6	1-15/16"W x 9/16"H x 72"L	27/32"W x 1/2"D	Upper Guide, Holes at 6" Intervals	Anodized Aluminum
Lower Track for 3/4" Thick Doors – Aluminum Material with Fibre Inserts					
B	EP821A-4	1-3/16"W x 15/32"H x 48"L	7/8"	Lower Track, Holes at 6" Intervals	Anodized Aluminum
	EP821A-6	1-3/16"W x 15/32"H x 72"L	7/8"	Lower Track, Holes at 6" Intervals	Anodized Aluminum
Fibre Glides					
C	EP1801	3/8"W x 3/8"H x 1-3/8"L	-	Fibre Glides = Graphite Composition	Dark Gray

A
B
C
D
E
F
G
H
I
J
K
L
M
N
O
P
Q
R
S
T
U
V
W
X
Y

A
B
C
D
E
F
G
H
I
J
K
L
M
N
O
P
Q
R
S
T
U
V
W
X
Y

SLIDING DOOR TRACKS

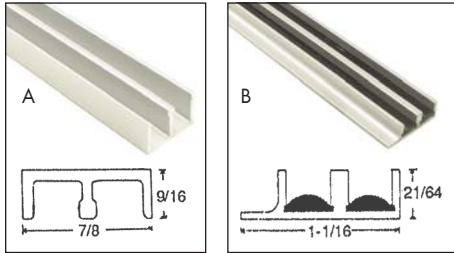

Aluminum Sliding Door Hardware Components For 1/4" Thick Doors, Dual Track



- Two components: Upper Guide Track and Lower Guide Track with built in fibre inserts
- Upper guide and lower track are made of aluminum and have an Anodized Aluminum finish
- Lower track with fibre insert is hardened fibre with graphite composition to provide smooth operation and superb wearing qualities. No moving parts. Rust and corrosion proof.
- Sliding action is always sure, easy and quiet

Item #	Overall Dimensions	Channel Dimensions	Description	Finish	
Upper Guide for 1/4" Thick Doors – Aluminum Material					
A	EP48A14-4	7/8"W x 9/16"H x 48"L	5/16"W x 1/2"D	4' Upper Guide, Holes at 6" Intervals	Anodized Alum.
	EP48A14-6	7/8"W x 9/16"H x 72"L	5/16"W x 1/2"D	6' Upper Guide, Holes at 6" Intervals	Anodized Alum.
Lower Track for 1/4" Thick Doors – Aluminum Material with Fibre Inserts					
B	EP38AS14-4	1-1/16"W x 21/64"H x 48"L	9/32W x 11/64"D	4' Lower Track, Holes at 6" Intervals	Anodized Alum.
	EP38AS14-6	1-1/16"W x 21/64"H x 72"L	9/32W x 11/64"D	6' Lower Track, Holes at 6" Intervals	Anodized Alum.

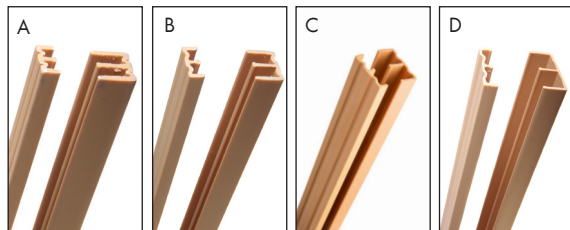

Plastic Tracks For By-Passing Doors Dual Tracks



- All tracks made of plastic, Tan color
- Set includes: matching (1) piece of upper guide and (1) piece of lower track

Item#	Upper Guide Dimensions	Lower Track Dimensions	Description	
Designed for Doors with a Thickness of 1/8"				
A	KVP2413T-48	5/8"W x 9/16"H x 48"L	5/8"W x 5/16"H x 48"L	(1)Upper Guide & (1)Lower Track
	KVP2413T-72	5/8"W x 9/16"H x 72"L	5/8"W x 5/16"H x 72"L	(1)Upper Guide & (1)Lower Track
Designed for Doors with a Thickness of 1/4"				
B	KVP2417T-48	13/16"W x 9/16"H x 48"L	13/16"W x 1/4"H x 48"L	(1)Upper Guide & (1)Lower Track
	KVP2417T-60	13/16"W x 9/16"H x 60"L	13/16"W x 1/4"H x 60"L	(1)Upper Guide & (1)Lower Track
	KVP2417T-72	13/16"W x 9/16"H x 72"L	13/16"W x 1/4"H x 72"L	(1)Upper Guide & (1)Lower Track
Designed for Doors with a Thickness of 1/2"				
C	KVP2421T-48	1-3/8"W x 1/2"H x 48"L	1-3/8"W x 5/16"H x 48"L	(1)Upper Guide & (1)Lower Track
	KVP2421T-60	1-3/8"W x 1/2"H x 60"L	1-3/8"W x 5/16"H x 60"L	(1)Upper Guide & (1)Lower Track
	KVP2421T-72	1-3/8"W x 1/2"H x 72"L	1-3/8"W x 5/16"H x 72"L	(1)Upper Guide & (1)Lower Track
Designed for Doors with a Thickness of 3/4"				
D	KVP2419T-48	1-15/16"W x 13/16"H x 48"L	1-15/16"W x 3/8"H x 48"L	(1)Upper Guide & (1)Lower Track
	KVP2419T-60	1-15/16"W x 13/16"H x 60"L	1-15/16"W x 3/8"H x 60"L	(1)Upper Guide & (1)Lower Track
	KVP2419T-72	1-15/16"W x 13/16"H x 72"L	1-15/16"W x 3/8"H x 72"L	(1)Upper Guide & (1)Lower Track

SLIDING DOOR PULLS

Sliding Door Pulls

- Economy sliding door pulls for glass and wood doors
- Packing & Sold In: As shown below.
 Sold In: Both broken and full box quantities.

IVES

EPCO

Wood Technology
 Industry Supplier of Cabinet and Furniture Hardware - Since 1928

KV
 KNAPE & VOGT



A

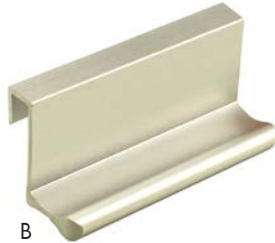

B

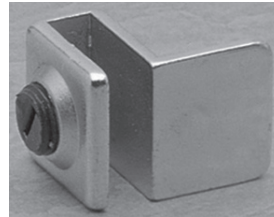

C

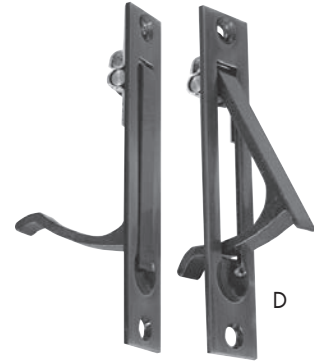

D

Item #	Overall Dimensions	Drill Hole	Material	Finish	Conforms to ANSI/BHMA	Box Qty	
Glass Door Threaded Finger Pull, Two-Piece Screw Together Pull For Glass 3/16" To 5/16" Thick							
A KV836A	1-1/16" Dia x 9/16" Deep	13/16" Dia	Zinc	Anochrome	-	50	
Glass Door Pull , Designed for 1/4" Thick Glass							
B EPGP15A	3/4" W x 1" D, 2-3/4" H	-	Aluminum	Satin Aluminum	-	25	
Glass Door Pull, Designed for 3/16" - 1/4" Thick Glass Includes Adhesive Cushion & Nylon Screw							
C	WY7020	3/4" W x 3/4" H	-	Zinc	Black	-	50
	WY7021	3/4" W x 3/4" H	-	Zinc	Bright Chrome	-	50
	WY7022	3/4" W x 3/4" H	-	Zinc	Bright Brass	-	50
Sliding Door Edge Pulls with Spring Loaded Lever for a Flush Look							
D	IV230B3	3/4" W x 1-5/8" D x 3-7/8" L	-	Brass	Bright Brass	A156.14/D2801	10
	IV230B5	3/4" W x 1-5/8" D x 3-7/8" L	-	Brass	Antique Brass	A156.14/D2801	10
	IV230B10B	3/4" W x 1-5/8" D x 3-7/8" L	-	Brass	Oil Rub Bronze	A156.14/D2801	10
	IV230B15	3/4" W x 1-5/8" D x 3-7/8" L	-	Brass	Satin Nickel	A156.14/D2801	10
	IV230B26	3/4" W x 1-5/8" D x 3-7/8" L	-	Brass	Bright Chrome	A156.14/D2801	10
Glass Door Stick-On Pull Backed with Pressure Sensitive Adhesive							
E EPGP17A	3/4" W x 2-3/4" H	-	Plastic	Aluminum	-	25	

A
B
C
D
E
F
G
H
I
J
K
L
M
N
O
P
Q
R
S
T
U
V
W
X
Y

A
B
C
D
E
F
G
H
I
J
K
L
M
N
O
P
Q
R
S
T
U
V
W
X
Y

SLIDING DOOR PULLS

Sliding Door Pulls

- Economy sliding door pulls for glass and wood doors

Packing & Sold In: As shown below.

Sold In: Both broken and full box quantities.



A



B



C



D

	Item#	Overall Dimensions	Drill Hole	Material	Finish	Conforms to ANSI/BHMA	Box Qty
Finger Pulls							
A	KVCS801XNP	31/32" Dia. X 1/4" Deep	25/36"	Metal	Nickel Plated	-	100
	KVCS803XNP	31/32" Dia. X 3/8" Deep	25/36"	Metal	Nickel Plated	-	100
Finger Pulls							
B	IV221B15	2-7/16" Dia x 7/16" Deep	2-1/8"	Brass	Satin Nickel	A156.9/B22201 A156.14/D2781	20
	IV221B26	2-7/16" Dia x 7/16" Deep	2-1/8"	Brass	Bright Chrome	A156.9/B22201 A156.14/D2781	20
	IV221B26D	2-7/16" Dia x 7/16" Deep	2-1/8"	Brass	Satin Chrome	A156.9/B22201 A156.14/D2781	20
	IV221B3	2-7/16" Dia x 7/16" Deep	2-1/8"	Brass	Bright Brass	A156.9/B22201 A156.14/D2781	20
	IV221B4	2-7/16" Dia x 7/16" Deep	2-1/8"	Brass	Satin Brass	A156.9/B22201 A156.14/D2781	20
	IV221B5	2-7/16" Dia x 7/16" Deep	2-1/8"	Brass	Antique Brass	A156.9/B22201 A156.14/D2781	20
Oval Flush Finger Pulls							
C	KVCS813ANO	3/16" x 2-7/8" x 25/64"D	51/64" x 2-1/2"	Metal	Anochrome	-	100
Flush Oblong Pulls							
D	IV22B10B	3-1/8"W x 7/16"D x 1-5/16"H	-	Brass	Oil Rubbed Bronze	A156.9/B22201 A156.14/D2781	20
	IV22B15	3-1/8"W x 7/16"D x 1-5/16"H	-	Brass	Satin Nickel	A156.9/B22201 A156.14/D2781	20
	IV22B26	3-1/8"W x 7/16"D x 1-5/16"H	-	Brass	Bright Chrome	A156.9/B22201 A156.14/D2781	20
	IV22B26D	3-1/8"W x 7/16"D x 1-5/16"H	-	Brass	Satin Chrome	A156.9/B22201 A156.14/D2781	20
	IV22B3	3-1/8"W x 7/16"D x 1-5/16"H	-	Brass	Bright Brass	A156.9/B22201 A156.14/D2781	20
	IV22B5	3-1/8"W x 7/16"D x 1-5/16"H	-	Brass	Antique Brass	A156.9/B22201 A156.14/D2781	20

WARDROBE HOOKS

Solid Brass & Aluminum Hooks

- All Ives hooks on this page are constructed of solid brass or cast aluminum that conforms to ANSI/BHMA A156.16 L13113 for brass and L33113 for aluminum
- All hooks include installation screws

Sold In: Both broken and full box quantities.

	Finish	Item#	Dimensions	Material	Box Qty
Traditional Double Prong – 3" Projection					
A	Bright Brass	IV571A3	1-1/4"W x 1-3/4"H	Aluminum	50
	Antique Brass	IV571A5	1-1/4"W x 1-3/4"H	Aluminum	20
	Bright Nickel	IV571A14	1-1/4"W x 1-3/4"H	Aluminum	20
	Aluminum	IV571A92	1-1/4"W x 1-3/4"H	Aluminum	20
	White Epoxy	IV571A-W	1-1/4"W x 1-3/4"H	Aluminum	20
	Black Epoxy	IV571A-BLK	1-1/4"W x 1-3/4"H	Aluminum	20
	Bright Brass	IV571MB3	1-1/4"W x 1-3/4"H	Solid Brass	10
	Antique Brass	IV571MB5	1-1/4"W x 1-3/4"H	Solid Brass	10
	Oil Rub Bronze	IV571MB10B	1-1/4"W x 1-3/4"H	Solid Brass	10
	Satin Nickel	IV571MB15	1-1/4"W x 1-3/4"H	Solid Brass	10
	Bright Chrome	IV571MB26	1-1/4"W x 1-3/4"H	Solid Brass	10
	Satin Chrome	IV571MB26D	1-1/4"W x 1-3/4"H	Solid Brass	10
Wide Body Double Prong – 2-1/2" Projection					
B	Bright Brass	IV405A3	7/8"W x 1-1/2"H	Aluminum	50
	Bright Nickel	IV405A14	7/8"W x 1-1/2"H	Aluminum	50
	Natural Alum.	IV405A92	7/8"W x 1-1/2"H	Aluminum	50
C-Shaped Double Prong – 3-3/4" Projection, Overall Height = 5"					
C	Bright Chrome	IV574A26	1-3/4"W x 1-5/8"H	Aluminum	15
Large Double Prong – 3-5/8" Projection, Overall Height = 5-3/4"					
D	Bright Brass	IV575A3	1-3/8"W x 2-1/4"H	Aluminum	10
	Aluminum	IV575A92	1-3/8"W x 2-1/4"H	Aluminum	10



A
Traditional
Double Prong

B
Wide Body
Double Prong



C
C-Shaped
Double Prong

D
Large
Double Prong

IVES



E
Single Prong

F
Double Prong

Finish	(E) Single Prong		(F) Double Prong	
	Aluminum 1-5/8" Projection 1-1/4"W x 1-1/4"H Item# (Box Qty)	Solid Brass 1-11/16" Projection 1-1/4"W x 1-1/4"H Item # (Box Qty)	Aluminum 1-3/32" Projection 1-3/16"W x 1-1/16"H Item # (Box Qty)	Solid Brass 1" Projection 1-1/4"W x 1-1/8"H Item # (Box Qty)
Bright Brass	IV581A3 (20)	IV581MB3 (10)	IV582A3 (20)	IV582MB3 (10)
Antique Brass	-	-	IV582A5 (50)	-
Satin Nickel	-	IV581MB15 (10)	-	IV582MB15 (10)
Bright Nickel	IV581A14 (50)	-	IV582A14 (50)	-
Bright Chrome	-	IV581MB26 (10)	-	IV582MB26 (10)
Satin Chrome	-	IV581MB26D (10)	-	IV582MB26D (10)
Aluminum	IV581A92 (20)	-	IV582A92 (20)	-
Black Epoxy	IV581A-BLK (20)	-	IV582A-BLK (20)	-
White Epoxy	-	-	IV582A-W (20)	-

A
B
C
D
E
F
G
H
I
J
K
L
M
N
O
P
Q
R
S
T
U
V
W
X
Y

A
B
C
D
E
F
G
H
I
J
K
L
M
N
O
P
Q
R
S
T
U
V
W
X
Y

WARDROBE HOOKS

Steel Collection 2.0 Hooks

Material: Zinc



Single Prong



Double Prong

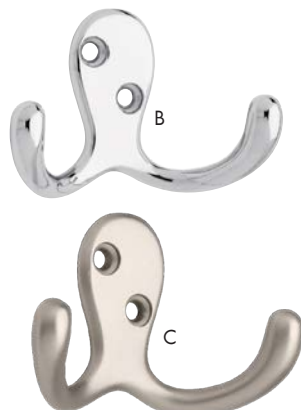

Coat Hook

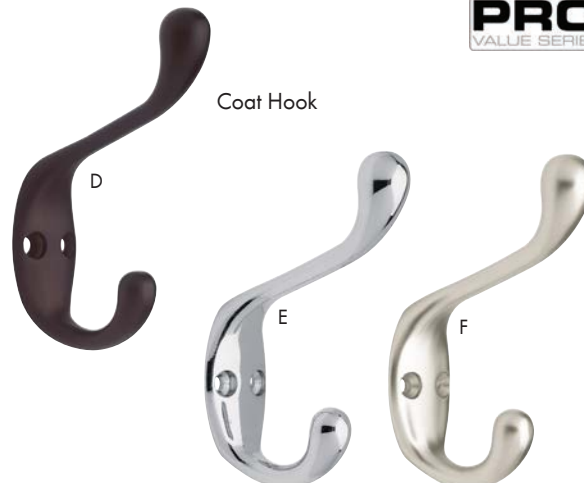

Item #	Description	Size in Inches	Finish	
A	SZSTHOOK1-PC	Single Prong Hook	.75"W x 1.875"H x 1.5"Proj	Polished Chrome
B	SZSTHOOK2-PC	Double Prong Hook	.94"BW x 1.875"H x 1"Proj, 2.75"OW	Polished Chrome
C	SZSTHOOK2-SN	Double Prong Hook	.94"BW x 1.875"H x 1"Proj, 2.75"OW	Satin Nickel
D	SZSTHOOK3-OB3	Coat Hook	.94"W x 3.625"H x 2.375"Proj	Dark Oil Rubbed Bronze
E	SZSTHOOK3-PC	Coat Hook	.94"W x 3.625"H x 2.375"Proj	Polished Chrome
F	SZSTHOOK3-SN	Coat Hook	.94"W x 3.625"H x 2.375"Proj	Satin Nickel



Zinc Wardrobe Hooks



- Includes (4) 8/32" x 1" installation screws
- Double prong hook
- Base: 1-1/16"

Item#	Dimensions	Finish
BQ8012-BPN	3/8"W x 3-1/16"H x 4"L	Brushed Nickel
BQ8013-WN	3/8"W x 3-1/16"H x 4"L	Weathered Nickel
BQ8014-55	3/8"W x 3-1/16"H x 4"L	Satin Black
BQ8015-ORB	3/8"W x 3-1/16"H x 4"L	Oil Rubbed Bronze
BQ8016-VB	3/8"W x 3-1/16"H x 4"L	Venetian Bronze

WARDROBE HOOKS

Single Prong Utility Hooks Stainless Steel



- NSF approved, utility hooks meet Food Equipment Industry Standards
- Constructed of 304 stainless steel material
- Supplied with stainless steel screws



	Overall Height	Projection	Load Capacity	Mirror Stainless Steel Item#	Polished Stainless Steel Item#
A	1-37/64"H	1-1/32"	44 lbs.	SLEL25	-
	2-9/64"H	1-17/64"	44 lbs.	SLEL30	-
B	63/64"H	63/64"	44 lbs.	SLEP25	-
	1-19/64"H	1-17/64"	44 lbs.	SLEP40	-
C	1-29/64"H	1-27/32"	22 lbs.	SLFC50	-
	1-47/64"H	2-9/16"	26 lbs.	SLFC65	-
D	25/32"H	1-7/32"	15.4 lbs.	-	SLTY30
	29/32"H	1-7/16"	15.4 lbs.	-	SLTY35
	1-1/16"H	1-23/32"	17.6 lbs.	-	SLTY40

A
B
C
D
E
F
G
H
I
J
K
L
M
N
O
P
Q
R
S
T
U
V
W
X
Y

A

WARDROBE HOOKS

B

Zinc Wardrobe Hooks

- Amerock's standard line of wardrobe hooks
- All hooks include installation screws

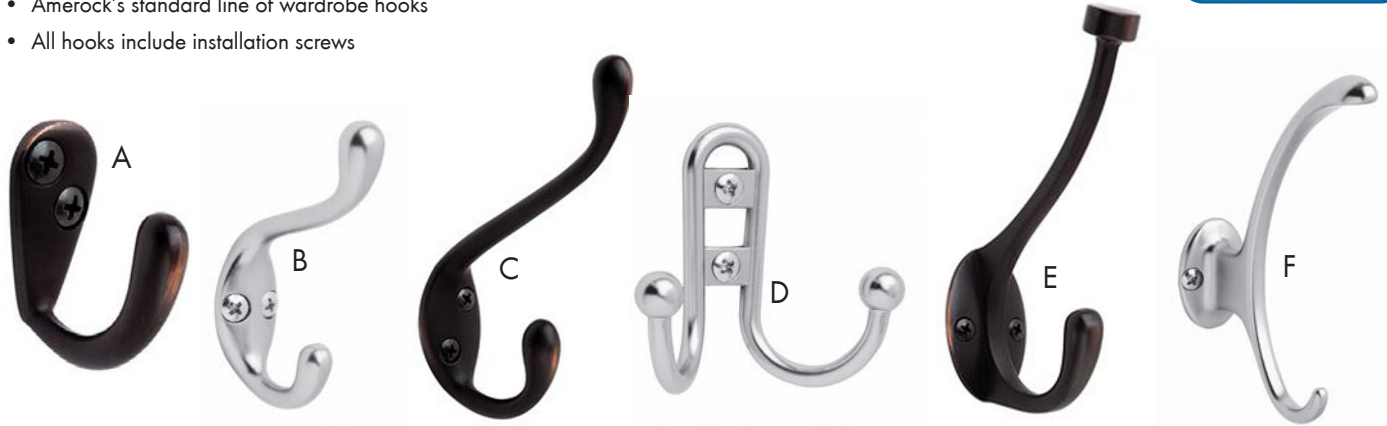

C

D

E

F

G

H

I

J

K

L

M

N

O

P

Q

R

S

T

U

V

W

X

Y

	Polished Chrome	Antique Silver	Caramel Bronze	Gilded Bronze	Satin Nickel	Silver	Oil Rubbed Bronze
Small Single Prong Hook, 1-11/16"H x 3/4"W, Projection: 1-1/2"							
A	-	-	-	-	-	-	AMH55440-ORB
Medium Coat & Hat Hook, 3-1/4"H x 13/16"W, Projection: 2-1/2"							
B	-	AMH55445-AS	AMH55445-CBZ	AMH55445-GB	AMH55445-G10	AMH55445-S	AMH55445-ORB
Large Coat & Hat Hook, 4-1/4"H x 1"W, Projection: 4"							
C	-	AMH55451-AS	AMH55451-CBZ	AMH55451-GB	AMH55451-G10	AMH55451-S	AMH55451-ORB
Double Prong Robe Hook, 2-7/8"H x 2-7/8"W, Projection: 1-1/2"							
D	AMH55457-26	AMH55457-AS	AMH55457-CBZ	AMH55457-GB	AMH55457-G10	AMH55457-S	AMH55457-ORB
Pilltop Coat & Hat Hook, 5-1/2"H x 1-1/2"W, Projection: 3-1/2"							
E	-	AMH55465-AS	-	AMH55465-GB	AMH55465-G10	AMH55465-S	AMH55465-ORB
Contemporary Coat & Hat Hook, 5"H x 1-3/16"W, Projection: 3-1/2"							
F	-	-	-	-	-	AMH55472-S	-

Zinc Over-The-Door Hooks



- All hooks include installation screws
 - Hook dimensions: 7"H x 1"W x 5-1/2"Projection
- Packing & Sold In: 4 each per box.

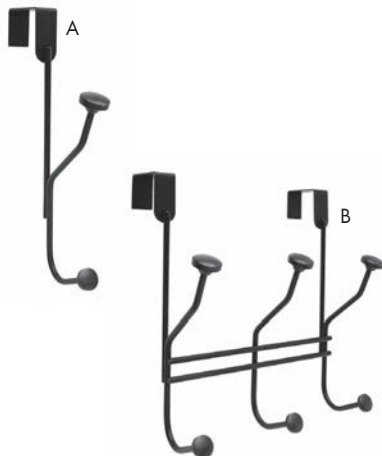

	Silver Item#	Oil Rubbed Bronze Item #	White Item #	Rack Dimensions
Single Over-The-Door Hook				
A	AMH55540-S	AMH55540-ORB	AMH55540-GW	10"H x 7/8"L
Triple Over-The-Door Hook				
B	AMH55548-S	AMH55548-ORB	AMH55548-GW	10"H x 9"L

HOOK RACKS

Zinc & Wood Hook Racks

- All hook racks include installation screws
- Packing & Sold In: As shown below.



	Hook Finish	Rack Finish	Item #	Hook Dimensions (H x W x Projection)	Rack Dimensions (H x L x Projection)	Overall Proj.	Box Qty
Four Hooks Key & Gadget Rack, 9" Length							
A	Silver	White	AMH55590-WS	7/8" x 1/2" x 1-1/4"	1-11/16" x 8-3/4" x 5/8"	1-7/8"	6
B	Silver	Mahogany	AMH55590-MS	7/8" x 1/2" x 1-1/4"	1-11/16" x 8-3/4" x 5/8"	1-7/8"	6
Three Hooks Beadboard Rack, 18" Length							
C	White/Chrome	White	AMH55640-WW26	6" x 1-7/16" x 3-1/4"	4-5/8" x 18" x 13/16"	3-7/8"	2
Four Hooks Contemporary Rack, 18" Length							
D	Silver	Mahogany	AMH55643-MS	5-1/8" x 1-1/8" x 1-1/8"	2-3/4" x 18" x 5/8"	4-1/8"	2
Four Hooks Classic Rack, 18" Length							
E	Silver	White	AMH55646-WS	3-1/2" x 13/16" x 2-3/8"	4-3/4" x 18" x 5/8"	3"	2
Three Hooks Beveled Rack, 18" Length							
F	Silver	White	AMH55656-WS	5-1/2" x 7/16" x 3-1/2"	4" x 18" x 13/16"	4-1/4"	2
Five Hooks Beveled Rack, 27" Length							
G	Silver	White	AMH55662-WS	5-1/2" x 7/16" x 3-1/2"	4" x 27" x 13/16"	4-1/4"	2

A
B
C
D
E
F
G
H
I
J
K
L
M
N
O
P
Q
R
S
T
U
V
W
X
Y

A
B
C
D
E
F
G
H
I
J
K
L
M
N
O
P
Q
R
S
T
U
V
W
X
Y

UTILITY HOOKS & HANDRAIL BRACKETS



Double Ceiling Hook

IVES

- Made of cast aluminum
- Double prong with 2-1/4" projection
- Includes installation screws

Item#	Dimensions	Finish
IV580A3	1-7/8"W x 1"H	Bright Brass
IV580A14	1-7/8"W x 1"H	Bright Nickel
IV580A92	1-7/8"W x 1"H	Aluminum

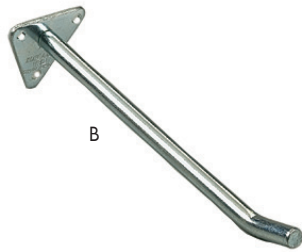
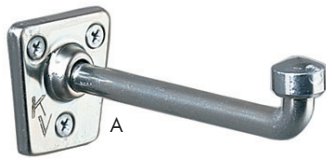

Utility Hooks, Steel

- KV's line of heavy duty steel utility hooks
- Tested and meets ANSI/ BHMA A156.9-2003
- Includes steel screws

	Item#	Dimensions	Finish
A	KVP3A-5-1/2	5-1/2" Length	Anochrome
	KVP3A-10	10" Length	Anochrome
B	KV1132A-3	3" Length	Anochrome
	KV1132A-4	4" Length	Anochrome
	KV1132A-6	6" Length	Anochrome
	KV1132A-10	10" Length	Anochrome

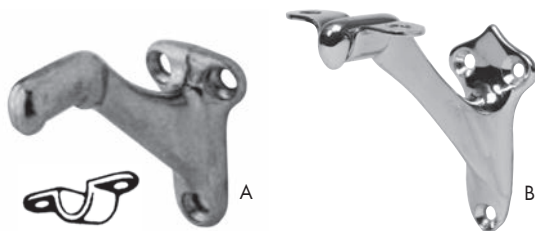

Handrail Brackets, Brass & Aluminum

IVES

- Brackets are made of solid brass and cast aluminum
- All items are supplied with screws and "U" brackets

Packing & Sold In: As shown below.

Sold In: Both broken and full box quantities.

Discount available for full box orders.

	Item#	Finish	Overall Dimensions	Wall to Center of Handrail	Material	Conforms to ANSI/ BHMA	Box Qty
Small Handrail Bracket							
A	IV059A3	Bright Brass	1-3/8"W x 2-1/4"H	2-7/16"	Aluminum	A156.16/L33061	20
	IV059A5	Antique Brass	1-3/8"W x 2-1/4"H	2-7/16"	Aluminum	A156.16/L33061	20
	IV059B15	Satin Nickel	1-3/8"W x 2-1/4"H	2-7/16"	Brass	A156.16/L13061	10
Large Handrail Bracket							
B	IV59A3	Bright Brass	1-1/2"W x 2-13/16"H	2-3/4"	Aluminum	A156.16/L33061	20
	IV59A14	Bright Nickel	1-1/2"W x 2-13/16"H	2-3/4"	Aluminum	A156.16/L33061	20
	IV59A92	Aluminum	1-1/2"W x 2-13/16"H	2-3/4"	Aluminum	A156.16/L33061	20
	IV59MB15	Satin Nickel	1-1/2"W x 2-15/16"H	2-3/4"	Brass	A156.16/L13061	10

HANDRAIL BRACKETS & SPRING HINGES



Handrail Brackets

Rakks®

- Clean, strong, and unobtrusive, the unique two-piece design reduces the cost and improves the quality of railing installation
- Heavy gauge #380 cast aluminum alloy brackets feature matching serrated surfaces that lock together eliminating slippage
- Rakks brackets meet or exceed OSHA and ADA standards
- Mount at a maximum spacing of 36 inches into studs or blocking
- 1 set includes mounting hardware (#14 Philips flat head screws and 1/4" carriage bolt and lock nut)

Item #	Size	Use For
RNHR-303	1-3/4" x 2-1/2"	4" - 7" Rail



Double Acting Gate Spring Hinges



- Double acting spring hinges enable doors to open in either direction and automatically return to a closed position
- Hinges have adjustable spring tension which allows the speed of door movement to be calibrated to size and weight of door
- Door flange of hinge is mortised into edge of door, hinge's should not be used on doors with beveled edges
- Jamb flange of hinge is surface mounted on door jamb
- All steel construction and non-handed

Item#	Finish	Max. Door Weight/Width		Door Thickness Range	Max. Door Height
		2 Hinge Set Up	3 Hinge Set Up		
3" Spring Hinges - includes #7 x 3/4" Screws					
BR3029-3-601	Black	35 lbs. / 2'-0"	39 lbs. / 2'-8"	3/4" to 1"	5'-0"
BR3029-3-603	Zinc	35 lbs. / 2'-0"	39 lbs. / 2'-8"	3/4" to 1"	5'-0"
BR3029-3-652	Dull Chrome	35 lbs. / 2'-0"	39 lbs. / 2'-8"	3/4" to 1"	5'-0"
4" Spring Hinges - includes #8 x 3/4" Screws					
BR3029-4-601	Black	60 lbs. / 2'-4"	75 lbs. / 3'-0"	7/8" to 1-1/4"	6'-8"
BR3029-4-603	Zinc	60 lbs. / 2'-4"	75 lbs. / 3'-0"	7/8" to 1-1/4"	6'-8"
BR3029-4-652	Dull Chrome	60 lbs. / 2'-4"	75 lbs. / 3'-0"	7/8" to 1-1/4"	6'-8"
6" Spring Hinges - includes #12 X 1-1/4" Screws					
BR3029-6-601	Black	75 lbs. / 2'-8"	107 lbs. / 3'-0"	1-1/4" to 1-3/4"	7'-0"
BR3029-6-603	Zinc	75 lbs. / 2'-8"	107 lbs. / 3'-0"	1-1/4" to 1-3/4"	7'-0"
BR3029-6-652	Dull Chrome	75 lbs. / 2'-8"	107 lbs. / 3'-0"	1-1/4" to 1-3/4"	7'-0"

A SPRING HINGES



Double Acting, Light Duty Gate Spring Hinge



- Made in the USA
- Conforms to ANSI K84243
- Steel material, Black finish
- Non-handed, non-adjustable tension
- Surface mounted to the gate and the jamb
- Gate hinge is supplied with (12) #7 x 3/4" wood screws

Item#	Hinge Size	Door Thickness	Max. Door Width	Min. Door Height	Max. Door Weight
BR9700-601	2-3/4"	3/4" to 1-1/8"	36"W	36"H	30 lbs.



Double Acting, Light Duty Louver Door Spring Hinge



- Designed for louver doors, does not hold door open
- Conforms to ANSI K81243
- Steel material non-handed
- Door flange is either surface mounted or mortised
- Jamb flange is surface mounted
- Includes wood screws (12) #7 x 3/4"

Finish	7/8"-1" Thick Item #	Min Door Height	Max Door Weigh/Width
Dull Zinc	BR1514-603	38"	18 lbs./18"



Single Acting Gate Spring Hinges



- Hinges have adjustable spring tension which allows the speed of the door movement to be calibrated to the door's size and weight, opens in one direction and automatically return to closed
- Conforms to ANSI Specification K81011
- Steel material non-Handed
- Pivot Points do not align with standard full mortise hinges

Item#	Finish	Max. Door Weight/ Width		Door Thickness
		2 Hinge	3 Hinge	
3" Spring Hinges, includes #7 X 3/4" Screws				
BR4010-3-652	Dull Chrome	45 lbs. / 2'-4"	65lbs. / 2'-8"	3/4"-1"
6" Spring Hinges				
BR4010-6-652	Dull Chrome	125 lbs. / 3'-0"	155lbs. / 4'-0"	1-3/4"

SCREEN DOOR & PIVOT HINGES

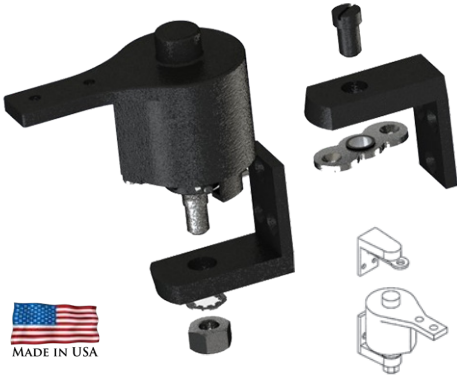

Double Acting Surface Mount Pivot Spring Hinge Kits



- Opens doors in both directions and automatically returns to the closed position
- Designed for toilet partition doors and gate doors
- Conforms to ANSI K63201
- Easily adjustable spring tension allows the hinge to be calibrated to door's size and weight
- Steel material, ball bearing, non-handed
- Doors must be at least 1" thick and door jamb at least 1-1/4" wide for hinge to adjust
- Kit Includes: (1) Pivot hinge, (1) Pivot hinge jamb & door bracket, (1) Top pivot assembly with jamb bracket, (8) #12 x 1-1/4" flat head wood screws and (2) #10 x 1" flat head wood screws

Item#	Finish	Max. Weight	Max Width	Max Thickness
BR7112-601	Black	75 lbs.	36"	2-1/2"
BR7112-603	Zinc	75 lbs.	36"	2-1/2"
BR7112-632	Bright Brass	75 lbs.	36"	2-1/2"
BR7112-633	Dull Brass	75 lbs.	36"	2-1/2"
BR7112-652	Dull Chrome	75 lbs.	36"	2-1/2"

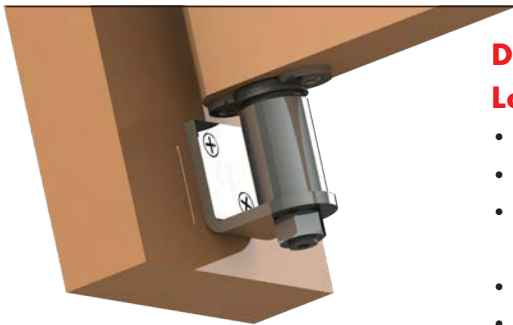

Double Acting, Gravity Pivot, Louver Hinge Kits



- No spring, weight of door allows door to close after opening
- Non-handed, Dull Chrome finish
- Pivot edge of the door will have to be rounded to 7/8" radius from the pivot center line to clear jamb
- Door jamb must be a minimum of 1-1/4" wide for hinge to operate
- Kit Includes: (1)Pivot hinge and door bracket, (1)top pivot assembly with jamb bracket and (8)#10 x 1" flat head wood screws

Item#	Kit Type	Max. Weight	Max. Width	Max. Thickness
BR7512-652	Standard Non-Hold Open	50 lbs.	30"	7/8" to 1-5/8"
BR7512H-652	Hold Open at 90°	50 lbs.	30"	7/8" to 1-5/8"



Aluminum Door Latches



- For one way swinging gates
- Reversible for either right or left hand operation
- Operated by finger pressure to underside of latch, knob has no effect on operation

Item#	Dimensions	Material	Finish
KV989AL	2-3/8"W x 2"H	Aluminum	Aluminum
KV989BR	2-3/8"W x 2"H	Aluminum	Brass

A
B
C
D
E
F
G
H
I
J
K
L
M
N
O
P
Q
R
S
T
U
V
W
X
Y

A PASSAGE DOOR HARDWARE

Door Stops

• All items are poly-bagged, screws included
 Packing: As shown below.
 Sold In: Both broken and full box quantities.

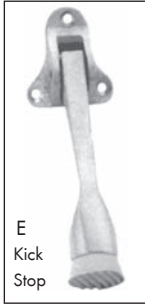

IVES

	Item#	Finish	Overall Dimensions	Projection	Mounting Type	Material	Conforms to ANSI/BHMA	Box Qty
Wall Bumper								
A	IV404B26D	Satin Chrome	1" Diameter	17/32"	Wall	Brass	-	20
	IV404B3	Bright Brass	1" Diameter	17/32"	Wall	Brass	-	20
Dome Stop – Designed For Passage Doors Without A Threshold								
B	IV436PA28	Aluminum	1-3/4" x 2" Oval	1"	Floor	Aluminum	156.6, L32141	10
Elevated Dome Stop – Designed For Passage Doors With A Threshold Or Undercut Doors								
C	IV438PA28	Aluminum	1-3/4" x 2" Oval	1-3/8"	Floor	Aluminum	156.6, L32141	10
Floor Stops – Designed For Doors With An Undercut Up To 2-1/2"								
D	IV448B3	Bright Brass	2-1/2" Diameter	3"	Floor	Brass	156.16, L12121	2
	IV448PA28	Aluminum	2-1/2" Diameter	3"	Floor	Aluminum	156.16, L32121	2
Kick Stops – Designed For Door To Floor Clearances Of 2" Or Less								
E	IV455A3	Bright Brass	1-3/4"W x 1-3/4"H	2"	Door	Aluminum	156.16, L31382	10
	IV455A92	Aluminum	1-3/4"W x 1-3/4"H	2"	Door	Aluminum	156.16, L31382	10
Flexible Wall Stops								
F	IV060F3	Bright Brass	-	3"	Wall	Steel	A156.16	20
	IV060F14	Bright Nickel	-	3"	Wall	Steel	A156.16	20
Screw-In Fixed Wall Stops								
G	IV61A3	Bright Brass	-	4"	Wall	Aluminum	-	20
	IV61A92	Aluminum	-	4"	Wall	Aluminum	-	20
	IV61MB3	Bright Brass	-	4"	Wall	Brass	-	10
	IV61MB10B	Oil Rub Bronze	-	4"	Wall	Brass	-	10
	IV61MB26	Bright Chrome	-	4"	Wall	Brass	-	10
	IV61MB26D	Satin Chrome	-	4"	Wall	Brass	-	10
Hinge Type – Door Opening Adjustments = 85° to 125°								
H	IV70A3	Bright Brass	-	-	Hinge	Aluminum	-	20
	IV70A92	Aluminum	-	-	Hinge	Aluminum	-	20

PASSAGE DOOR HARDWARE

Surface Mounted Door Bolts

- Made of brass or aluminum
- Chain Bolt type has a spring mechanism that returns the bolt into the locked position
- Spring Bolt lock can be locked with a pad lock
- Poly-bagged with screws included

Packing: As shown below.

Sold In: Both broken and full box quantities.

IVES

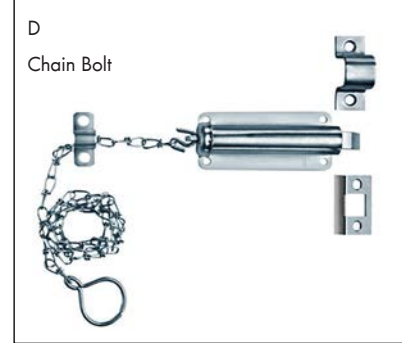
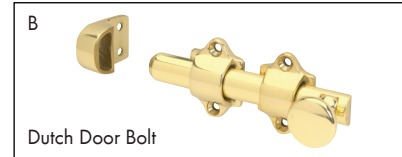
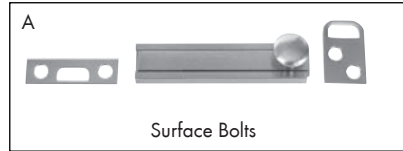

	Item#	Finish	Overall Dimensions	Bolt Throw Length	Mounting Type	Material	Box Qty
Surface Bolts – Concealed Screws							
A	IV40B10B-3	Oil Rubbed Bronze	11/16"W x 3/4"H x 3"L	3/4"	Surface	Brass	10
	IV40B15-3	Satin Nickel	11/16"W x 3/4"H x 3"L	3/4"	Surface	Brass	10
	IV40B26D-3	Satin Chrome	11/16"W x 3/4"H x 3"L	3/4"	Surface	Brass	10
	IV40B10B-4	Oil Rubbed Bronze	11/16"W x 3/4"H x 4"L	7/8"	Surface	Brass	10
	IV40B15-4	Satin Nickel	11/16"W x 3/4"H x 4"L	7/8"	Surface	Brass	10
	IV40B26D-4	Satin Chrome	11/16"W x 3/4"H x 4"L	7/8"	Surface	Brass	10
	IV40PA28-3	Polished Aluminum	11/16"W x 3/4"H x 3"L	3/4"	Surface	Aluminum	10
	IV40PA28-4	Polished Aluminum	11/16"W x 3/4"H x 4"L	7/8"	Surface	Aluminum	10
	IV40PA28-6	Polished Aluminum	11/16"W x 3/4"H x 6"L	15/16"	Surface	Aluminum	10
Dutch Door Bolt – Designed For Door To Floor Clearances Of 2" Or Less							
B	IVO54MB3	Bright Brass	1-5/8"W x 1-1/8"H x 4-3/8"L	3/4"	Surface	Brass	5
Barrel Bolt – Reversible							
C	SHN151-555	Zinc Plated	1-1/2"W x 3"L	2/3"	Surface	Steel	10
	SHN227-355-4	Zinc Plated	1-1/2"W x 4"L	15/16"	Surface	Steel	10
Chain Bolt – Includes 26" Chain							
D	EPCB-3-ZP	Zinc Plated	1-1/2"W x 3"L	1/2"	Surface	Steel	100

A
B
C
D
E
F
G
H
I
J
K
L
M
N
O
P
Q
R
S
T
U
V
W
X
Y

A PASSAGE DOOR HARDWARE

B
C
D
E
F
G
H
I
J
K
L
M
N
O
P
Q
R
S
T
U
V
W
X
Y

Mortised Door Bolts

- Bolts are made of a Cast Brass
 - Flush bolt has double action spring design that automatically holds bolt in open and closed position
 - Poly-bagged with screws included
- Packing & Sold In: 10 per box.
Sold In: Both broken and full box quantities.

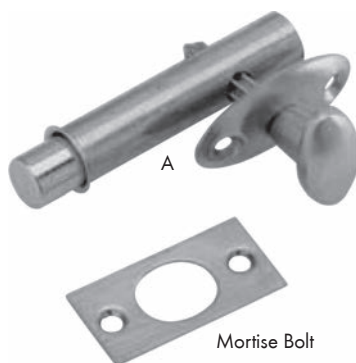

Mortise Bolt

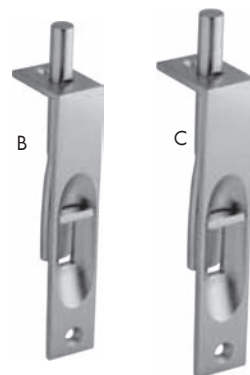

Manual Flush Bolts

IVES

	Item#	Finish	Overall Dimensions	Bolt Throw Length	Mounting Type	Material
Mortise Door Bolt						
A	IVS48B3	Bright Brass	9/16" Dia. x 2-1/2"L	1/2"	Mortise	Brass
Manual Flush Bolts – Small & Large						
B	IV261B3	Bright Brass	3/4"W x 1-1/8"D x 4"L	3/4"	Mortise	Brass
C	IV262B3	Bright Brass	3/4"W x 1-11/32"D x 6"L	1"	Mortise	Brass
	IV262B5	Antique Brass	3/4"W x 1-11/32"D x 6"L	1"	Mortise	Brass
	IV262B15	Satin Nickel	3/4"W x 1-11/32"D x 6"L	1"	Mortise	Brass
	IV262B26	Bright Chrome	3/4"W x 1-11/32"D x 6"L	1"	Mortise	Brass
	IV262B26D	Satin Chrome	3/4"W x 1-11/32"D x 6"L	1"	Mortise	Brass

Handles & Locks

- Premium line of window handles and locks
 - Made of brass and aluminum
 - Window locks and casement fasteners are designed to be weather-tight fastening and security
 - All items are supplied with screws
- Packing: As shown below.
Sold In: Both broken and full box quantities.



A



B

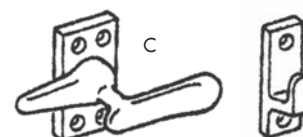

Casement Fasteners & Strike

IVES

	Item#	Finish	Overall Dimensions	Projection	Material	Conforms to ANSI/BHMA	Box Qty
Handles							
A	IV026A3	Bright Brass	4"W x 1-1/8"H	1-1/16"	Aluminum	A156.16	20
	IV026A92	Aluminum	4"W x 1-1/8"H	1-1/16"	Aluminum	A156.16	20
	IV026MB3	Bright Brass	4"W x 1-1/8"H	1-1/16"	Brass	A156.16	20
Window Lock – Crescent Type							
B	IV07A3	Bright Brass	2-9/16"W x 15/16"H	-	Aluminum	156.16	20
	IV07MB3	Bright Brass	2-9/16"W x 15/16"H	-	Brass	156.16	10
Casement Fastener – Includes Surface Strikes							
C	IV066A3SS	Bright Brass	7/8"W x 1-5/8"H	1-3/8"	Aluminum	A156.16	10
	IV066B26DSS	Satin Chrome	7/8"W x 1-5/8"H	1-3/8"	Brass	A156.16	10

BATH HARDWARE

Markham™

• Material: Zinc



	Item#	Center to Center	Overall Length	Proj.	Description	Finish
A	AMBH26510-ORB	-	5-7/8"	3"	Markham™ Tissue Roll Holder	Oil Rubbed Bronze
	AMBH26510-PN	-	5-7/8"	3"	Markham™ Tissue Roll Holder	Polished Nickel
B	AMBH26511-ORB	-	6-7/8"	3"	Markham™ Towel Ring	Oil Rubbed Bronze
	AMBH26511-PN	-	6-7/8"	3"	Markham™ Towel Ring	Polished Nickel
C	AMBH26512-ORB	-	3-1/4"	2-1/4"	Markham™ Robe Hook	Oil Rubbed Bronze
	AMBH26512-PN	-	3-1/4"	2-1/4"	Markham™ Robe Hook	Polished Nickel
D	AMBH26513-ORB	18"	20-1/3"	3"	Markham™ Towel Bar, 18"	Oil Rubbed Bronze
	AMBH26513-PN	18"	20-1/3"	3"	Markham™ Towel Bar, 18"	Polished Nickel
E	AMBH26514-ORB	24"	26-1/3"	3"	Markham™ Towel Bar, 24"	Oil Rubbed Bronze
	AMBH26514-PN	24"	26-1/3"	3"	Markham™ Towel Bar, 24"	Polished Nickel
F	AMBH26517-ORB	-	2-1/3"	3-1/4"	Tissue Roll Holder, Pivoting Double Post	Oil Rubbed Bronze
	AMBH26517-PN	-	2-1/3"	3-1/4"	Tissue Roll Holder, Pivoting Double Post	Polished Nickel

A
B
C
D
E
F
G
H
I
J
K
L
M
N
O
P
Q
R
S
T
U
V
W
X
Y

A
B
C
D
E
F
G
H
I
J
K
L
M
N
O
P
Q
R
S
T
U
V
W
X
Y

BATH HARDWARE

Clarendon™

• Material: Zinc

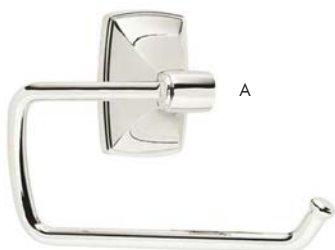

Tissue Roll Holder

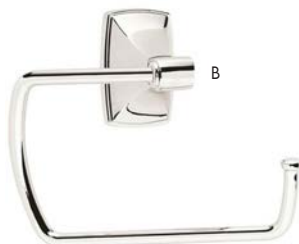

Towel Ring



Robe Hook



18" Towel Bar



24" Towel Bar



Pivoting Double Post Tissue Roll Holder



	Polished Chrome Finish	Antique Silver Finish	Satin Nickel Finish	Gilded Bronze Finish	Oil Rubbed Bronze Finish	Ctr to Ctr	Overall Length	Proj.
Tissue Roll Holder								
A	AMBH26500-26	AMBH26500-AS	AMBH26500-G10	AMBH26500-GB	AMBH26500-ORB	-	6-1/4"	3"
Towel Ring								
B	AMBH26501-26	AMBH26501-AS	AMBH26501-G10	AMBH26501-GB	AMBH26501-ORB	-	6-7/8"	3"
Robe Hook								
C	AMBH26502-26	AMBH26502-AS	AMBH26502-G10	AMBH26502-GB	AMBH26502-ORB	-	1-3/4"	3"
Towel Bar, 18"								
D	AMBH26503-26	AMBH26503-AS	AMBH26503-G10	AMBH26503-GB	AMBH26503-ORB	18"	19-3/4"	3"
Towel Bar, 24"								
E	AMBH26504-26	AMBH26504-AS	AMBH26504-G10	AMBH26504-GB	AMBH26504-ORB	24"	25-3/4"	3"
Double Towel Bar, 24"								
F	AMBH26505-26	AMBH26505-AS	AMBH26505-G10	AMBH26505-GB	AMBH26505-ORB	24"	25-3/4"	5-1/3"
Tissue Roll Holder, Pivoting Double Post								
G	AMBH26507-26	AMBH26507-AS	AMBH26507-G10	AMBH26507-GB	AMBH26507-ORB	-	2-7/8"	3"

BATH HARDWARE

Arrondi™

• Material: Stainless Steel

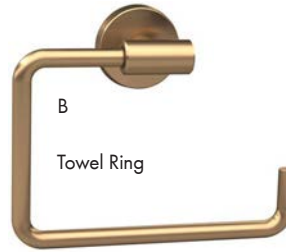

	Golden Champagne Item #	Matte Black Item #	Polished Stainless Steel Item #	Stainless Steel Item #	Description	Ctr to Ctr	Overall Length	Proj.
A	AMBH26540-BBZ	AMBH26540-MB	AMBH26540-PSS	AMBH26540-SS	Tissue Roll Holder	-	7-1/4"	2-3/4"
B	AMBH26541-BBZ	AMBH26541-MB	AMBH26541-PSS	AMBH26541-SS	Towel Ring	-	6-3/8"	2-1/8"
C	AMBH26542-BBZ	AMBH26542-MB	AMBH26542-PSS	AMBH26542-SS	Robe Hook	-	2"	2"
D	AMBH26543-BBZ	AMBH26543-MB	AMBH26543-PSS	AMBH26543-SS	Towel Bar, 18"	18"	21"	3-1/4"
E	AMBH26544-BBZ	AMBH26544-MB	AMBH26544-PSS	AMBH26544-SS	Towel Bar, 24"	24"	26-7/8"	3-1/3"
F	AMBH26545-BBZ	AMBH26545-MB	AMBH26545-PSS	AMBH26545-SS	Dble Towel Bar, 24"	24"	26-7/8"	5"
G	AMBH26546-BBZ	AMBH26546-MB	AMBH26546-PSS	AMBH26546-SS	Towel Bar, 9"	9"	11-5/8"	2-3/4"

A
B
C
D
E
F
G
H
I
J
K
L
M
N
O
P
Q
R
S
T
U
V
W
X
Y

A
B
C
D
E
F
G
H
I
J
K
L
M
N
O
P
Q
R
S
T
U
V
W
X
Y

WALL PLATES

Toggle Wall Plates, Candler Collection



A

B

C

D

Black Bronze Finish
Shown

Golden Champagne
Finish Shown

Satin Nickel Finish Shown

Oil Rubbed Bronze Finish Shown

	Black Bronze	Golden Champagne	Satin Nickel	Oil Rubbed Bronze	Type	Size	Projection
A	AMBP36500-BBR	AMBP36500-BBZ	AMBP36500-G10	AMBP36500-ORB	1-Gang	7.29"L x 4.73"W	0.25"
B	AMBP36501-BBR	AMBP36501-BBZ	AMBP36501-G10	AMBP36501-ORB	2-Gang	8.27"L x 6.3"W	0.25"
C	AMBP36502-BBR	AMBP36502-BBZ	AMBP36502-G10	AMBP36502-ORB	3-Gang	9.85"L x 6.3"W	0.25"
D	AMBP36503-BBR	AMBP36503-BBZ	AMBP36503-G10	AMBP36503-ORB	4-Gang	11.62"L x 6.3"W	0.25"

Rocker Wall Plates, Candler Collection



A

B

C

D

Black Bronze Finish
Shown

Golden Champagne
Finish Shown

Satin Nickel Finish Shown

Oil Rubbed Bronze Finish Shown

	Black Bronze	Golden Champagne	Satin Nickel	Oil Rubbed Bronze	Type	Size	Projection
A	AMBP36504-BBR	AMBP36504-BBZ	AMBP36504-G10	AMBP36504-ORB	1-Gang	7.29"L x 4.73"W	0.25"
B	AMBP36505-BBR	AMBP36505-BBZ	AMBP36505-G10	AMBP36505-ORB	2-Gang	8.27"L x 6.3"W	0.25"
C	AMBP36506-BBR	AMBP36506-BBZ	AMBP36506-G10	AMBP36506-ORB	3-Gang	9.85"L x 6.3"W	0.25"
D	AMBP36507-BBR	AMBP36507-BBZ	AMBP36507-G10	AMBP36507-ORB	4-Gang	11.62"L x 6.3"W	0.25"

WALL PLATES

Receptacle & Combo Wall Plates, Mulholland Collection



A

Black Bronze Finish Shown



B

Golden Champagne Finish Shown



C

Satin Nickel Finish Shown



D

Oil Rubbed Bronze Finish Shown

	Black Bronze	Golden Champagne	Satin Nickel	Oil Rubbed Bronze	Length	Width	Projection
Receptacle, 1-Gang							
A	AMBP36522-BBR	AMBP36522-BBZ	AMBP36522-G10	AMBP36522-ORB	7.29"L	4.73"W	0.25"
Receptacle, 2-Gang							
B	AMBP36523-BBR	AMBP36523-BBZ	AMBP36523-G10	AMBP36523-ORB	8.27"L	6.3"W	0.25"
(1) Receptacle + (1) Toggle, 2-Gang							
C	AMBP36524-BBR	AMBP36524-BBZ	AMBP36524-G10	AMBP36524-ORB	8.27"L	6.3"W	0.25"
(1) Receptacle + (1) Rocker, 2-Gang							
D	AMBP36525-BBR	AMBP36525-BBZ	AMBP36525-G10	AMBP36525-ORB	8.27"L	6.3"W	0.25"

Cable & Blank Wall Plates, Mulholland Collection



A

Satin Nickel Finish Shown



B

Oil Rubbed Bronze Finish Shown

	Satin Nickel	Oil Rubbed Bronze	Description	Length	Width	Projection
A	AMBP36526-G10	AMBP36526-ORB	Cable, 1-Gang	7.29"	4.73"	0.25"
B	AMBP36527-G10	AMBP36527-ORB	Blank, 1-Gang	7.29"	4.73"	0.25"

A WALL PLATES

**Toggle Wall Plates,
Mulholland Collection**



A Black Bronze Finish Shown B Golden Champagne Finish Shown C Satin Nickel Finish Shown D Oil Rubbed Bronze Finish Shown

	Black Bronze	Golden Champagne	Satin Nickel	Oil Rubbed Bronze	Type	Size	Projection
A	AMBP36514-BBR	AMBP36514-BBZ	AMBP36514-G10	AMBP36514-ORB	1-Gang	7.29"L x 4.73"W	0.25"
B	AMBP36515-BBR	AMBP36515-BBZ	AMBP36515-G10	AMBP36515-ORB	2-Gang	8.27"L x 6.3"W	0.25"
C	AMBP36516-BBR	AMBP36516-BBZ	AMBP36516-G10	AMBP36516-ORB	3-Gang	9.85"L x 6.3"W	0.25"
D	AMBP36517-BBR	AMBP36517-BBZ	AMBP36517-G10	AMBP36517-ORB	4-Gang	11.62"L x 6.3"W	0.25"

**Rocker Wall Plates,
Mulholland Collection**



A Black Bronze Finish Shown B Golden Champagne Finish Shown C Satin Nickel Finish Shown D Oil Rubbed Bronze Finish Shown

	Black Bronze	Golden Champagne	Satin Nickel	Oil Rubbed Bronze	Type	Size	Projection
A	AMBP36518-BBR	AMBP36518-BBZ	AMBP36518-G10	AMBP36518-ORB	1-Gang	7.29"L x 4.73"W	0.25"
B	AMBP36519-BBR	AMBP36519-BBZ	AMBP36519-G10	AMBP36519-ORB	2-Gang	8.27"L x 6.3"W	0.25"
C	AMBP36520-BBR	AMBP36520-BBZ	AMBP36520-G10	AMBP36520-ORB	3-Gang	9.85"L x 6.3"W	0.25"
D	AMBP36521-BBR	AMBP36521-BBZ	AMBP36521-G10	AMBP36521-ORB	4-Gang	11.62"L x 6.3"W	0.25"

WALL PLATES

Receptacle & Combo Wall Plates, Candler Collection



A

Black Bronze Finish Shown



B

Golden Champagne Finish Shown



C

Satin Nickel Finish Shown



D

Oil Rubbed Bronze Finish Shown

	Black Bronze	Golden Champagne	Satin Nickel	Oil Rubbed Bronze	Length	Width	Projection
Receptacle, 1-Gang							
A	AMBP36508-BBR	AMBP36508-BBZ	AMBP36508-G10	AMBP36508-ORB	7.29"L	4.73"W	0.25"
Receptacle, 2-Gang							
B	AMBP36509-BBR	AMBP36509-BBZ	AMBP36509-G10	AMBP36509-ORB	8.27"L	6.3"W	0.25"
(1) Receptacle + (1) Toggle, 2-Gang							
C	AMBP36510-BBR	AMBP36510-BBZ	AMBP36510-G10	AMBP36510-ORB	8.27"L	6.3"W	0.25"
(1) Receptacle + (1) Rocker, 2-Gang							
D	AMBP36511-BBR	AMBP36511-BBZ	AMBP36511-G10	AMBP36511-ORB	8.27"L	6.3"W	0.25"

Cable & Blank Wall Plates, Candler Collection



A

Satin Nickel Finish Shown



B

Oil Rubbed Bronze Finish Shown

	Satin Nickel	Oil Rubbed Bronze	Description	Length	Width	Projection
A	AMBP36512-G10	AMBP36512-ORB	Cable, 1-Gang	7.29"	4.73"	0.25"
B	AMBP36513-G10	AMBP36513-ORB	Blank, 1-Gang	7.29"	4.73"	0.25"

A
B
C
D
E
F
G
H
I
J
K
L
M
N
O
P
Q
R
S
T
U
V
W
X
Y

WALL PLATES

Toggle Wall Plates, Sea Grass Collection



A

B

C

D

Satin Nickel Finish Shown Oil Rubbed Bronze Finish Shown

Satin Nickel Finish Shown

Oil Rubbed Bronze Finish Shown

	Satin Nickel	Oil Rubbed Bronze	Description	Length	Width	Projection
A	AMBP36528-G10	AMBP36528-ORB	Toggle, 1-Gang	7.29"	4.73"	0.25"
B	AMBP36529-G10	AMBP36529-ORB	Toggle, 2-Gang	8.27"	6.3"	0.25"
C	AMBP36530-G10	AMBP36530-ORB	Toggle, 3-Gang	9.85"	6.3"	0.25"
D	AMBP36531-G10	AMBP36531-ORB	Toggle, 4-Gang	11.62"	6.3"	0.25"

Rocker Wall Plates, Sea Grass Collection

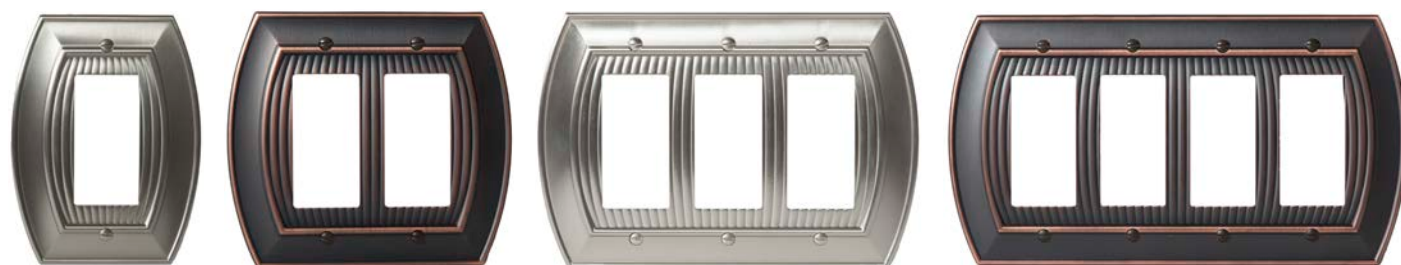

A

B

C

D

Satin Nickel Finish Shown Oil Rubbed Bronze Finish Shown

Satin Nickel Finish Shown

Oil Rubbed Bronze Finish Shown

	Satin Nickel	Oil Rubbed Bronze	Description	Length	Width	Projection
A	AMBP36532-G10	AMBP36532-ORB	Rocker, 1-Gang	7.29"	4.73"	0.25"
B	AMBP36533-G10	AMBP36533-ORB	Rocker, 2-Gang	8.27"	6.3"	0.25"
C	AMBP36534-G10	AMBP36534-ORB	Rocker, 3-Gang	9.85"	6.3"	0.25"
D	AMBP36535-G10	AMBP36535-ORB	Rocker, 4-Gang	11.62"	6.3"	0.25"

WALL PLATES

**Receptacle & Combo Wall Plates,
Sea Grass Collection**



A

Satin Nickel Finish Shown



B

Oil Rubbed Bronze Finish Shown



C

Satin Nickel Finish Shown



D

Oil Rubbed Bronze Finish Shown

	Satin Nickel	Oil Rubbed Bronze	Description	Length	Width	Projection
A	AMBP36536-G10	AMBP36536-ORB	Receptacle, 1-Gang	7.29"	4.73"	0.25"
B	AMBP36537-G10	AMBP36537-ORB	Receptacle, 2-Gang	8.27"	6.3"	0.25"
C	AMBP36538-G10	AMBP36538-ORB	(1) Receptacle + (1) Toggle, 2-Gang	8.27"	6.3"	0.25"
D	AMBP36539-G10	AMBP36539-ORB	(1) Receptacle + (1) Rocker, 2-Gang	8.27"	6.3"	0.25"

**Cable & Blank Wall Plates,
Sea Grass Collection**



A

Satin Nickel Finish Shown



B

Oil Rubbed Bronze Finish Shown

	Satin Nickel	Oil Rubbed Bronze	Description	Length	Width	Projection
A	AMBP36540-G10	AMBP36540-ORB	Cable, 1-Gang	7.29"	4.73"	0.25"
B	AMBP36541-G10	AMBP36541-ORB	Blank, 1-Gang	7.29"	4.73"	0.25"

A
B
C
D
E
F
G
H
I
J
K
L
M
N
O
P
Q
R
S
T
U
V
W
X
Y

A
B
C
D
E
F
G
H
I
J
K
L
M
N
O
P
Q
R
S
T
U
V
W
X
Y

TOILET PARTITION HARDWARE

Toilet Partition Hardware Technical Information



Jacknob® Corp. has been supplying the highest quality partition hardware for over 40 years. The following pages depict just some of the items that are available from Würth Baer Supply's inventory. There are literally hundreds of additional items available on special order as well as other finishes (brass, polished brass and cast or stamped stainless steel). Special orders are shipped within 72 hours. Contact your territory representative or our inside sales department to receive a complete catalog of the products available.

About ADA Compliance: The American Disabilities Act (ADA) of 1992 was enacted to make accessible all areas of public, municipal and commercial buildings to the physically challenged. Public lavatories and restrooms require special consideration to comply with these new and vigorously enforced regulations. The Jacknob® Corporation has placed specific emphasis on thoroughly understanding and providing the correct hardware to satisfy these new laws, and is ready to supply what you need to come up to code. While their hardware meets or exceeds the new ADA guidelines, they and Würth Baer Supply do indemnify ourselves as corporate and individual entities against situations of installation and actions of others as beyond our control.

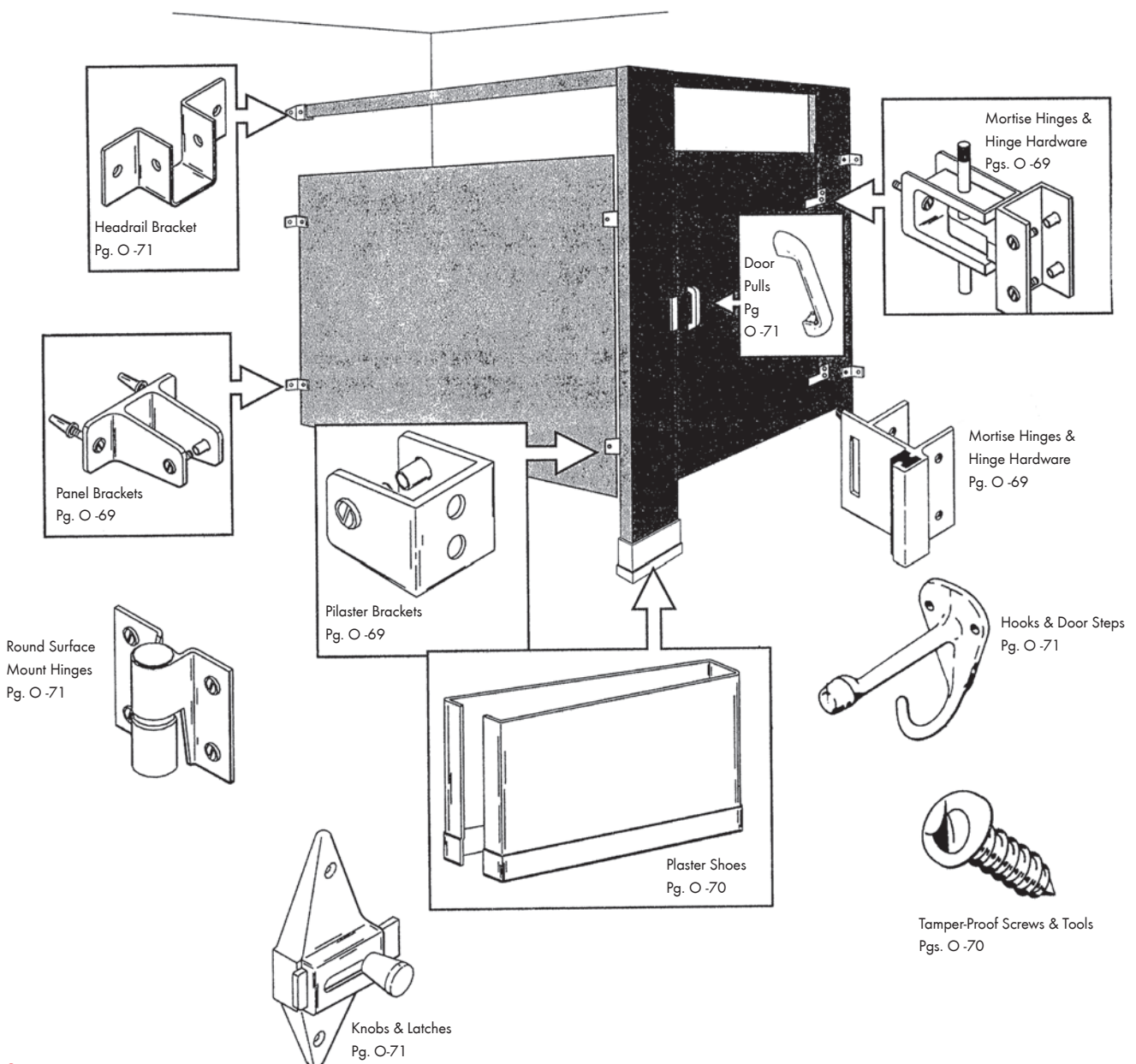

TOILET DOOR HARDWARE KIT



Mortise Hinge Kits - Swing-In & Swing-Out Versions

- In-swing means the partition door will swing in towards the toilet
- Out-swing means the partition door will swing away from the toilet
- Zamak with Chrome finish
- Mortise hinges provide 110° of opening
- All hardware kits will complete one door
- Mortise hinges are designed to be used on partitions/pilasters that are 1-1/4" thick
- All hardware kits are supplied with mounting screws

Item#	Door Thickness	Kits Include:
In-Swing		
JN17800	7/8" Door	(1)110° Top Hinge, (1)Top Insert, (1)110°Bottom Hinge, (1) Bottom Insert, (1) Hinge Pin, Strike/Keeper, (1)Latch, & (1) Hook
Out-Swing		
JN27800	7/8" Door	(1)110° Top Hinge, (1) Top Insert, (1)110°Bottom Hinge, (1) Bottom Insert, (1) Hinge Pin, Strike/Keeper, (1)Latch, (1) Hook & (1) Door Pull

Partition Bracket Kits

- All hardware kits include hardware and screws to install one panel, except for the headrail bracket, screws sold separately below
- Zamak material with Chrome finish

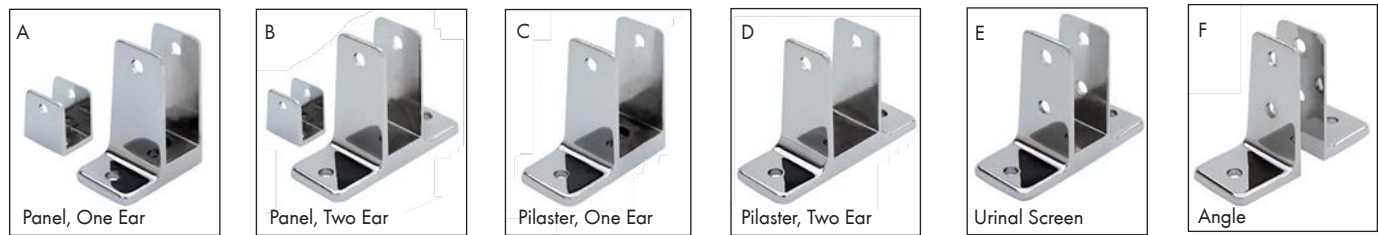

	Item#	Designed for Panel Thickness/ Number of Ears	Kit Includes
Panel Bracket Kits – Used To Attach Panel To Wall And Pilaster			
A	JN15090	For 7/8" Panel/One Ear Brackets	(2)Wall Brackets, (2)"U" Brackets & Mounting Screws
B	JN15020	For 7/8" Panel/Two Ear Brackets	(2)Wall Brackets, (2)"U" Brackets & Mounting Screws
Pilaster Bracket Kits – Used To Attach Pilaster To Wall			
C	JN15230	For 1-1/4" Pilaster/One Ear Brckts	(2)Wall Brackets & Mounting Screws
D	JN15220	For 1-1/4" Pilaster/Two Ear Brckts	(2)Wall Brackets & Mounting Screws
Urinal Screen Bracket Kits – Used For Wall Hung Screens			
E	JN15420	For 7/8" Screen/Two Ear Brackets	(3)Wall Brackets & Mounting Screws
Angle Bracket Kits – Used To Attach Panel To Wall			
F	JN15530	For Any Size Panel	(1)Wall Bracket & Mounting Screws

A
B
C
D
E
F
G
H
I
J
K
L
M
N
O
P
Q
R
S
T
U
V
W
X
Y

A
B
C
D
E
F
G
H
I
J
K
L
M
N
O
P
Q
R
S
T
U
V
W
X
Y

TOILET PARTITION HARDWARE

Toilet Partition Hardware

- One-Way slotted screws can only be removed with one-way screw removers
- All screws and barrel nuts are made of steel and have a chrome plated finish

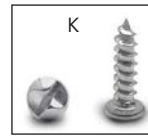
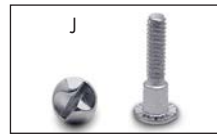
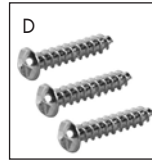

Item#	Description	Includes
Screw Packs – Sold in Pack		
A	JN10 1-1/4" Hinge or Strike and Keeper	(2) JN9713 5/8" One-Way Barrel Nuts & (2) JN9813 1-3/16" One-Way Shoulder Screws
B	JN20 For 1" Wall Brackets	(2) JN9015 Plastic Anchors, (2) JN9713 5/8" One-Way Barrel Nuts, (2) JN9793 15/16" One-Way Shoulder Screws, (2) JN91353 #12 X 5/8" Pan Head Screws, & (2) JN91533 #12 X 1-1/2" Pan Head Screws
C	JN50 For JN5020 Surface Mount Latch	(2) JN9423 8-32 X 1" One-Way Machine Screws, (2) JN9443 8-32 x 1-1/8" One-Way Machine Screws, & (2) JN9763 5/8" Un-Slotted Barrel Nuts
D	JN100 Hooks and Door Stops	(3) JN9203 #10 X 1" One-Way Tapping Screws
One-Way Screw Removers – Sold in Each		
	JN8925 One-Way Screw Remover	Can remove sizes 8-10
E	JN8935 One-Way Screw Remover	Can remove sizes 12-14
	JN8905 One-Way Screw Remover – 3 Pack	(1) JN8915* (Sizes 6-8), (1) JN8925 (Sizes 8-10) & (1) JN8935 (Sizes 12-14)
Pilaster Post Shoe Kit		
F	JN30810 Pilaster Post Shoe Kit For 1-1/4" Pilaster - (2) Post Shoes and all necessary hardware and screws to install one panel	
	JN30999 (2) 3"H x 10"L Spacer Plates - Made of Stainless Steel with a Stainless Steel finish	
Tissue Holders		
G	JN7359 3-1/2" c/c Screw Hole, Single Tissue Holder (2-11/16"H x 5-7/8"L x 4" Projection, Made of Steel, Chrome Finish)	
H	JN7369 3-1/2" c/c Screw Hole, Double Tissue Holder (2-11/16"H x 11"L x 4" Projection, Made of Steel, Chrome Finish)	

Barrel Nuts – One-Way Slotted Truss Head, 10-24 Thread (Bag Qty Only)				Bag Qty
I	JN9703	One-Way Slotted Barrel Nuts	1/2" L x 3/8" Thread Depth	100
	JN9713	One-Way Slotted Barrel Nuts	5/8" L x 1/2" Thread Depth	100
Shoulder Screws – One-Way Slotted Truss Head, 10-24 Thread (Bag Qty Only)				Bag Qty
	JN9783	One-Way Slotted Shoulder Screws	3/4" Length	100
J	JN9813	One-Way Slotted Shoulder Screws	1-3/16" Length	100
	JN9823	One-Way Slotted Shoulder Screws	1-5/16" Length	100
Sheet Metal Screws – One-Way Slotted Round Head, Type A (Bag Qty Only)				Bag Qty
K	JN9173	One-Way Slotted Sheet Metal Screw	#10 x 5/8"	100

TOILET DOOR HARDWARE

Headrail & Brackets

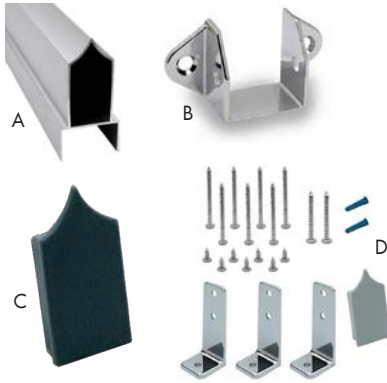

	Item #	Description	Material / Finish
A	JN80152	10' Headrail for 1-1/4" post	Anodized Aluminum/ Aluminum
B	JN2170	1-1/4" headrail wall bracket	Zamak / Chrome
C	JN6675	End Cap for headrails	Nylon / Gray
D	JN15790	Corner Bracket Kit for Headrail Includes: (3) "L" Brackets, (1) End Cap, & Mounting Screws	Zamak / Chrome

Toilet Door Hardware Components



	Item#	Description	Door Type	Material/ Finish	For Door Thickness	For Pilaster Size
A	JN7011	Surface Mount Hinges	Right Hand In-Swing / Left Hand Out-Swing	Brass/Chrome Plated	-	-
	JN7021	Surface Mount Hinges	Left Hand In-Swing / Right Hand Out-Swing	Brass/Chrome Plated	-	-
B	JN1540	Mortise Top Insert	In-Swing/Out-Swing	Zamak/Chrome	7/8"	1-1/4"
C	JN1530	Mortise Bottom Insert	In-Swing/Out-Swing	Zamak/Chrome	7/8"	1-1/4"
D	JN5110	Strike/Keeper	In-Swing	Zamak/Chrome	7/8" & 1"	1-1/4"
E	JN5210	Strike/Keeper	Out-Swing	Zamak/Chrome	7/8" & 1"	1-1/4"
F	JN5020	Latch	In-Swing/Out-Swing	Zamak/Chrome	7/8" & 1"	1-1/4"
G	JN4000	Single Prong Hook	In-Swing	Zamak/Chrome	7/8" & 1"	1-1/4"
H	JN4020	Double Prong Hook	Out-Swing	Zamak/Chrome	7/8" & 1"	1-1/4"
I	JN6200	Door Pull	Out-Swing	Zamak/Chrome	7/8" & 1"	1-1/4"
J	JN50	Screws for Latch, (2) 1" Screws, (2) 1-1/8" Screws & (2) 5/8" Barrel Nuts		Zamak/Chrome	-	-
K	JN10	Screw Pack for Strike/Keepers, (2) 5/8" Barrel Nuts & (2) 1- 3/16" Shoulder Screws		Zamak/Chrome	-	-

A
B
C
D
E
F
G
H
I
J
K
L
M
N
O
P
Q
R
S
T
U
V
W
X
Y

A
B
C
D
E
F
G
H
I
J
K
L
M
N
O
P
Q
R
S
T
U
V
W
X
Y

BAR & FOOT RAILING ACCESSORIES



1-1/2" & 2" Dia. Solid Brass/Stainless Steel Railing



- Bright Brass finish is made of solid brass
- Satin Stainless Steel finish is made of 304 stainless steel, rust resistant
- Railing is 3/64" thick
- Bar railing sleeves have an inside friction fit which tightly connects two lengths of railing together
- Sleeves are sold separately below

	Dimensions	Length	Bright Brass Item#
A	1-1/2" Dia. x 3/64" Thick	8'	BC110-96
	1-1/2" Dia. x 3/64" Thick	12'	BC110-144
	2" Dia. x 3/64" Thick	4'	BC120-48
	2" Dia. x 3/64" Thick	6'	BC120-72
	2" Dia. x 3/64" Thick	8'	BC120-96
	2" Dia. x 3/64" Thick	12'	BC120-144
B	Sleeve Item #	Description	
	BC830-1H	1-1/2" diameter sleeve connector	
	BC830-2	2" diameter sleeve connector	

	Dimensions	Length	Satin Stainless Steel Item#
A	1-1/2" Dia. x 3/64" Thick	8'	BC110-96SS
	1-1/2" Dia. x 3/64" Thick	12'	BC110-144SS
	2" Dia. x 3/64" Thick	4'	BC120-48SS
	2" Dia. x 3/64" Thick	6'	BC120-72SS
	2" Dia. x 3/64" Thick	8'	BC120-96SS
	2" Dia. x 3/64" Thick	12'	BC120-144SS
B	Sleeve Item #	Description	
	BC830-1H	1-1/2" diameter sleeve connector	
	BC830-2	2" diameter sleeve connector	

A - Full Round



B - Cut Flanges



Bar Railing Wall & Cut Flanges Stainless Steel



- Satin Stainless Steel finish is made of 304 stainless steel
- Screws included

	Dimensions	Fits Railing Dia.	Item#
Full Round Flanges			
A	3"D x 1-1/4"H	1-1/2"	BC510-1HSS
	4"D x 1-1/4"H	2"	BC530-2SS
Cut Flanges			
B	4"D x 2-1/2"W	2"	BC531-2SS

BAR & FOOT RAILING ACCESSORIES

Solid Brass & Stainless Steel Footrails



- Bright Brass finish is made of solid brass
- Satin Stainless Steel finish is made of 304 stainless steel
- 4' spacing between brackets is recommended
- Sold with screws

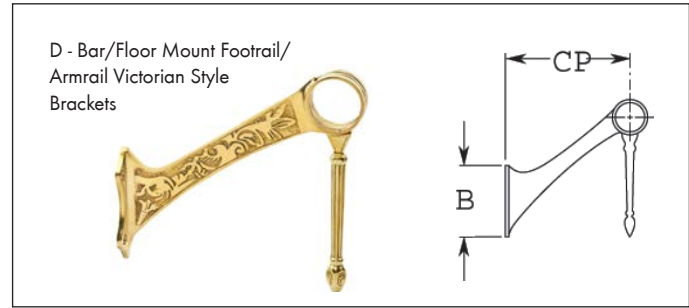
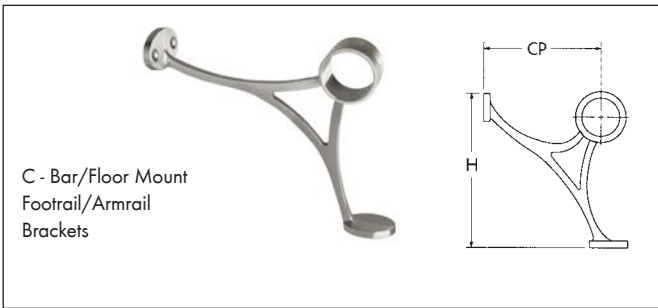
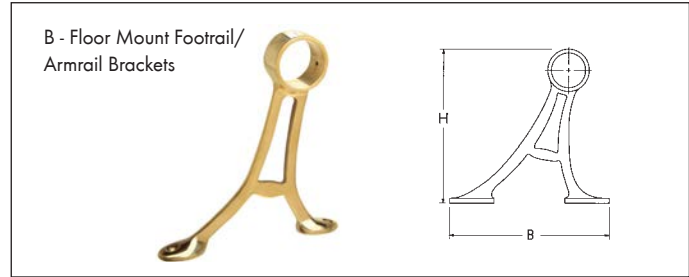
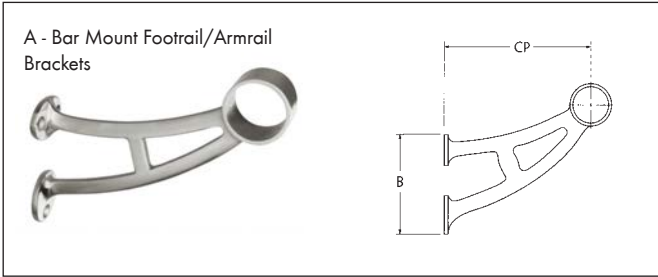

	Dimensions	Fits Railing Size	Bright Brass Item#	Satin Stainless Steel Item#
Bar Mount Footrail/Armrail Brackets				
A	6-1/16"CP x 4"B	1-1/2"	BC402-1H	BC402-1HSS
	6-7/8"CP x 4-1/4"B	2"	BC402-2	BC402-2SS
Floor Mount Footrail/Armrail Brackets				
B	6"CP x 6-5/16"B	1-1/2"	BC404-1H	-
	6-1/8"CP x 6-11/16"B	2"	BC404-2	-
Bar/Floor Mount Footrail/Armrail Brackets				
C	6-7/16"CP x 6-5/8"H	1-1/2"	BC400-1H	BC400-1HSS
	6-1/8"CP x 7"H	2"	BC400-2	BC400-2SS
Bar/Floor Mount Footrail/Armrail Bracket - Victorian				
D	8-1/8"CP x 4-11/16"B	2"	BC410-2	-

A
B
C
D
E
F
G
H
I
J
K
L
M
N
O
P
Q
R
S
T
U
V
W
X
Y

A BAR RAILING ACCESSORIES

B
C
D
E
F
G
H
I
J
K
L
M
N
O
P
Q
R
S
T
U
V
W
X
Y

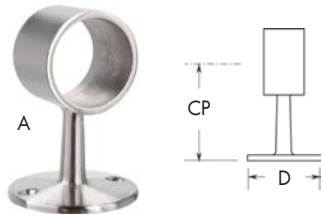

Bar Railing Handrail/Post Brackets



- Bright Brass finish is made of solid brass
- Satin Stainless Steel finish is made of 304 stainless steel
- Sold with screws

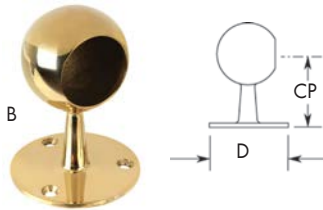

	Dimensions	Railing Size	Bright Brass Item#	Satin Stainless Steel Item#
Flush Center Post				
A	2-7/16"CP x 2-5/16"D	1-1/2"	BC342-1HPB	BC342-1HSS
Ball End Post				
B	2-3/4"CP x 2-15/16"D	1-1/2"	BC330-1H	-
Ball Center Post				
C	5"CP x 3-1/4"D	2"	BC336-2	-
Standard Handrail Bracket				
D	2-1/2"CP x 2-1/2"D	1-1/2"	BC301-1H	BC301-1HSS
	2-3/4"CP x 2-1/2"D	2"	BC301-2	BC301-2SS

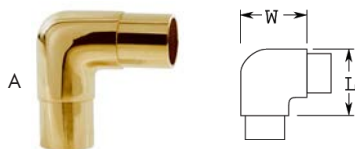

**Bar Railing Flush & Ball Fittings
Solid Brass & Stainless Steel**



- Bright Brass finish is made of solid brass
- Satin Stainless Steel finish is made of 304 stainless steel

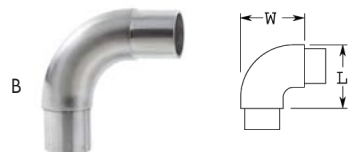

	Dimensions	Fits Railing Size	Bright Brass Item#	Satin Stainless Steel Item#
90° Ell Flush Fittings				
A	2"W x 2"L	1-1/2"	BC732-1H	-
	2-1/2"W x 2-1/2"L	2"	BC732-2	BC732-2SS
Radius Ell Flush Fittings				
B	2-7/8"W x 2-7/8"L	1-1/2"	-	BC731-1HSS
	3"W x 3"L	2"	-	BC731-2SS
135° Angle Flush Fittings				
C	2-15/16"W x 3"L	1-1/2"	BC730-1H	BC730-1HSS
	2-7/8"W x 3-3/8"L	2"	BC730-2	BC730-2SS
Ball 90° Ell Traditional Fittings				
D	2-1/2"D x 2-3/4"L	1-1/2"	BC702-1H	BC702-1HSS
	3-1/4"D x 3-1/4"L	2"	BC702-2	BC702-2SS

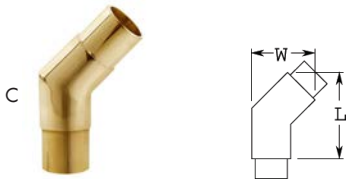

BAR/FOOT RAILING ACCESSORIES

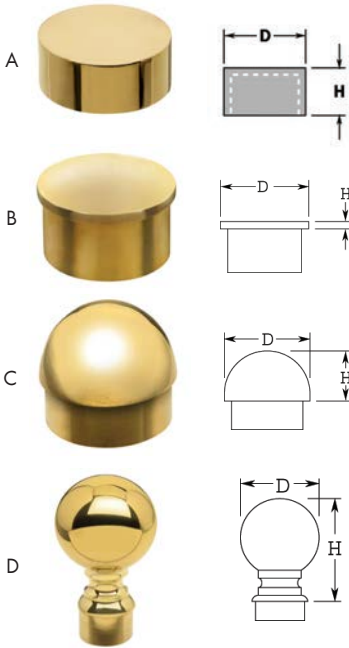

**Bar Railing End Caps & Finials
Solid Brass & Stainless Steel**



- Caps the open rail ends of handrails and footrails
- Bright Brass finish is made of solid brass
- Satin Stainless Steel finish is made of 304 stainless steel

Bright Brass Finish			
	Dimensions	Railing Size	Item#
Outer End Cap			
A	2-1/8"D x 7/8"H	2"	BC600W-2
Inner End Cap			
B	1-1/2"D x 1/8"H	1-1/2"	BC600-1H
	2"D x 1/8"H	2"	BC600-2
Half Ball End Cap			
C	1-1/2"D x 3/4"H	1-1/2"	BC602-1H
	2"D x 1"H	2"	BC602-2
Ball Finials			
D	2-5/8"D x 3-1/4"H	1-1/2"	BC604-1H
	3-1/8"D x 4-1/2"H	2"	BC604-2
Satin Stainless Steel Finish			
	Dimensions	Railing Size	Item#
Inner End Cap			
B	1-1/2"D x 1/8"H	1-1/2"	BC600-1HSS
	2"D x 1/8"H	2"	BC600-2SS
Half Ball End Cap			
C	1-1/2"D x 3/4"H	1-1/2"	BC602-1HSS
	2"D x 1"H	2"	BC602-2SS

**Brass Bar Railing
Accessories**



A

B

	Item#	Description
Metal Polish		
A	BC202	Metal polish used to repolish uncoated brass, aluminum and stainless steel (6.33 oz. tube)
Contact Cement		
B	BC201	Contact cement used to firmly adhere solid brass connections. Anaerobic cement sets in the absence of air - container is only half full (1 oz.)

A
B
C
D
E
F
G
H
I
J
K
L
M
N
O
P
Q
R
S
T
U
V
W
X
Y

BAR/FOOT RAILING KITS

Hand & Foot Rail Kits, 1-1/2" & 2" Diameter Tubing



- Handrail kits feature 1-1/2" diameter tubing while foot rail kits include 2" diameter rails
- Kits include all material necessary to construct 8' or 12' long straight railing system
- Hand and foot rail kits are available in Bright Brass and Satin Stainless Steel finishes
- All kit components are securely packaged together in a single box to provide convenient transport to the job site and easy assembly/installation

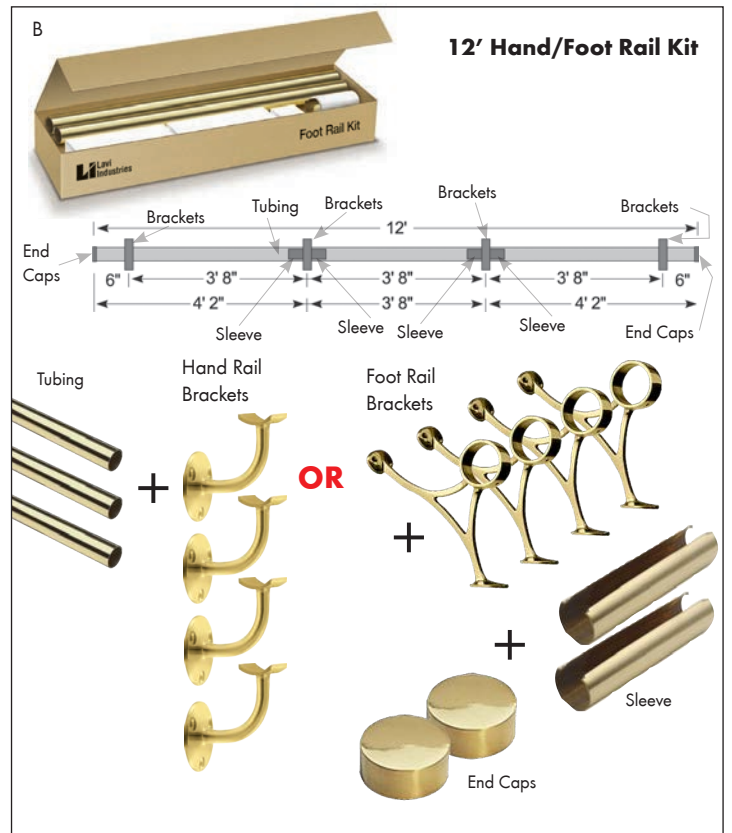
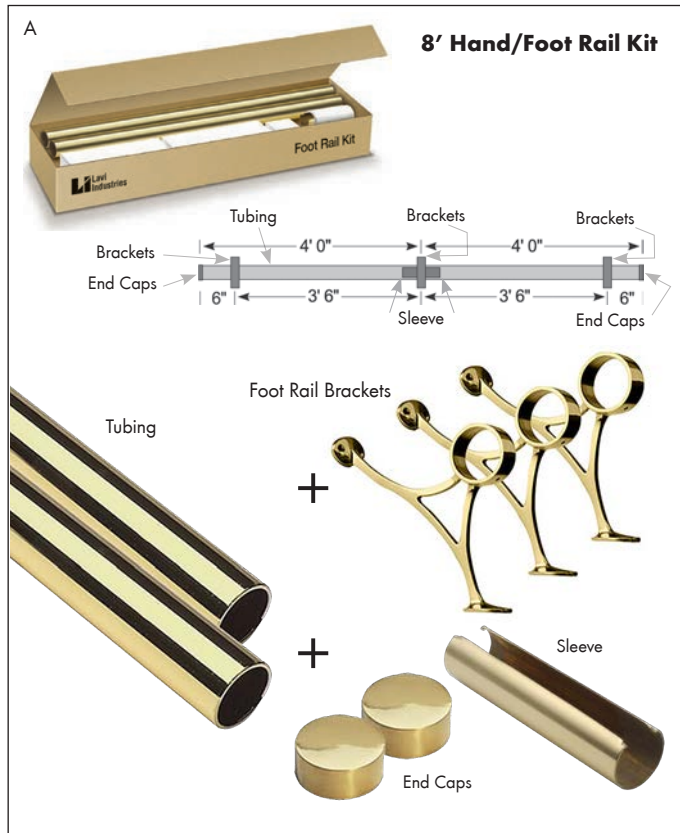

	Bright Brass Item#	Stainless Steel Item#	Description	Kit Includes
A	BC00-FR1008-2	BC44-FR1008-2	8' Foot Rail Kit	(2) 2" Dia. x 4'L Rails, (3) Brackets, (1) Internal Sleeve, & (2) End Caps
B	BC00-HR1012-1H	BC44-HR1012-1H	12' Hand Rail Kit	(1) 1-1/2" Dia. X 3'8"L Rail, (2) 1-1/2" Dia. X 4'2" Rails, (4) Brackets, (2) Internal Sleeves, & (2) End Caps
	BC00-FR1012-2	BC44-FR1012-2	12' Foot Rail Kit	(1) 2" Dia. x 3'8" L Rail, (2) 2" Dia. x 4'2" Rails, (4) Brackets, (2) Internal Sleeves, & (2) End Caps



C



D

Accessories	
Item #	Description
C	BC202 Metal polish used to re-polish uncoated brass, aluminum and stainless steel (6.33 oz. tube)
D	BC201 Contact cement used to firmly adhere solid brass connections. Anaerobic cement sets in the absence of air - container is only half full (1 oz.)